





ASSEMBLY INSTRUCTION
ITEM NO: 194S8341BL/GY-1RV
CHAIR

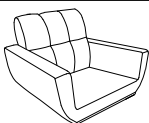
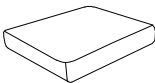

Legs & hardware are stored under the seat cushion, please take out the legs and hardware for assembly.

Note: Do not use power tools for assembly. Power tools increase the risk of over tightening which lead to splitting or cracking the wood.

Component list

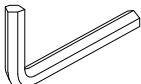
No	Drawing	Qty	Description
A		1	Chair
B		1	Seat cushion
C		1	Pillow
D		4	Wooden legs (Ø40*Ø35*148mm)
E		12	Bolt (1/4*25mm)
F		1	Allen key (M4*59mm)

THE PARTS ARE LOCATED INSIDE THE BOX AS BELOW:

WOODEN LEGS

HARDWARE

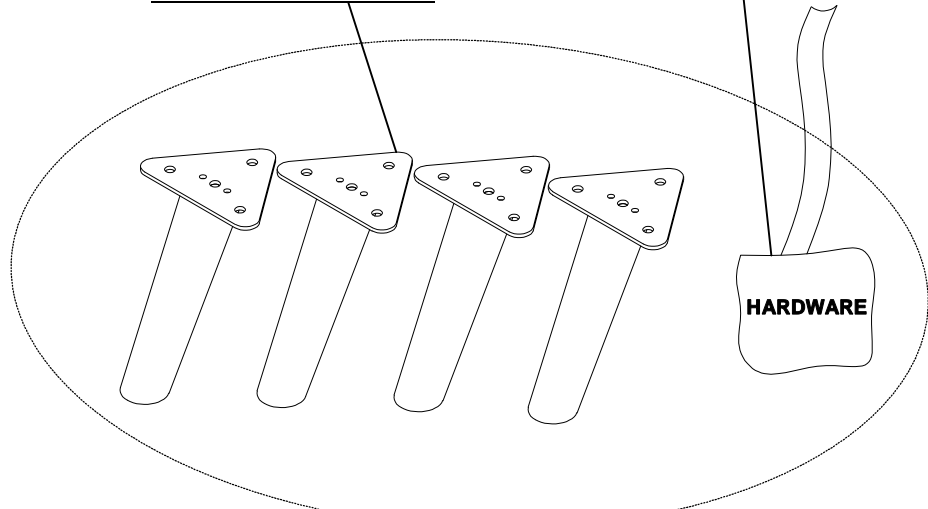

**WOODEN LEGS AND
HARDWARE
STORE UNDER THE
SEAT CUSHION**

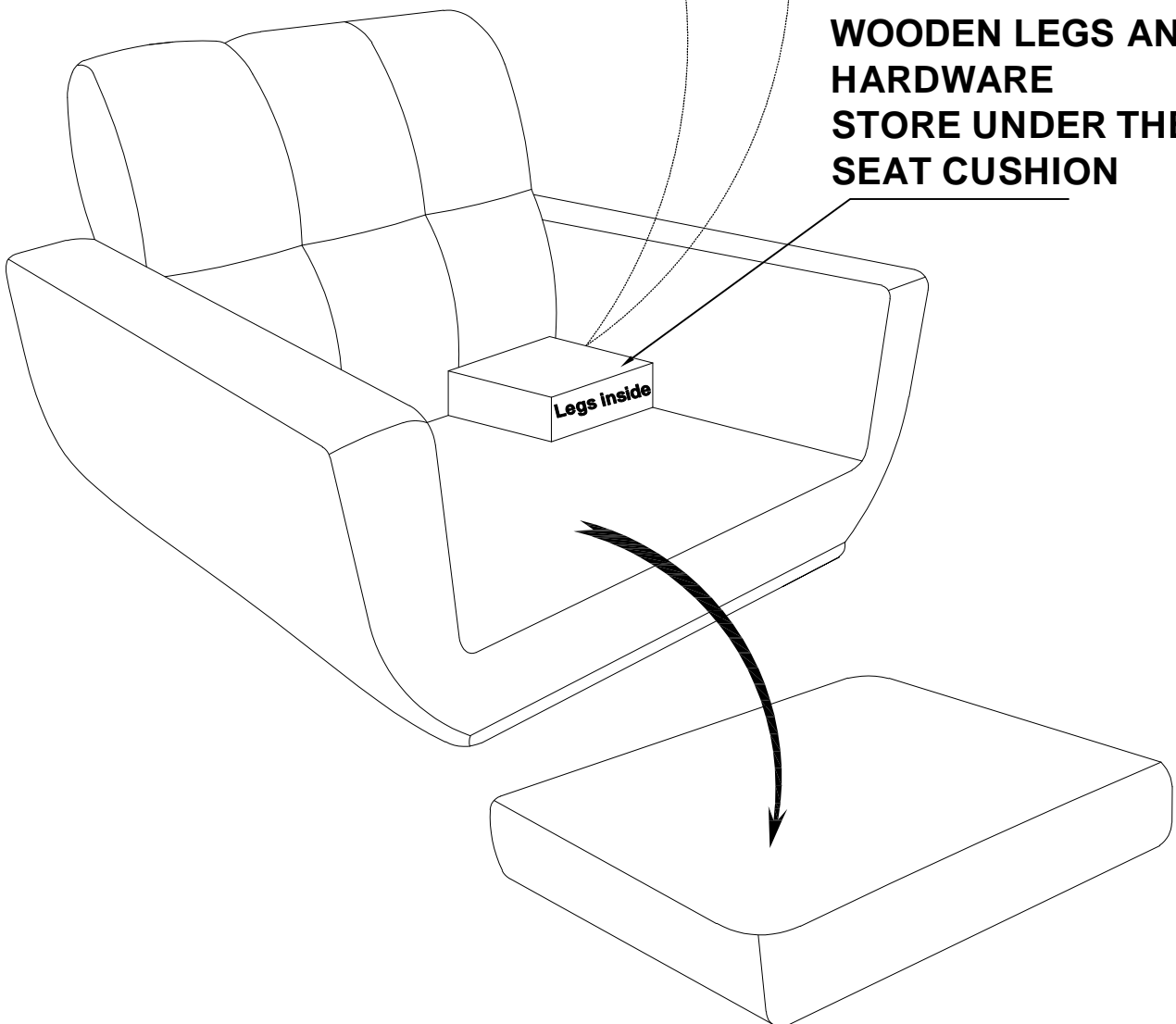

Step #1

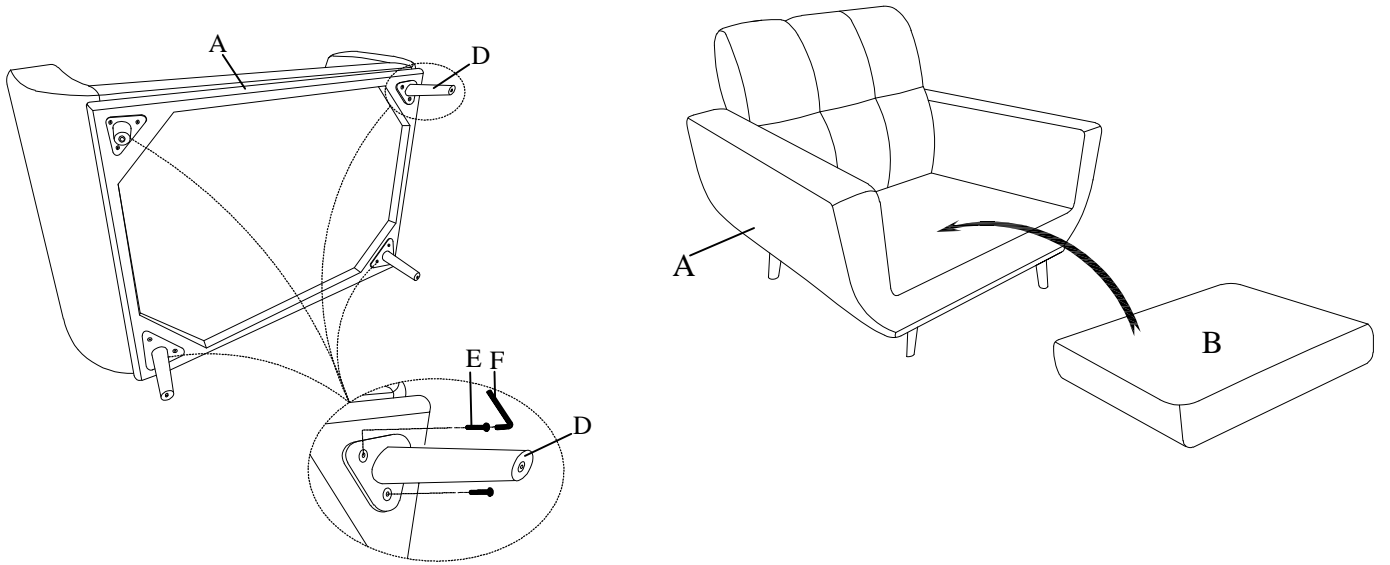

Step #2

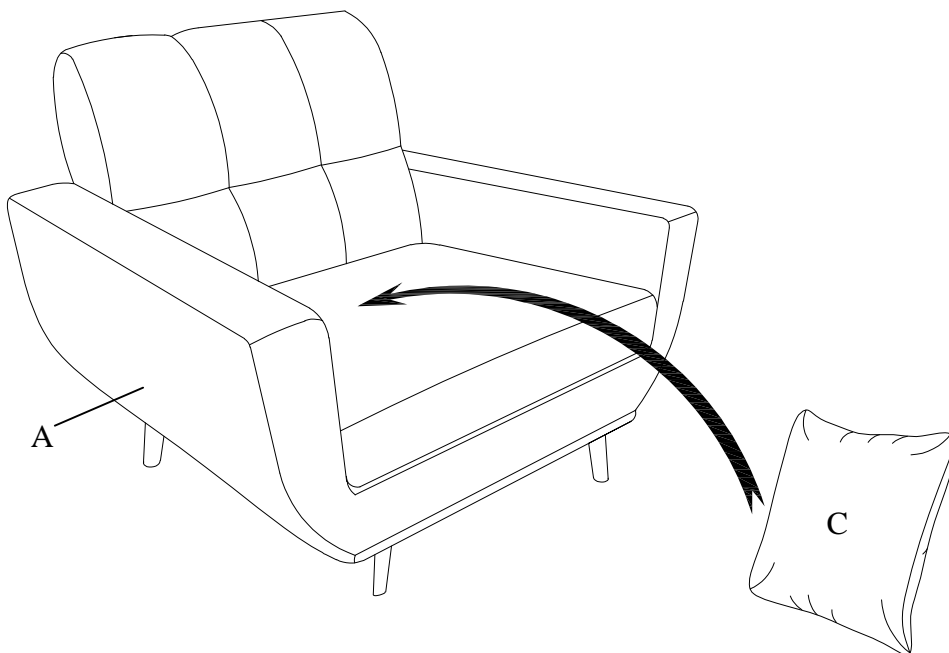

Step #3

Assembly completed.

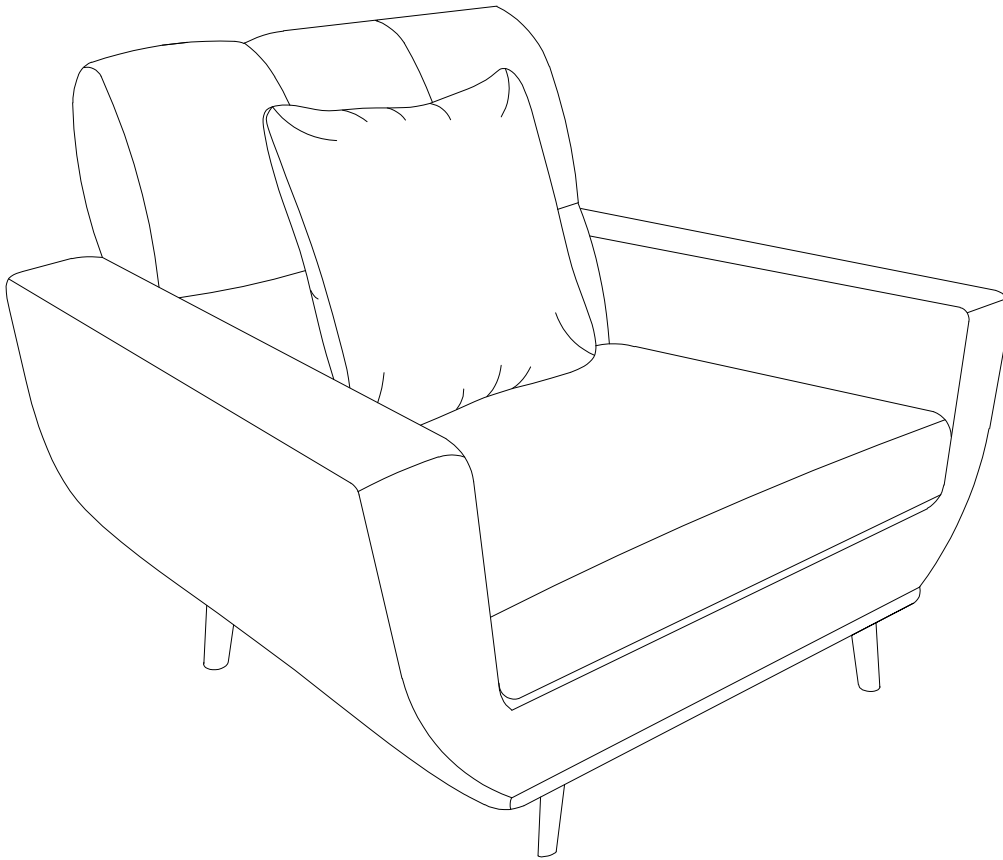

Care Instruction for chenille fabric Furniture:

In order to maintain the original appearance of your chenille fabric, please follow below simple care procedures:

- **Avoid exposing furniture directly to sunlight or heating and air conditioning outlets. Sunlight and/or exposure to heating and air conditioning outlets will fade/damage chenille fabrics. Do not place your upholstered furniture too close to windows, radiators, or vents, and be sure to use windows, radiators, or vents.**
- **Vacuum or wipe with a soft cloth to remove dust.**
- **Hardware may loosen over time. Periodically check to make sure all connections are tight. Re-tighten if necessary.**



For items use on wooden floor, hard surfaces or carpets, it is recommended to Install protective pads under all legs and supports to avoid/prevent from damages/scratches and discoloration.