

## ASSEMBLY INSTRUCTION

### EK-CK Panel Headboard

### EK/CK Storage Footboard & Slats

### Side Rail

Thank you for purchasing this quality product. Be sure to check all packing material carefully for small parts which may have come loose inside the carton during shipment. Identify and count all parts and compare with the Parts List below.







For items use on wooden floor, hard surfaces or carpets, it is recommended to install protective pads under all legs and supports to avoid/ prevent from damages/ scratches and discoloration.





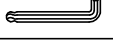

Pour les articles Utilisés sur un plancher en bois, des surfaces dures ou tapis, il est recommandé d'installer des mordaches de protection sous tous les jambes et prend en charge pour éviter/empêcher de dommages/ rayures et la décoloration.

#### HARDWARE LIST OF FOOTBOARD HARDWARE PACK IS IN-191B1820NK-2

NO.	DRAWING	DESCRIPTION	Q'TY
6		Φ5/16"*1-1/2" Bolt	8PCS
7		Φ5/16" Lock Washer	8PCS
8		Φ5/16"*19*2mm Flat Washer	8PCS
9		Φ5/16" Allen Key	1PC
10		#8*1" Screw	22PCS





#### HARDWARE LIST OF BED RAIL HARDWARE PACK IS IN-191B1820N-3

NO.	DRAWING	DESCRIPTION	Q'TY
11		Φ5/16"*3-1/2" Hanger Bolt	8PCS
12		Φ50 Arc Washer	8PCS
13		Φ5/16"*L17 Nut	8PCS
14		Φ5/16" Open Wrench	1PC

#### COMPONENT LIST

NO.	DESCRIPTION	Q'TY
A	HEADBOARD	1PC
B	HEADBOARD LSF LEG	1PC
C	HEADBOARD RSF LEG	1PC
D	HEADBOARD BOTTOM RAIL	1PC
E	FOOTBOARD	1PC
F	SUPPORT LEG (32*32*213mm)	4PCS
G	FOOTBOARD DRAWER (L&R)	2PCS
H	SIDE RAIL	2PCS
I	SLAT (11 PCS)	1SET
J	SLAT SUPPORT LEG LONG (32*32*395mm)	10PCS
K	SLAT SUPPORT LEG SHORT (32*32*189mm)	1PC

#### HARDWARE LIST OF HEADBOARD HARDWARE PACK IS IN-191B1820NK-1

NO.	DRAWING	DESCRIPTION	Q'TY
1		Φ5/16"*1-1/4" Bolt	6PCS
2		Φ5/16"*1-3/4" Bolt	2PCS
3		Φ5/16" Lock Washer	8PCS
4		Φ5/16"*19*2mm Flat Washer	8PCS
5		Φ5/16" Allen Key	1PC

# ASSEMBLY INSTRUCTION

## EK-CK Panel Headboard

## EK/CK Storage Footboard & Slats

### Side Rail

Thank you for purchasing this quality product. Be sure to check all packing material carefully for small parts which may have come loose inside the carton during shipment. Identify and count all parts and compare with the Parts List below.

**!** For items use on wooden floor, hard surfaces or carpets, it is recommended to install protective pads under all legs and supports to avoid/ prevent from damages/ scratches and discoloration.

**!** Pour les articles Utilisés sur un plancher en bois, des surfaces dures ou tapis, il est recommandé d'installer des mordaches de protection sous tous les jambes et prend en charge pour éviter/empêcher de dommages/raures et la décoloration.

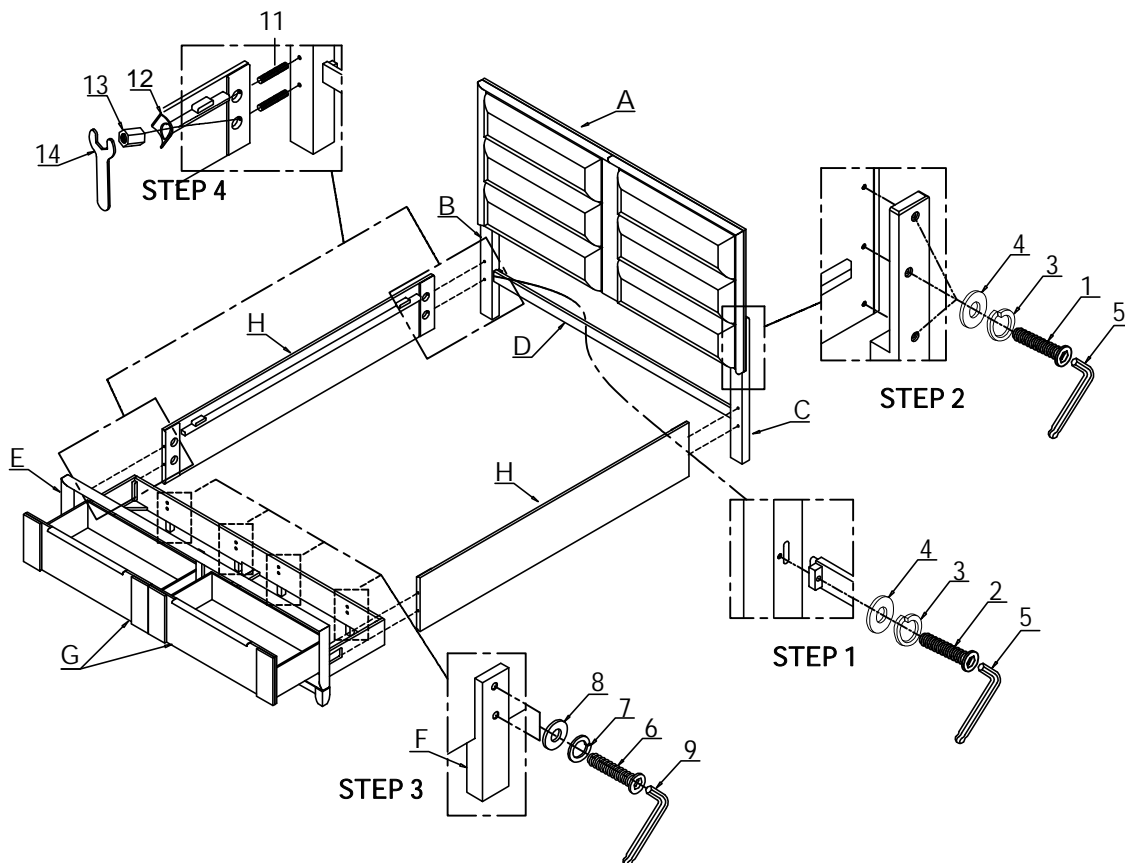

# ASSEMBLY INSTRUCTION

## EK-CK Panel Headboard

### EK/CK Storage Footboard & Slats

### Side Rail

Thank you for purchasing this quality product. Be sure to check all packing material carefully for small parts which may have come loose inside the carton during shipment. Identify and count all parts and compare with the Parts List below.

**!** For items use on wooden floor, hard surfaces or carpets, it is recommended to install protective pads under all legs and supports to avoid/ prevent from damages/ scratches and discoloration.

**!** Pour les articles Utilisés sur un plancher en bois, des surfaces dures ou tapis, il est recommandé d'installer des mordaches de protection sous tous les jambes et prend en charge pour éviter/empêcher de dommages/rayures et la décoloration.

