











ITEM NO : 191B1468-1#

ASSEMBLY INSTRUCTION









QUEEN BED

- (1/4) QUEEN HEADBOARD
- (2/4) QUEEN FOOTBOARD & SLATS
- (3/4) EASTERN KING /QUEEN SIDE RAILS
- (4/4) QUEEN/KING HEADBOARD POSTS

PART LIST

1		HEADBOARD PANEL	1 PC
2		HEADBOARD LSF POST	1 PC
3		HEADBOARD RSF POST	1 PC
4		HEADBOARD CROSS BAR	1 PC
5		FOOTBOARD	1 PC
6		FOOTBOARD TOP FINIAL	2 PCS
7		FOOTBOARD BUN FOOT	2 PCS
8		SIDE RAIL	2 PCS
9		SLAT	4 PCS
10		SUPPORT LEG	4 PCS

HARDWARE LIST IN-1Q

A		ALLEN KEY 5/16"	1 PC
B		BOLT 5/16"x1-3/4"	10 PCS
C		SPRING WASHER 5/16"	10 PCS
D		FLAT WASHER 5/16"	10 PCS
E		BOLT 5/16" x 3-1/4"	8 PCS
F		"C" WASHER 5/16"	8 PCS
G		HEX NUT 5/16"	8PCS
H		WRENCH 13x90MM	1 PC
I		WOOD SCREW #8 x 32MM	8 PCS

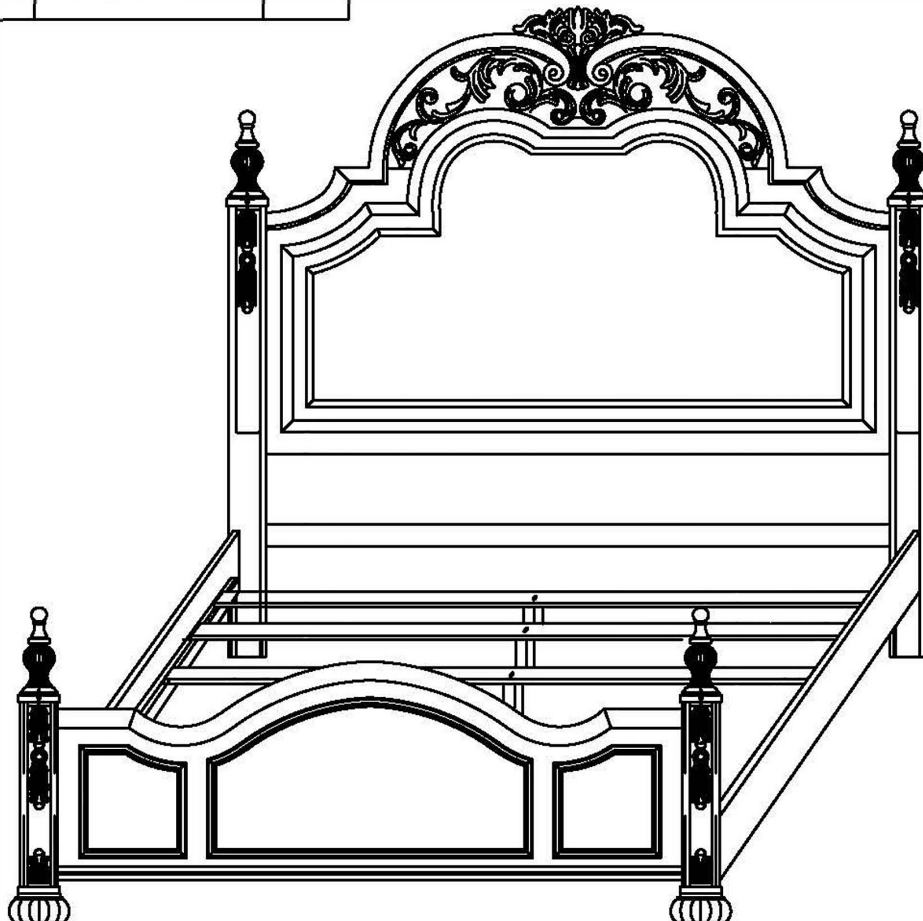

ASSEMBLY INSTRUCTION

QUEEN BED

- (1/4) QUEEN HEADBOARD
- (2/4) QUEEN FOOTBOARD & SLATS
- (3/4) EASTERN KING /QUEEN SIDE RAILS
- (4/4) QUEEN/KING HEADBOARD POSTS

STEP 1

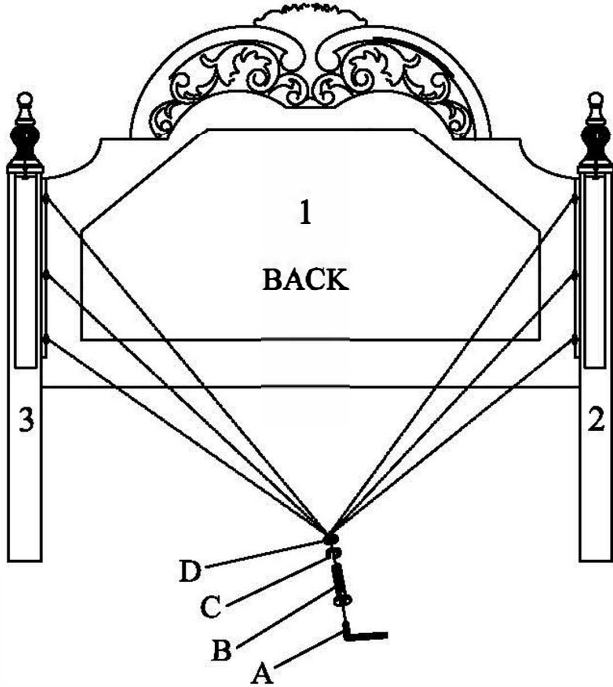

STEP 2

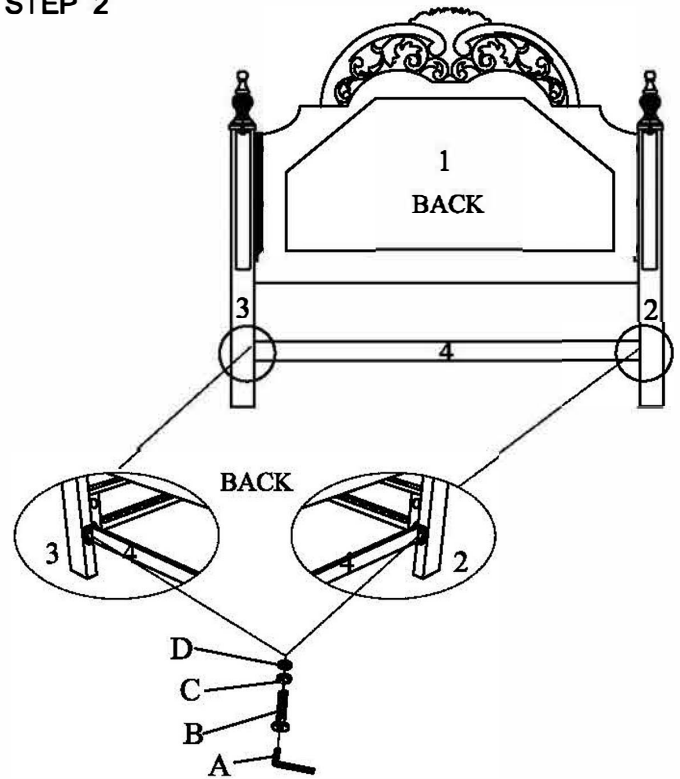

STEP 3

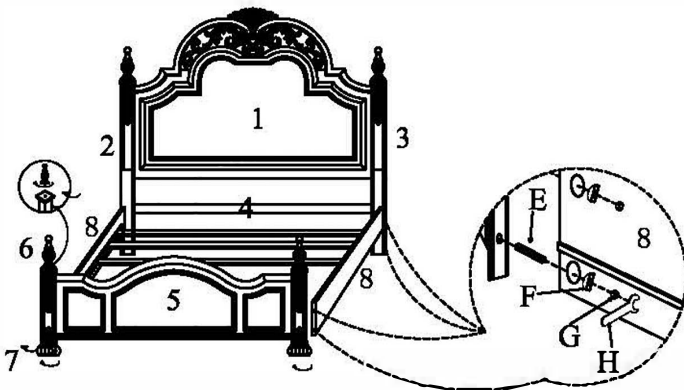

STEP 4

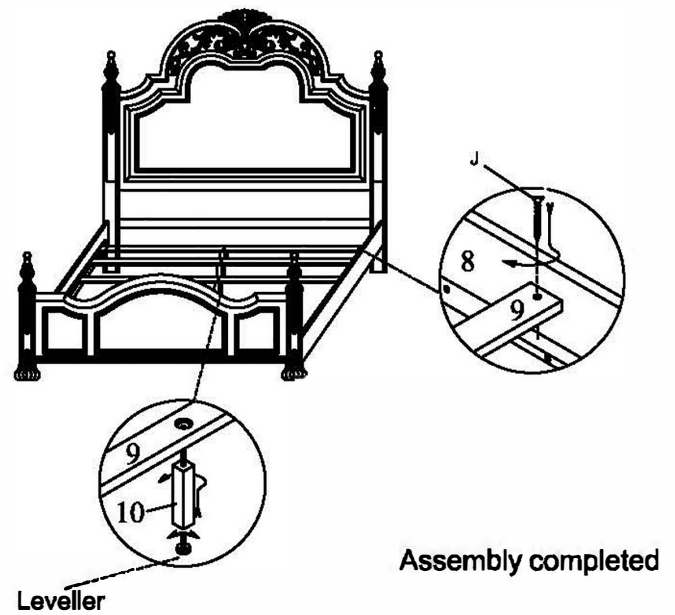

NOTE: Fasten the bolts after alignment for the bottom line of the footboard to the side rails.



- For items use on wooden floor hard surfaces or carpets. It is recommended to install protective pads under all legs and supports to avoid/prevent from damages/scratches and discoloration.
- Hardware may loosen over time. Periodically check to make sure all connections are tight. Re-tight if necessary.