

flox

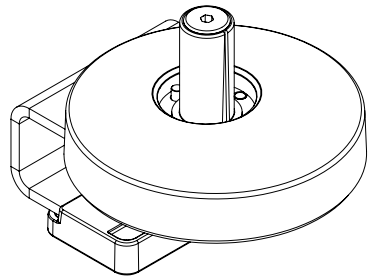

FLO X TOP MOUNT CLAMP

FLX/018/C07

PARTS INCLUDED

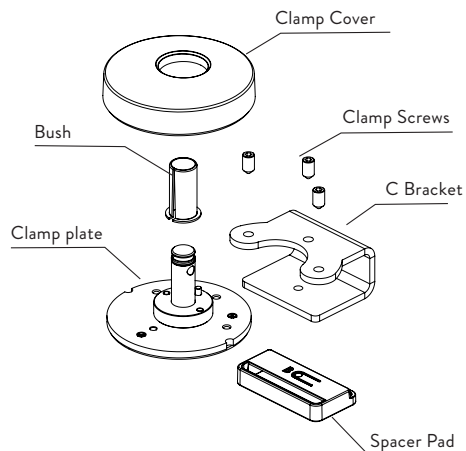

1 POSITION CLAMP PLATE ONTO WORK SURFACE

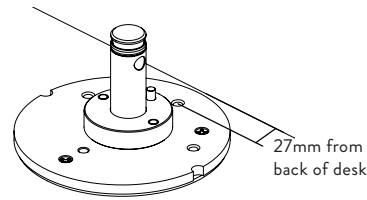

2 CONFIGURE FOR WORKSURFACE THICKNESS

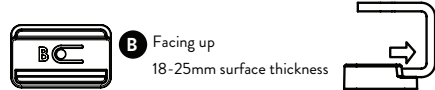
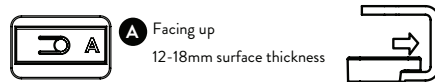
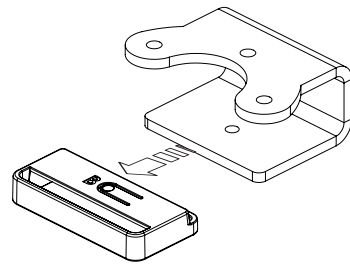

3 FIT C-BRACKET

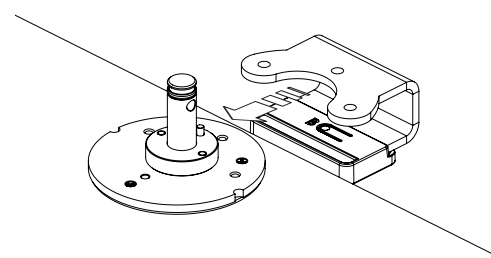

IMPORTANT NOTE
Ensure inside of bracket is flush against back of work surface

4 FIT CLAMP SCREWS

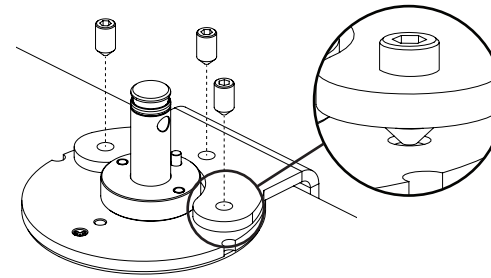

5 FULLY TIGHTEN SCREWS

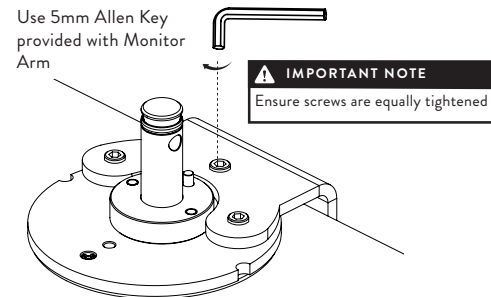

6 CONFIGURE 180° STOP (if required)

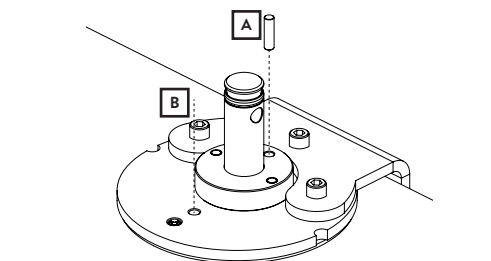
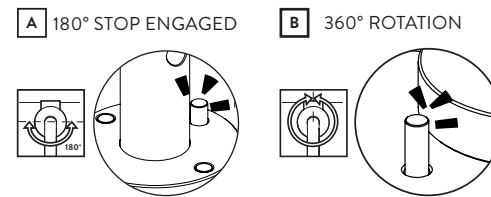

7 FIT CLAMP COVER AND BUSH

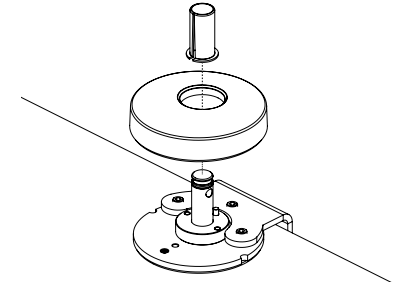

WARNING

- Do not use this product for any purpose other than that for which it was designed
- Ensure desk/worksurface is suitable to take the weight of the arm/s and monitors
- Supported weight must not exceed the maximum load per arm
- Take care when installing as fingers could become trapped

MAINTENANCE AND INSPECTION

- Ensure all screws are tightened and occasionally adjust if needed
- Ensure arm is pushed fully down onto the clamp before installing the monitor(s)
- Clean with a damp cloth, NO solvents

DISCLAIMERS

- The use of power tools, lever bars or excessive force during the installation, or re-configuration of the product will invalidate your guarantee
- Failure to observe the recommendations in the use, and configuration of these products may affect your guarantee
- As a part of Colebrook Bosson Saunders ongoing product improvement programme the design of products may change without prior notice and details may vary from those illustrated

PATENTS

Colebrook Bosson Saunders hold a number of patents and other intellectual property rights covering our products and processes. You can find patent information on our website at: www.colebrookbossonsaunders.com/patents

Please consider leaving these instructions with the product if further installation may be required by others

FLX-018-C07-INST-A-SEPT-2022