



OLYMPIA

1375.60LG/OiG

DESIGN

Rotisol's traditional rustic-style rotisserie, the OLYMPIA, is an attractive show-piece for any restaurant or kitchen and is used by chefs in Michelin's star restaurants around the world.

The naked flame from Rotisol's patented burners lick the cast iron hearth and porcelain wicks creating a spectacular visual that can be seen through the front and side glass doors.

Spits are driven by an elegant system of chains and pulleys, rotating at 2 ½ times per minute ensuring perfectly cooked, self-basting poultry, meat, vegetables and fish.

FEATURES

- Rotisol patented burners.
- 4 tempered glass doors.
- Protective roof included.
- Equipped with bottom drip tray with drainage tap.
- Pre-installed vertical spit system.
- Powerful halogen lamp.

FINISHES

Standard model in black enamel. A choice of other colours are available.



With chrome or brass trims.











1375.60LG

Black and brass finish



ACCESSORIES

A variety of accessories are available for the unit. Video of available [accessories](#) and video of [vertical spit system](#).

CUI13 Anti-cutting prongless spit. 	BP13 Chicken spit. 	BRC13 Basket spit. 
BS13 Sabre spit for ham / turkey. 	BRRO13 Roast-clamp spit. 	BA13 Lamb/suckling-pig spit. 
GCP13 Spare rib rack. 	GSV13 Raised rack for meat storage. 	PID13 Stainless steel tray to unspit. 

Front view
Rotisserie with roof
and base on casters

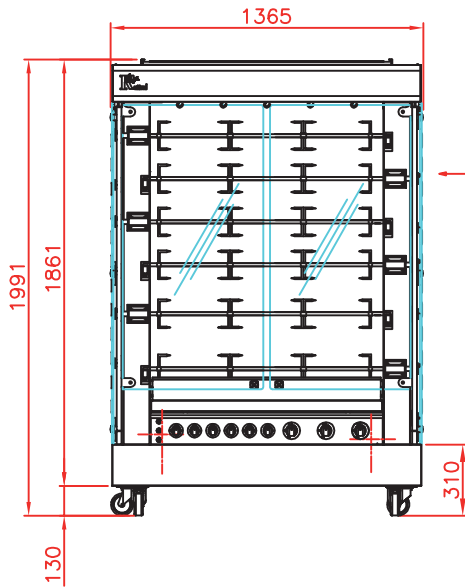

Side view
Rotisserie with roof
and base on casters

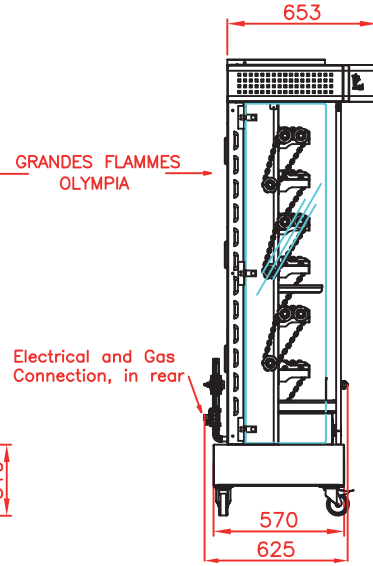

Top view
Rotisserie with roof
and base on casters

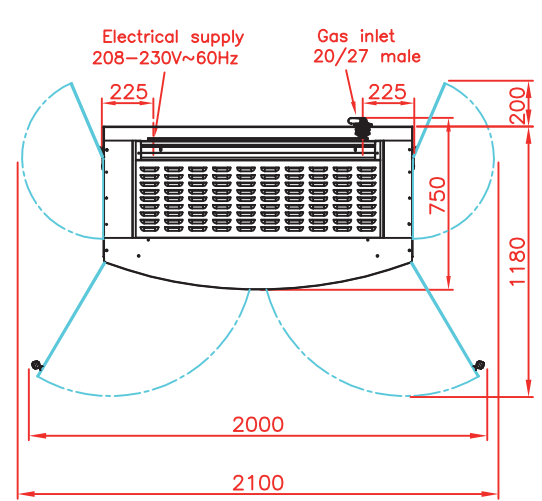

1375.60iG

Stainless steel finish



SPECIFICATIONS

Gas Power	Natural : 123000 BTU/h ; Propane : 112000 BTU/h.
Gas minimum pressure	Natural : 17,4 mbar. Propane : 27,4 mbar.
Gas connector	¾" male
Electricity	208-230 Volts 1 phase + neutral + earth
Capacity	30/36 poultries
Warranty	1 year parts and labor
Venting	Hood installed conformly with all local codes
Minimum clearance	2½" on the right, left and rear side
Shipping weight	415 kg

Revised : February 2017

CANADA DISTRIBUTOR

Rotisol S.A.S.

Zone industrielle La Trentaine, Avenue Gustave Eiffel
77507 Chelles cedex - FRANCE
bennell@rotisol.com - Tel : +33 1 64 21 80 00
www.rotisol.com

Celco Inc.

www.celco.ca

585 Secretariat Court, Mississauga, Ontario, L5S 2A5
(905) 364-5200 1-866-77CELCO (23526) info@celco.ca