



Chef
EXPRESS

SUMMARY

| | | |
|---|-------------------------|----|
| 1 | WARRANTY | 3 |
| 2 | SAFETY INSTRUCTIONS | 6 |
| 3 | INSTALLATION | 9 |
| 4 | CHEF EXPRESS TECHNOLOGY | 12 |
| 5 | OPERATION PRINCIPLES | 13 |
| 6 | RECIPES CREATION | 15 |
| 7 | OPERATION | 16 |
| 8 | CLEANING INSTRUCTIONS | 21 |
| 9 | CONCLUSION | 24 |

LETTER TO CUSTOMERS

Prática Inc. are proud to become part of your day-to-day lives with our products. By purchasing Prática's appliances, you will have a partner that always will be attentive to your needs and interested in keeping customers satisfied.

We are available to serve you at any time, whether it is to hear your ideas, criticisms, suggestions, or solve a problem.

Count on us!

Our Mission

Bring quality and productivity to the food preparation environment.

Our Commitment

- Always knowing and meeting the needs of our customers.
- Offering reliable, high-performance, and energy-efficient products.
- Always looking for improvements of processes, products and cost to offer more value to our customers every single day.
- Treat our customers with complete honesty and respect.
- Prática Inc. donates a portion of our profit to charitable causes.

1 WARRANTY TERM

1.1 Terms and detailing

- a) Our products have a legal warranty of three months and contractual warranty of nine months (one year in total) from purchase invoice issuance date and applies only to the first purchaser. If for any reason the purchase invoice cannot be found, the equipment manufacture date contained in the indicative label will be considered as the start date of enforceability of this warranty. The following will be covered under warranty.
- b) Regardless of the actual installation or use of the equipment, the warranty period is started per the date of issuance of the purchase invoice.
- c) For delivery and installation of the equipment, Prática will send, at no cost to the customer, an authorized technician to the site where the appliance will be installed (or the customer can call a technician of their choice, if preferable).
- d) If new visits are needed to complete the delivery/installation of the product due to the lack of adequate, electrical, or exhaust related conditions, the costs of such visits shall be the customer's responsibility.
- e) For the appliance's installation, the customer must provide all conditions required (water, light, gas, grounding and exhaust if needed) in the installation blueprint. The customer will also be responsible for transporting the equipment to the installation site.
- f) The warranty only covers manufacturing and component failures.
- g) The warranty will cover maintenance, adjustments or replacement of defective parts. It is the responsibility of the customer or technician to return the defective parts to Prática Inc. for analysis.
- h) Warranty service calls will not justify the extent of the warranty, returns or exchanges of the equipment, or any other type of claim.

1.2 Warranty Exclusions

- a) The customer should thoroughly inspect the equipment upon delivery and contact the carrier in case of shipping damage arising from transport. At the time of installation, the technician should find the equipment in its original packaging (fully preserved).
- b) Irregularities in building installation systems.
- c) Please use the Installation and Operation Manual that are included with the product.
- d) Failure to observe the installation details per the Installation and Operation Manual, such as: uneven floors, installing the oven next to equipment that exude fat, heat or solid particles, lack of air circulation, etc.
- e) Any damage and defects resulting from inappropriate cleaning that causes damages to the components will not be covered under warranty. For example, pouring water inside the electric panel, etc.
- f) Changes performed by unauthorized technicians in the original conditions of installation such as electrical distribution, installation location, etc.
- g) Use of aggressive or abrasive products that are unsuitable for cleaning which may tarnish, wear, scratch or damage accessories or equipment components.
- h) Damage and operational failures arising from unfiltered water with great calcium content or electrical supply with voltage oscillation or noise/interference in power line.
- i) Occurrences from electrical discharges arising from acts of nature or voltage peaks caused by generators or supply companies.
- j) Damage to the equipment or its accessories because of accidents, abuse, improper operation, improper handling or Installation as described by the Operation Manual included with this product.

- k) Repair attempts by unauthorized third parties or use of non-OEM parts and components, regardless of the damage or defects.
- l) Wear and tear components are excluded from the warranty such as lights, seals, belts, bearings, chains, tarps, glass, plastics, etc.

1.3 Notes and Recommendations

- a) The operator can use the Installation and Operation Manual as a guide.
- b) Make sure that the electric and exhaust systems are made and installed by a qualified company or technician.
- c) Before contacting technical assistance, check the manual for troubleshooting tips that can be solved without a technician.
- d) The wear and tear of the unit is not covered by warranty. To ensure productivity and increase the life of the product, it is essential to perform the daily cleaning and a preventive maintenance regularly.
- e) You can call our technical assistance to provide feedback, offer suggestions, or get assistance troubleshooting during normal business hours at: +1 214 299-7726.

EQUIPMENT IDENTIFICATION

(Fill in to make technical support calls easier)

| | | | |
|----------------|--|---------------|--|
| MODEL | | | |
| VOLTAGE | | SERIAL NUMBER | |
| RESELLER | | | |
| INVOICE NUMBER | | PURCHASE DATE | |

2 SAFETY INSTRUCTIONS

- Read the manual carefully before installing the appliance.
When carrying out the daily cleaning, please use personal protective
- equipment such as protective gloves, apron, mask and goggles.



Protective Gloves



Protective Mask



Apron



Goggles

- The appliance **MUST** be grounded.
- The oven must have a dedicated circuit breaker.
- Do not allow the power cord or the plug to get wet.
- Keep the power cord away from heated surfaces.
- If the power cord is damaged, it must be immediately replaced by an authorized technician to avoid shock hazard.
- Only qualified personnel should open the equipment panel.
- Do not use plastic utensils.
- Do not use the Microwave function without food as it can damage the appliance.
- Do not operate the equipment with the door open due to microwave energy exposure.
- Do not allow food residue or other debris to accumulate on the surface of the door and hinge to avoid damaging the appliance.
- Do not use the appliance if it is damaged. The oven's door should always close properly.
- Fully sealed packages should not be heated in the oven as they can explode.
- Use this appliance only for the functions described in this manual.
- Do not allow children to use or operate this appliance.
- Do not cover or block any air vents on unit.
- Do not use the appliance outdoors or without coverage.
- Do not use this product near water such as near the kitchen sink, in a wet basement, or near a swimming pool.
- Do not use a water jet for cleaning. Please see cleaning instructions for proper cleaning.

- Remove all contents located inside the oven cavity.
- If the product catches fire inside the cook cavity, close the door immediately and turn the unit off or unplug it. The power can also be turned off at the circuit breaker.
- Do not use the cavity of the appliance for storage.
- Always wear thermal gloves or use holders or tongs to remove the food from inside the equipment to avoid burns.
- Liquids heated in the microwave can cause a delayed eruption due to thermal shock.
- The appliance is not intended for use by persons (including children) with reduced physical, sensory or mental capabilities, or that have not been properly trained to operate the unit.
- The minimum height of free space above the microwave should be of 5.9in (150mm).
- Only use utensils suitable for use in microwave ovens.
- When heating food in microwave safe container, check the oven frequently due to the possibility of ignition.
- The oven should be cleaned daily and any food remains should be removed.
- Failure to maintain the oven in a clean condition could lead to deterioration of the surface that could adversely affect the life of the appliance and possibly result in the loss of warranty.
- **CAUTION:** To avoid burns, do not use containers with liquids or kitchen products that become liquids by heating up to boiling point. This marking must be mounted after installation at 5.25in (1.6m) above floor level.



PRECAUTIONS TO AVOID POSSIBLE EXPOSURE TO EXCESSIVE MICROWAVE ENERGY

- Do not attempt to operate this oven with the door open since open-door operation can result in harmful exposure to microwave energy. It is important not to defeat or tamper with the safety interlocks.
- Do not place any object between the oven front face and the door or allow soil or cleaner residue to accumulate on sealing surfaces.
- Do not operate the oven if it is damaged. It is particularly important that the oven door close properly and that there is no damage to the:
 - a) Door (bent),
 - b) Hinges and latches (broken or loosened),
 - c) Door seals and sealing surfaces,
- The oven should not be adjusted or repaired by anyone except properly qualified service personnel.

3 INSTALLATION

The installation of our products must be done with care to avoid problems or damage to the equipment and guarantee its optimal performance. This appliance must be installed by an authorized technician.

3.1 Dimensions

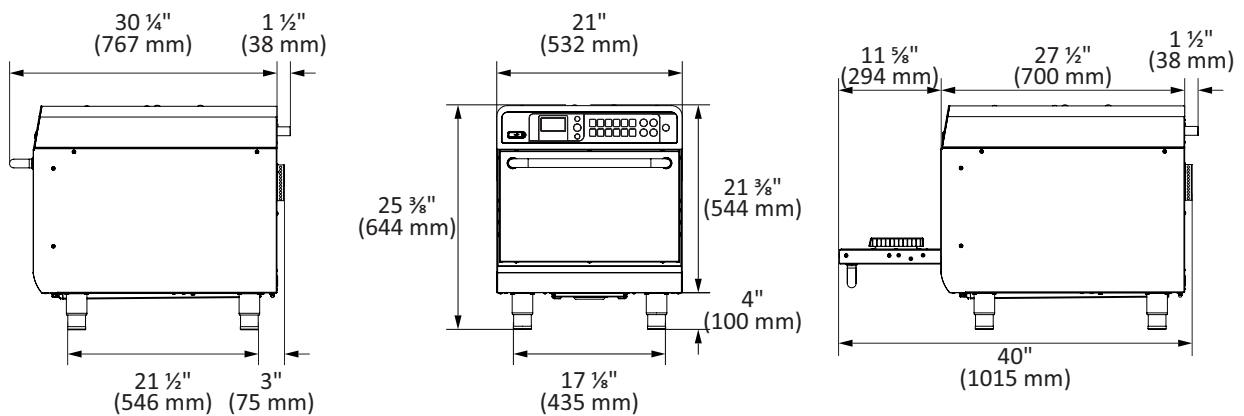

| Chamber Dimension | |
|-------------------|------------------|
| Capacity | 21 Litres |
| Height | 5 3/4" - 146 mm |
| Width | 15 1/2" - 394 mm |
| Depth | 14 1/4" - 362 mm |

3.2 General Instructions

- The oven must be installed on a surface or counter that supports its weight of approximately 194lb (88 Kg).
- Do not block the air inlets or outlets of the unit.
- The oven must not be positioned near stoves, deep fryers, hot plates and other equipment that releases fat, fumes and heat. The ventilation, electrical panel and motor vents must be far from these heat sources to prevent damage to the electrical system of the appliance.
- The oven must be installed in a leveled and well ventilated area.
- The installation of the equipment in a non-suitable place can result in the loss of warranty.

3.3 Electric Power

Make sure that the electrical characteristics of building electric network follow the technical specifications of the oven which can be found on the identification plate located on the back panel and in the electrical table below.

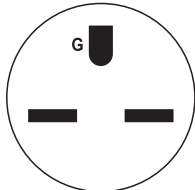
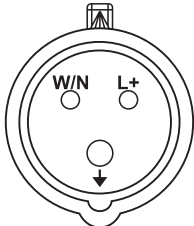
| USA - CANADA | | EUROPA | |
|--|-----------|---|--------------------|
| Voltage | 208 V | Voltage | 230 V |
| Phases | Single | Phases | Single |
| Frequency | 60 Hz | Frequency | 50 Hz |
| Power | 5.7 kW | Power | 7.2 kW |
| Circuit Breaker | 30 A | Circuit Breaker | 32 A |
| Consumption | 4 kWh | Consumption | 5 kWh |
| Cable | 3x10AWG | Cable | 3x4mm ² |
| Socket | NEMA 6-30 | Socket | 32A(2P+T) |
|  <p>NEMA 6-30</p> | |  <p>32A(2P+T)</p> | |

Use a dedicated circuit breaker for the oven, that must be located at least 6ft (1.8 m) away from the right sides of the oven.

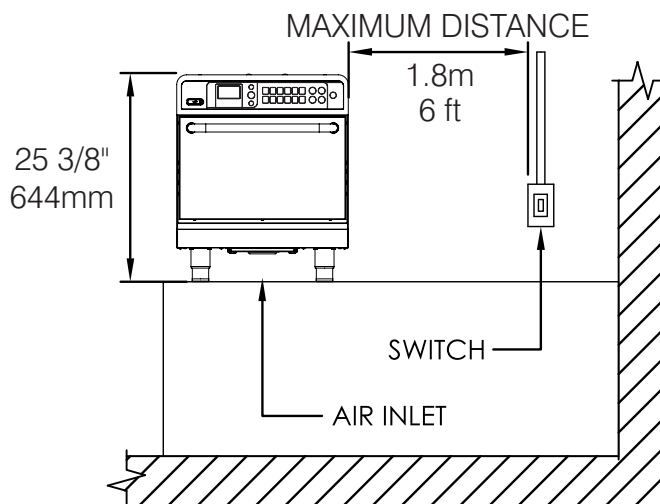

- Properly size the circuit breaker and network cables. The oven requires the use of 30A circuit breaker and a 3 x10 AWG power cord.
- The oven **MUST** be properly grounded. In the event of damage due to improper grounding to third parties and/or to the equipment, the will be held responsible and will characterized as negligence due to the non-compliance with the standards.
- There is an equipotential point on the rear panel of the oven.



4 CHEF EXPRESS TECHNOLOGY

The *Chef Express* oven uses a combination of heating for high-speed forced air convection and microwave energy to heat forced food more quickly than the conventional methods.

The figure below illustrates the steps involving the technology:

- a) Internal heating elements transfer thermal energy to the circulating air.
- b) The blower motor circulates air at high speed and envelops the food.
- c) The circulating air goes through the catalyst where the grease-laden vapors are broken down.
- d) The bottom heater helps the heat transfer within the chamber.
- e) At the same time, Magnetrons generate energy via microwave that evenly heats the food water molecules.

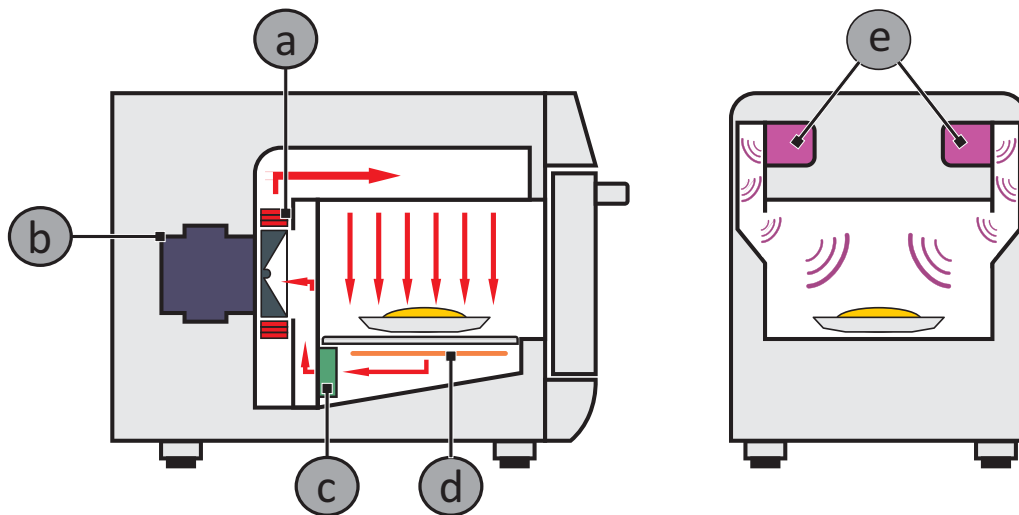

5 OPERATION PRINCIPLES

Microwaves are a type of radiant energy. As well as radio waves, visible light and infrared, the microwaves are part of the electromagnetic spectrum, i.e., it is a form of electromagnetic radiation. They are classified as non-ionizing radiation, because unlike x-rays and Alpha, Beta and Gamma rays, its effects are strictly thermal and therefore do not alter the molecular structure of the item that is being irradiated.

The basic principle of microwaves is to cook by molecular vibration. They penetrate the food surface in a depth that ranges from two to seven centimeters, heating the molecules of water, fat and sugar by making them vibrate. The heat is transmitted to the interior of the food by thermal conduction, demystifying the idea that the microwaves cook food from the inside out.

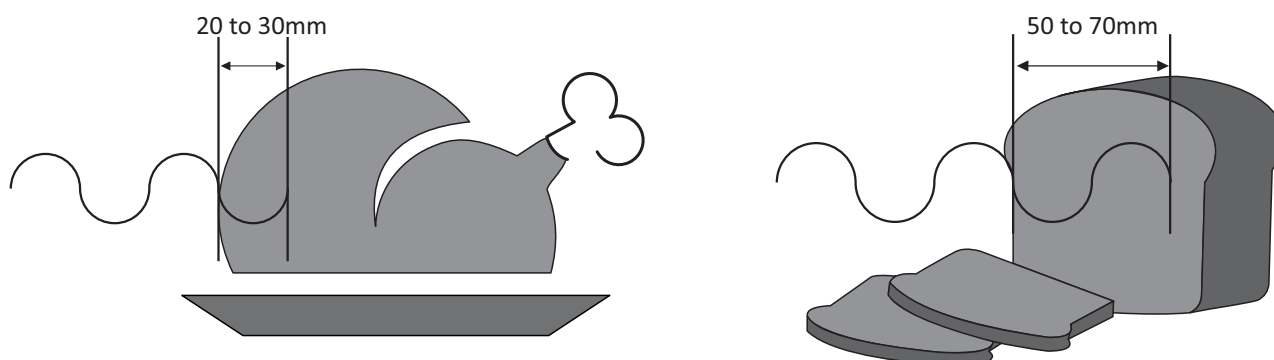

The Chef Express works through the association between microwaves and hot air directed towards the food. The variables in the operation consist of:

- a) Operation time.
- b) Chamber temperature.
- c) Microwaves power.
- d) Air speed.

Each operation recipe can be programmed with up to six steps and each of them can have the variables mentioned above.

Temperatures: The preparation times are short and so are the steps. The temperature variation between steps will not be observed by the unit. Normally the temperature used is the same temperature as the cook cavity set point.

Microwaves: The microwave is adjustable between 0% and 100% for each 30 second fraction. For example, the microwaves in a one-minute recipe with microwave programmed at 50% will run for 15 and stop for 15 seconds. Then they will energize for another 15 seconds and stop for the remaining 15 seconds. In 1 minute, they will act for a total of 30 seconds. The microwaves heat the food internally and do not require a specific mean to propagate. Microwaves are reflected by metals but will penetrate glass, plastics, and ceramics. The microwaves penetrate food and become attracted to sugar, fat and water molecules.

CHARACTERISTICS

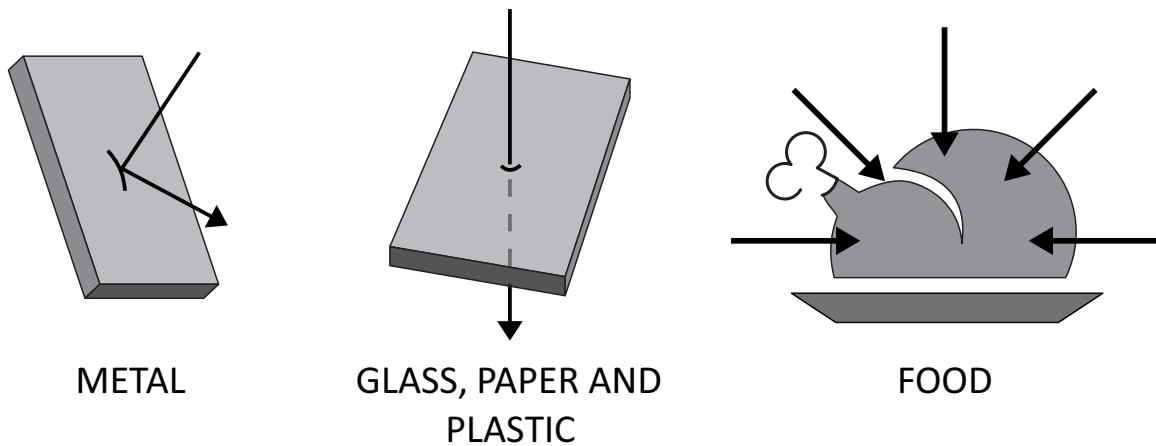

The use of plastic or paper containers is forbidden because they will burn inside the oven because of the heat.

Operation Time: The food heated by microwaves occur from the outside in and the penetration level will vary depending on the type of food. Therefore, you should relate the preparation time to the food composition, the quantity of food processed, as well as its density and thickness. The larger the food amount (quantity or density), the greater the time or percentage will be needed for the microwave to take effect.

Hot Air Speed: The hot air can be adjusted between 10% and 100% speed. The hot air is controlled by a blower motor which will envelope the food.

- a) The higher the air speed, the more likely it will be to burn the product on the outside.
- b) The higher the air speed, the more it will affect the texture and crispness of the product.

6 RECIPES CREATION

When creating a recipe, all the variables mentioned earlier should be considered. The microwaves and the air speed are the critical factors for a successful preparation.

To get faster results in the recipe creation, we suggest beginning programming at 1/10 of the total time of preparation used in a conventional process.

The effect of microwaves is more efficient at the beginning of the processes. For frozen products, create a recipe with two or three steps so the food will thaw at the beginning and the desired crispness and product presentation are achieved toward the end of the process.

Later, combine the air speed variations to reach the desired crispness and color. Remember, the air also transmits heat to the food so keep that in mind when setting blower percentage. The food's weight, size, and shape are critical when setting the total cook time.

The following information is critical when creating a new recipe.

- a) The initial temperature of the product will change the desired results if not considered (e.g.; frozen, cold, or room temperature).
- b) The size and/or weight variation of the portion of product will also play a crucial role in determining the correct settings.
- c) Only use containers approved for a microwave oven to prevent any damage and that the product gets properly cooked.

7 OPERATION

7.1- Preheating

a) When you turn the oven on - the following message will appear:



b) When 525°F is reached, a message will appear in the display showing that there will be 5 minutes left to the end of preheating process.

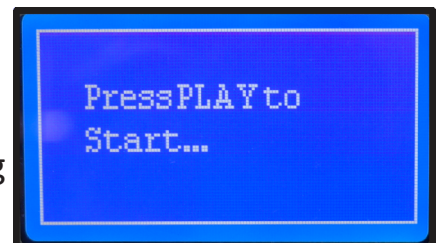

7.2- Play recipes

a) Switch on the oven and wait until the following message appears.





b) Press  to display the group's screen;



c) To select a group, use the keys  /  or type the number of the group.



d) To start a recipe, use the arrows  /  or type the recipe's number using the alphanumeric keyboard.

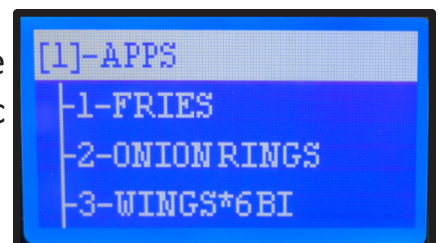

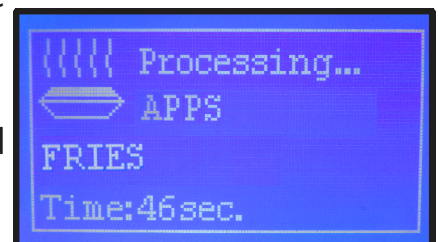

e) During the process, the display will show the cooking time, group and the recipe's name.



f) At the end of the cooking, the alarm will sound and the message «Ready» will appear.

g) The «Cook More» function will be enable to use after the end of preparation, with the door opened.

Close the door and press:

-  More 10 seconds
-  More 20 seconds
-  More 30 seconds

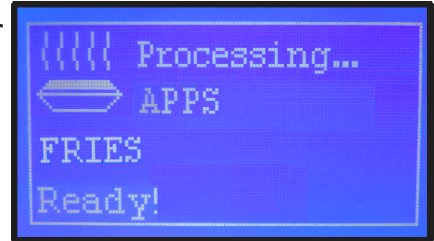

h) This option will be available for 10 seconds after the door is closed.



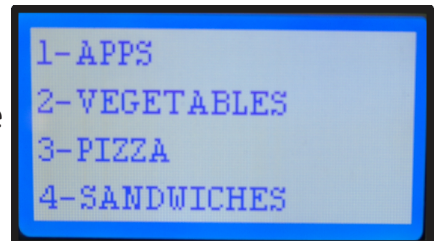

7.3- Creating and editing groups.

a) While in the group's menu, press  to allow the edition function, as shown:



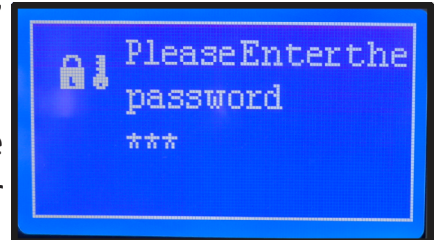



b) With arrows  /  or alphanumeric panel, select which group edit.



c) Enter the password (123 - standard) using the alphanumeric keyboard and press  to enter the edition mode.

d) Press  to edit group's name or create a new group.

-  to erase or backspace.
-  to 0(zero) or '_' and '*' symbols.
-  up to  to numbers and letters.

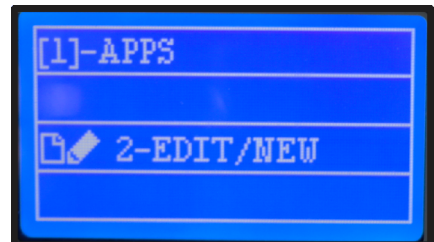

e) After changes, press  to save.

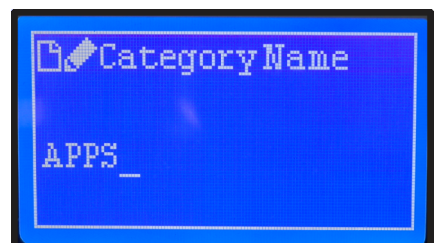



7.4- Creating, editing and deleting recipes.



a) While in the recipe's menu, press  to allow the edition function.

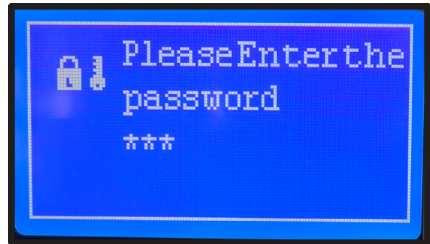





b) With arrows  /  or alphanumeric panel, select which recipe edit.

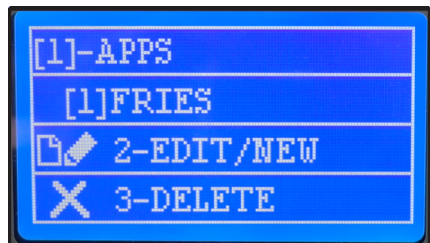

c) Enter the password (123 - standard) using the alphanumeric keyboard and press  to enter the edition mode.

d) Press  to edit recipe's name or create a new recipe or press  to delete the recipe.



-  to erase or backspace.
-  to 0(zero) or '_' and '*' symbols.
-  up to  to numbers and letters.



e) After changes, press  to save and edit steps. Each recipe supports up to 6 steps. Use the alphanumeric keypad to select the step to be added or edited.

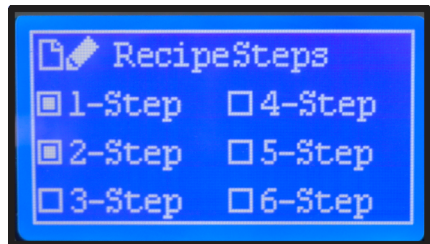

f) The following parameter settings will appear: time, chamber temperature, microwave percentage and hot air speed.





g) Use the arrows  /  to navigate through and choose the parameter. Press  to edit.







h) Set the parameter value with the alphanumeric keypad and press  to confirm and save.



i) To **DELETE** a step, set the time value to zero.

j) Press  to save, and  to go back.

7.5- Manual mode.

- a) While in the recipe's menu, press  to enter the manual mode.
- b) The following will appear: time, chamber temperature, microwaves power and hot air speed.
- c) Use the arrows  /  to navigate through and choose the parameter, press  to select and edit.
- d) Set the parameter value with the alphanumeric keypad.
- e) Press  to confirm and  to start.
- f) During the process, the display will show only the cooking time.
- g) At the end of the cooking, the alarm will sound and the message «Ready» will appear.

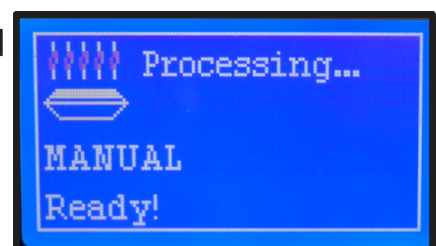
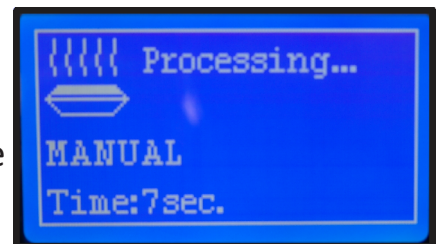



7.6- Importing and exporting function.

- a) Remove the cover of the USB port shower below and insert the Flash Drive.



a) Press  . Using the alphanumeric keyboard, press 2 or 3 Export or Import recipes:

 Export Recipes - The recipes are copied from the oven to the Flash Drive.

 Import Recipes - The recipes are copied from the Flash Drive to the oven.

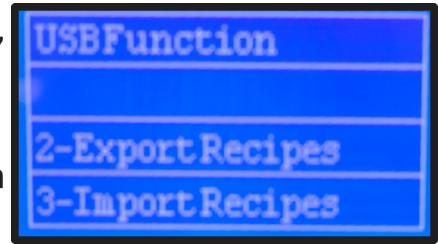

b) Using the alphanumeric keyboard, press  to export/import all recipes from the oven to Flash Drive.



c) Wait until the message: 'Operation Completed'.



IMPORTANT

When the **IMPORT** command is executed, all the oven's recipes are replaced

When the **EXPORT** command is executed, all the Flash Drive's recipes are replaced.

7.7 Cooling the oven.



a) Press  and open the equipment's door. The display will indicate that cooling is in progress. Wait until the desire temperature is reached. The cooling function can be torner on at any time.



ATTENTION

During the cooling process, tha fan remais on even with the door open.

7.8- Temperature inspection

- a) While in the recipe's menu, press  to inspect the temperature mode.
- b) The following settings will appear: Chamber temperature and inferior resistors temperature.
- c) Press  to go back to the recipe's screen.

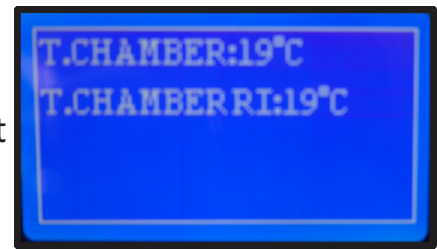

8 CLEANING INSTRUCTIONS

8.1 Daily cleaning

The Kay Oven Cleaner is ready for use and efficient for the internal and external cleaning of the *Chef Express* oven.



Kay Oven Cleaner



Cloth



Anti-abrasive sponge

The product is safe for handling, non-corrosive, being approved and recommended by Prática.

Procedure





Leave the product applied in place for 5 to 10 minutes

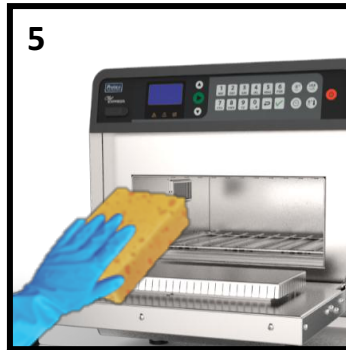

Rub using the anti-abrasive sponge

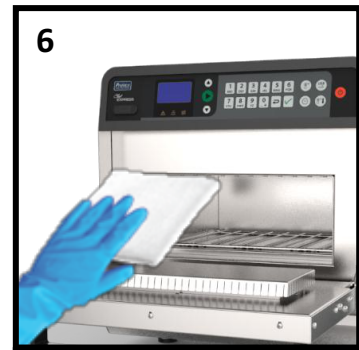

Wipe the oven with a wet cloth

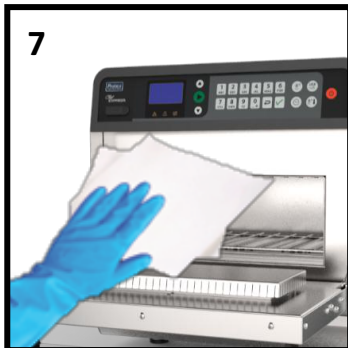

Dry it with paper towels

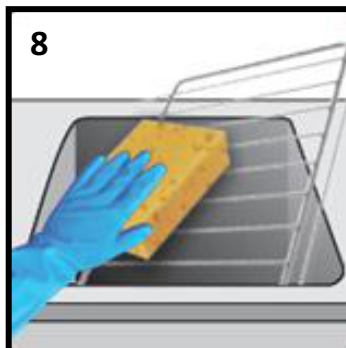

Rub the grids and holders

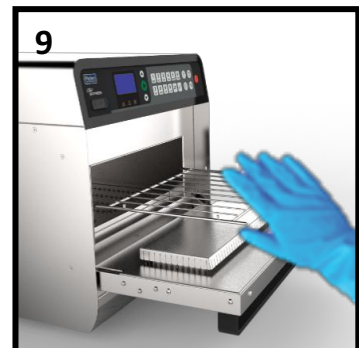

Reassemble the oven

ECOLAB®

NOTE

The Kay Oven Cleaner can be purchased through Ecolab distributors.

8.2 Cleaning the air filter

To access the catalytic converter, remove the baking stone, the rack, and the bottom jet-plate from the oven. Then remove the catalyst through a vertical movement upwards, as shown in the following image.

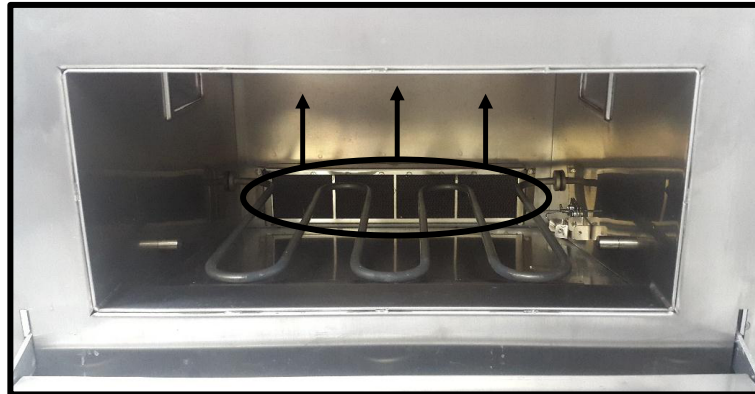

Soak the catalytic converter in warm water with neutral detergent. After 15 minutes, rinse it thoroughly and put the catalytic converter back in the oven.

8.3 Cleaning the stone.

The stone should be cleaned with a cloth, sponge, a towel.

Note: DO NOT immerse the stone in water and don't use water to clean the stone. If the stone is wet, let it dry completely before using it again.

9 CONCLUSION

We emphasize characteristics necessary for the professionals that operate these equipments: **Responsibility, Initiative and Creativity.**

Responsibility appears to be a tool that incorporates innovation and technology, and that is an investment that should give the return compatible with the needs of the institution where both man and machine will work together. Ovens must be operated with caution and care to provide best results.

Initiative is necessary when an opportunity is given to operate such a great tool as a Prática oven. The operator can extract optimal equipment performance and adapt to the oven.

Creativity must be possessed by the professionals who are willing to master the oven as a tool. Nothing is better than human creativity and those who have it are better prepared to develop their own skills and recipes. se who have it are better prepared to develop their own skills and recipes.



CELCO INC. - CANADA

585-Secretariat Court
Mississauga ON L5S 2A5

Phone: +1 866 772-3526

info@celco.ca

www.celco.ca

CODE

760307

CHEF EXPRESS - CPCE536
INSTALLATION AND OPERATIONAL MANUAL
JULY 2017 - REVISION 03