



ECONOMY

REFRIGERATOR-FREEZER

Instruction Manual

ER1A-FS

ER2A-FS

EF1A-FS

EF2A-FS

WARNING

Only qualified service technicians should install and service the appliance. To obtain the name and phone number of your local Certified Service Representative, visit www.economyseries.com. No installation or service should be undertaken until the technician has thoroughly read this Instruction Manual. Likewise, the owner/manager should not proceed to operate the appliance until the installer has instructed them on its proper operation. Failure to install, operate, and maintain the appliance in accordance with this manual may adversely affect safety, performance, component life, and warranty coverage. Proper installation is the responsibility of the installer. Product failure or property damage due to improper installation is not covered under warranty.

This manual is provided primarily to assist qualified service technicians in the installation, maintenance, and service of the appliance.

Should the reader have any questions or concerns which have not been satisfactorily addressed, please call, send an e-mail message, or write to the Technical Support Department for assistance.

Phone: (800) 227-3172

E-mail: techsupport@economyseries.com

ECONOMY SERIES

618 Highway 74 South

Peachtree City, GA 30269

Attn: Technical Support Department

Web Site: www.economyseries.com

NOTE: To expedite assistance, all correspondence/communication **MUST** include the following information:

- Model Number _____
- Serial Number _____
- Complete and detailed explanation of the problem.

TABLE OF CONTENTS

Important Safety Information.....	5
Know your Equipment.....	9
Check for Shipping Damage.....	10
Handling the Cabinet.....	10
Location.....	11
Remove the Crate and Skid	12
Level the Cabinet.....	12
Electrical Installation	13
Installing the Shelves.....	14
Start up the Cabinet	14
Door Reversal	15
Controls and Adjustments.....	20
Cleaning and Preventive Maintenance.....	22
Disposal	23



ER1A-FS, EF1A-FS



ER2A-FS, EF2A-FS

Important Safety Information

Important Safety Information

Throughout this manual, notices appear to bring your attention to situations which could result in death, serious injury, damage to the appliance, or damage to property.

⚠ DANGER	Indicates a hazardous situation that, if not avoided, will result in death or serious injury.
⚠ WARNING	Indicates a hazardous situation that, if not avoided, could result in death or serious injury.
NOTICE	Indicates a situation that, if not avoided, could result in damage to the appliance or property.
IMPORTANT	Indicates important information about the use and care of the appliance.

⚠ DANGER
<p><u>Risk of Fire or Explosion</u></p> <p><u>Flammable Refrigerant Used</u></p> <ul style="list-style-type: none"> • Follow handling instructions carefully in compliance with U.S. government regulations. • Do not use mechanical devices to defrost. • Do not puncture refrigerant tubing. Risk of fire or explosion due to puncture of refrigerant tubing; follow handling instructions carefully. • Component parts shall be replaced with like components. • Servicing shall be done by factory authorized service personnel to minimize the risk of possible ignition due to incorrect parts or improper service. • Consult instruction manual / service manual before attempting to install or service this product. All safety precautions must be followed. • Dispose of properly in accordance with federal or local regulations. • Do not place any potential ignition sources in or near the appliance.

<p><u>Risque De Feu Ou D'Explosion</u></p> <p><u>Le Frigorigène Est Inflammable</u></p> <ul style="list-style-type: none"> • Suivre attentivement les instructions de manipulation conformément à la réglementation gouvernementale. • Ne pas utiliser d'appareils mécaniques pour dégivrer le réfrigérateur. • Ne pas perforez la tubulure contenant le frigorigène. Risque de feu ou d'explosion si la tubulure contenant le frigorigène est perforée; suivre les instructions de manutention avec soin. • Les pièces des composants doivent être remplacées par des pièces et accessoires équivalents. • L'entretien doit être effectué par le personnel de service autorisé par le fabricant afin de minimiser les risques d'inflammation attribuables à l'installation d'une pièce inadéquate ou à la mauvaise exécution du service. • Consulter le manuel du propriétaire/ guide de réparation avant de tenter une réparation. Toutes les mesures de sécurité doivent être respectées. • Éliminer conformément aux règlements fédéraux ou locaux. • Ne placez aucune source d'inflammation potentielle dans ou près de l'appareil.
--

WARNING

This appliance should be destined only to the use for which it has been expressly conceived. Any other use should be considered improper and therefore dangerous. The manufacturer cannot be held responsible for injury or damage resulting from improper, incorrect, and unreasonable use. Failure to install, operate, and maintain the appliance in accordance with this manual will adversely affect safety, performance, component life, and warranty coverage.

To reduce the risk of death, electric shock, serious injury, or fire, follow basic precautions including the following:

- Only qualified service technicians should install and service this appliance.
- Wear appropriate personal protective equipment (PPE) when servicing the appliance.
- The appliance must be installed in accordance with applicable national, state, and local codes and regulations.
- Appliance is heavy. Use care when lifting or positioning. Work in pairs when needed to prevent injury or damage.
- The appliance requires an independent power supply of proper capacity. See the nameplate for electrical specifications. Failure to use an independent power supply of proper capacity can result in a tripped breaker, blown fuse, or damage to existing wiring. This could lead to heat generation or fire.
- To reduce the risk of electric shock, do not touch the plug with damp hands.
- Unplug the appliance from the electrical outlet.
- **THE APPLIANCE MUST BE GROUNDED:** The appliance is equipped with a NEMA 5-15 three-prong grounding plug (L1) to reduce the risk of potential shock hazards. It must be plugged into a properly grounded, independent 3-prong wall outlet. If the outlet is a 2-prong outlet, it is your personal responsibility to have a qualified electrician replace it with a properly grounded, independent 3-prong wall outlet. Do not remove the ground prong from the plug and do not use an adapter plug. Failure to follow these instructions may result in death, electric shock, or fire.
- The GREEN ground wire in the factory-installed power cord is connected to the appliance. If it becomes necessary to remove or replace the power cord, be sure to connect the power cord's ground wire.
- Do not use an extension cord.
- Do not use an appliance with a damaged power cord. The power cord should not be altered, jerked, bundled, weighed down, pinched, or tangled. Such actions could result in electric shock or fire. To unplug the appliance, be sure to pull the plug, not the cord, and do not jerk the cord.
- Do not splash, pour, or spray water directly onto or into the appliance. This might cause short circuit, electric shock, corrosion, or failure.
- Do not make any alterations to the appliance. Alterations could result in electric shock, injury, fire, or damage to the appliance.

WARNING, continued

- This appliance is not intended for use by persons (including children) with reduced physical, sensory, or mental capabilities, or lack of experience and knowledge, unless they have been given supervision or instruction concerning use of the appliance by a person responsible for their safety.
- Children should be properly supervised around this appliance.
- Do not climb, stand, or hang on the appliance or door or allow children or animals to do so. Do not climb into the appliance or allow children or animals to do so. Death or serious injury could occur or the appliance could be damaged.
- Be careful not to pinch fingers when opening and closing the doors. Be careful when opening and closing the doors when children are in the area.
- Open and close the doors with care. Doors opened too quickly or forcefully may cause injury or damage to the appliance or surrounding equipment.
- Do not use combustible spray or place volatile or flammable substances in or near the appliance. They might catch fire.
- Keep the area around the appliance clean. Dirt, dust, or insects in the appliance could cause harm to individuals or damage to the equipment.
- Do not throw anything onto the shelves or load any single shelf with more than 100 lb. (45.36 kg) of product. They might fall off and cause injury.
- Do not place anything on top of the appliance. Foreign objects or moisture could enter the appliance and result in electric shock or fire.
- This appliance is designed only for storage and/or display of packaged or bottled products. Employ sanitary methods. Use for any other purposes (for example, storage of chemicals or medical supplies such as vaccine and serum) could cause deterioration of stored items.
- Do not block the cabinet air inlet or outlet, otherwise cooling performance may be reduced.
- Do not tightly pack the cabinet. Allow some space between items to ensure good air flow. Also allow space between items and interior surfaces.
- Do not place any product on the floor of the cabinet. All product must be placed on properly installed shelves.
- Do not put warm or hot products in the cabinet. Let them cool first, or they will raise the cabinet temperature and could deteriorate other foods in the cabinet or overload the appliance.
- Do not store items near the air outlet. They might freeze up and crack or break causing a risk of injury or contamination of other food.
- This unit must be installed and located appropriately, following the installation instructions before its use.
- Do not allow children to climb, step or hang onto the shelves inside the appliance. Death or serious injury could occur or the appliance could be damaged.
- Do not touch the cold surfaces of the appliance with wet or moist hands. Skin can stick to these cold surfaces.

⚠ WARNING, continued

- Do not store gasoline or other flammable liquids or gases, near this or other electrical equipment.
- Keep your fingers away from grills; the spaces between doors and cabinet are small, so be careful when closing doors when children are around.
- Unplug the cooler before cleaning or performing any repair.

NOTICE

- Protect the floor when moving the appliance to prevent damage to the floor.
- Keep ventilation openings, in the appliance enclosure or in the built-in structure, clear of obstruction. Do not place anything on top of the appliance. Blockage of airflow could negatively affect performance and damage the appliance.
- To prevent deformation or cracks, do not spray insecticide onto the plastic parts or let them come into contact with oil.
- To avoid damage to the gasket, use only the door handle when opening and closing.

GENERAL SAFETY

- Avoid prolonged exposure of the appliance to direct sunlight.
- Only genuine spare parts should be used to service this freezer.



Know your Equipment

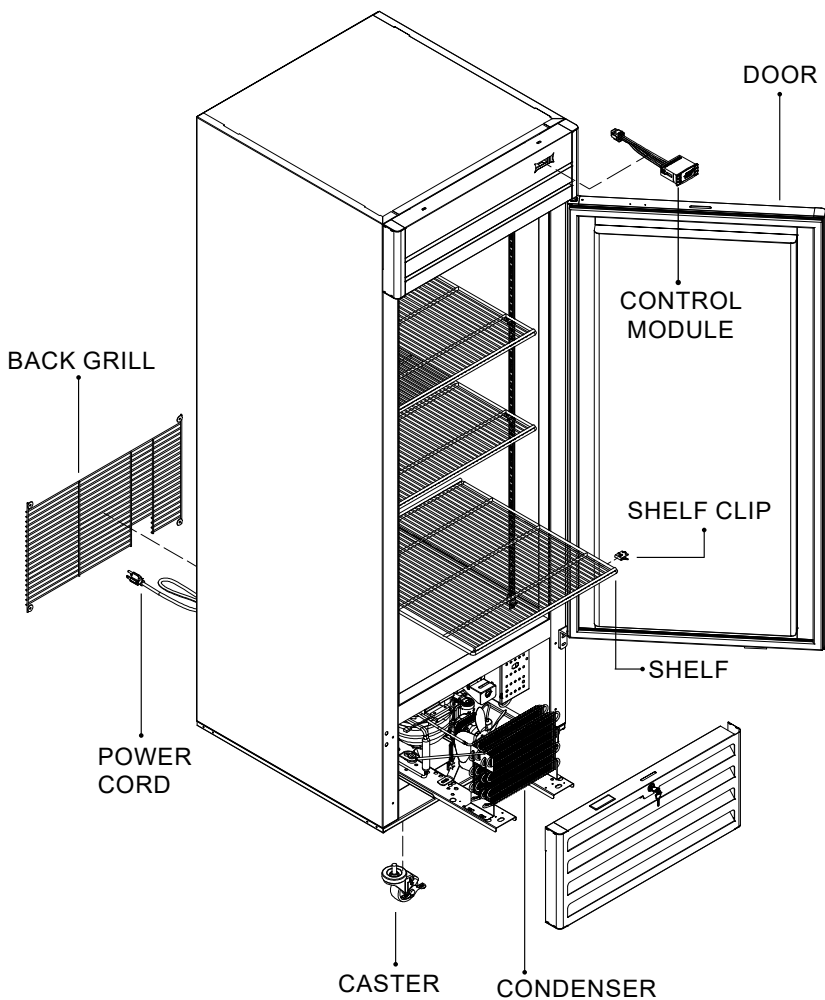

Check for Shipping Damage

Prior to leaving the factory, each cabinet is thoroughly inspected and performance tested to assure proper operating temperatures.

Check the crate thoroughly for signs of shipping damage. If external damage exists, internal damage is also probable. Uncrating should be done while the carrier's representative is present. Otherwise, the equipment should be uncrated as soon as possible, preferably within five (5) days.

The manufacturer is not responsible for in-transit damage and the consignee must file any required damage claims directly with the carrier. If the damage is severe and obvious, write a brief description of the evidence on the carrier's delivery receipt, and above the carrier representative's signature. Call the distributor or dealer immediately, indicating that the cabinet was damaged.

If no obvious crate damage is present, within two hours of receiving the cabinet from the carrier, remove the packaging to inspect for concealed damage.

1. If concealed damage is found, call the carrier immediately, **save all crating materials**, and file the necessary freight claim with the carrier.

Check for accessories: Check that the shelves are inside the unit, including the four clips or supports for each shelf.

Installation instructions

WARNING

- This appliance must be installed in accordance with all applicable national, state, and local regulations.
- Appliance is heavy. Use care when lifting or positioning. Work in pairs when needed to prevent injury or damage.
- Do not tilt the appliance more than 45°.

Handling the Cabinet

1. Always move the unit in an upright position. Do not set it on its side or upside down as you may damage the cabinet and spill the compressor oil.
2. If lifting the unit, hold it from its base. It is recommended to use a dolly.
3. Do not let the unit fall abruptly.

Location

⚠ WARNING

- This appliance is not intended for outdoor use.

1. Place the cabinet on a surface solid enough to prevent vibration and strong enough to support the combined weight of the cabinet and the product load. Quick guideline: Estimate 35 pounds per cubic foot of storage space.
2. Cabinets should never be placed in front of windows or glass doors where sunlight will be in direct contact with the units. If a cabinet is located near a window or glass door, provide an adequate shade to block the sun's rays.
3. Ambient temperature must be between 45°F (7°C) and 90°F (32°C). Low ambient temperatures below 45°F (7°C) are as harmful as high ambient temperatures. Extreme temperatures will definitely affect the performance of the cabinet.
4. Failure to properly level the cabinet could hinder proper drainage and door operation. Casters are provided with the cabinets.
5. Clearance: Leave a space of at least 8" between the back of the cabinet and the wall to provide adequate air circulation of the unit compartment.



Remove the Crate and Skid

1. Remove the external packaging (corrugated board and plastic wrapping). Check for concealed damage. If any damage is identified, immediately forward a complaint to the transportation company.
2. Move the cooler to its final location, before removing the skid.
3. Using a screwdriver remove the screws that attaches the skid to the appliance.



Level the Cabinet

To install casters:

Castors are supplied with the equipment. Only use genuine castors or the base of the cooler might suffer damages. When installing the castors it is important to hand tighten securely against the base rail reinforcement assembly (see image). The top edge of the caster must make firm contact with the reinforcement assembly.

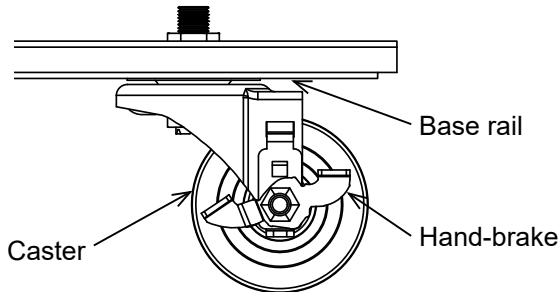

NOTE:

Castors with hand-brakes must be placed in FRONT of the unit.

Electrical Installation

Electrical Connection

WARNING

- Electrical connection must meet national, state, and local electrical code requirements. Failure to meet these code requirements could result in death, electric shock, serious injury, fire, or severe damage to equipment.
 - This appliance requires an independent power supply of proper capacity. See the nameplate for electrical specifications. Failure to use an independent power supply of proper capacity can result in a tripped breaker, blown fuse, damage to existing wiring, or component failure. This could lead to heat generation or fire.
 - **THIS APPLIANCE MUST BE GROUNDED:** This appliance is equipped with a NEMA 5-15 three-prong grounding plug (⚡) to reduce the risk of potential shock hazards. It must be plugged into a properly grounded, independent 3-prong wall outlet. If the outlet is a 2-prong outlet, it is your personal responsibility to have a qualified electrician replace it with a properly grounded, independent 3-prong wall outlet. Do not remove the ground prong from the plug and do not use an adapter plug. Failure to follow these instructions may result in death, electric shock, or fire.
 - To reduce the risk of electric shock, do not touch the power switch or plug with damp hands.
 - Do not use an extension cord.
 - Do not use an appliance with a damaged power cord. The power cord should not be altered, jerked, bundled, weighed down, pinched, or tangled. Such actions could result in electric shock or fire. To unplug the appliance, be sure to pull the plug, not the cord, and do not jerk the cord.
 - The GREEN ground wire in the factory-installed power cord is connected to the appliance. If it becomes necessary to remove or replace the power cord, be sure to connect the power cord's ground wire.
-
- Usually an electrical permit and services of a licensed electrician are required.
 - The maximum allowable voltage variation is ± 10 percent of the nameplate rating.

Installing the Shelves

Shelves and shelf clips (4 clips per shelf) are packed inside the cabinet prior to shipment. After selecting the appropriate spacing inside the cabinet, install shelf clips by inserting top of clip inside the pilaster and then press the lower section of the clip while pushing inwards until it snaps into place. Repeat until all clips are in desired location. Place shelf on clips checking that all four corners of shelves are leveled and supported by the four shelf clips.

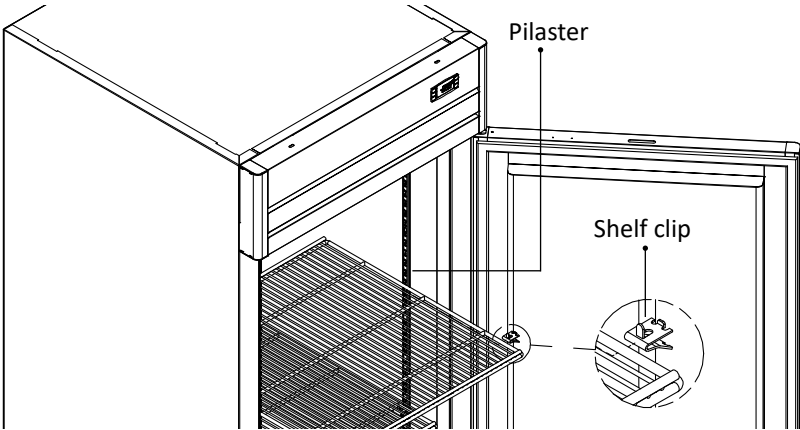

Start up the Cabinet

1. Plug in the electrical cord of the unit to a wall outlet, following the recommendations about electrical installation in this manual.
2. Let the cooler run with no product load for 2 hours, or let the compressor complete three on/off cycles to assure that the temperature inside is appropriate for the products before loading them into the freezer.
3. When placing products in the cooler, you should leave small gaps between one and the other to assure free circulation of air inside the cabinet.
4. Do not leave the door open for extended periods of time to avoid raising the temperature inside the cabinet.
5. Do not unplug your cooler during the night, since when you turn it back on during the day the electrical consumption will increase.

Factory Default Temperature Setpoint:

- Refrigerator 34°F (1.11°C)
- Freezer -5°F (-20.5°C)

The temperature of a refrigerator should be between +33°F(0.5°C) to +39°F(4°C)

The temperature of a freezer should be between -5°F(-20.5°C) to +5°F(-15°C)

Door Reversal

APPLIES ONLY FOR SINGLE DOOR MODELS

If you would like to reverse the door swing, follow the steps below. Otherwise, skip to section “Controls and adjustments.”

TOOLS



3/8" NUT DRIVER BIT



PHILLIPS # 2 SCREWDRIVER

INSTRUCTIONS

Step 1. Remove the four screws (two upper and two lower) from the header sign, then place it on top of the equipment.

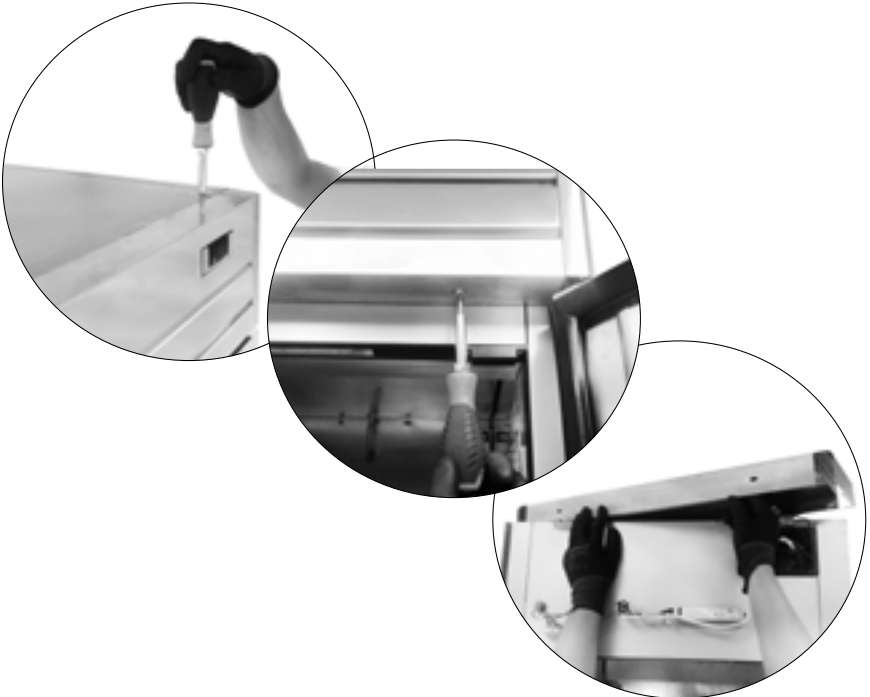

Step 2. Remove the four screws from the front grill, then remove the front grill.

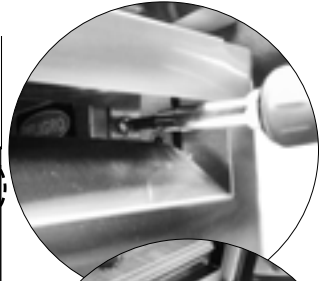
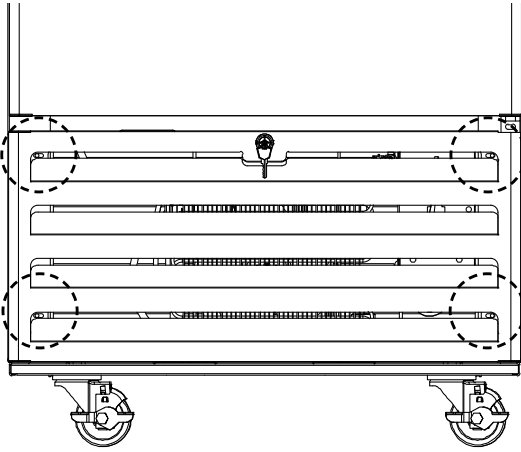

Step 3. Remove the two screws from the lower hinge and remove the door by pulling straight down until it is free of the upper hinge pin.

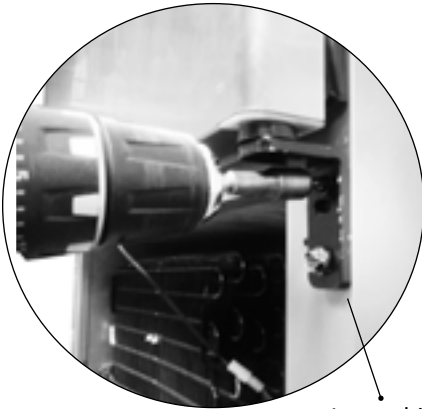

Lower hinge



Step 4. Remove the two screws from the upper hinge and place it on the opposite side of the equipment.

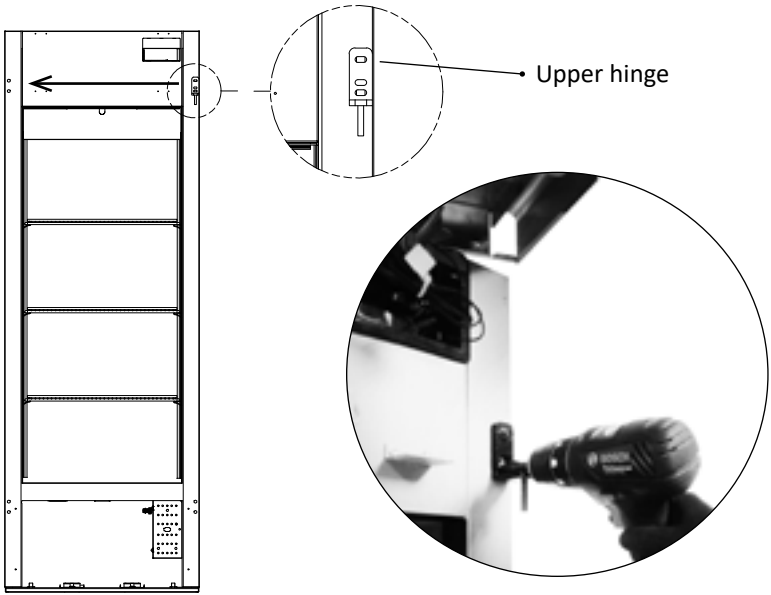

Step 5. Remove the door bushing from the upper right corner and the lower hinge with the torsion mechanism and switch them, see the image below.

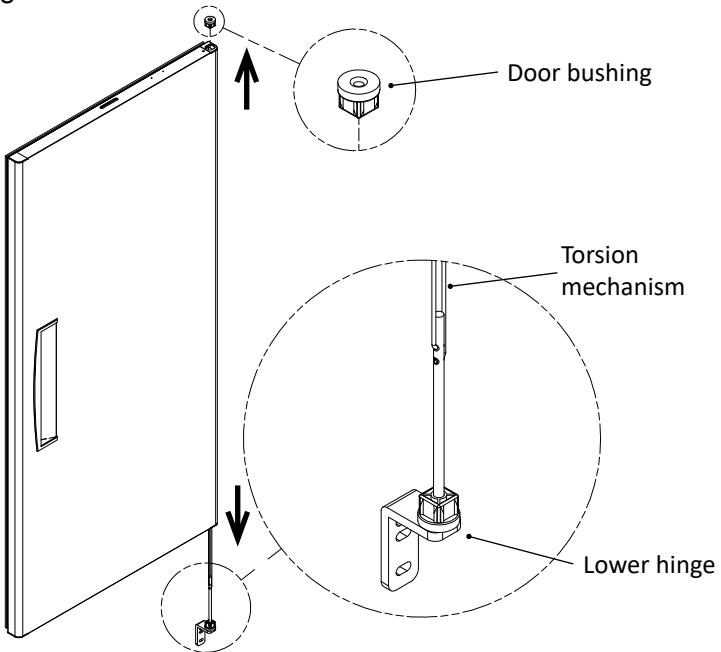

Step 6. After switching hinge and bushing position, turn the door 180°.

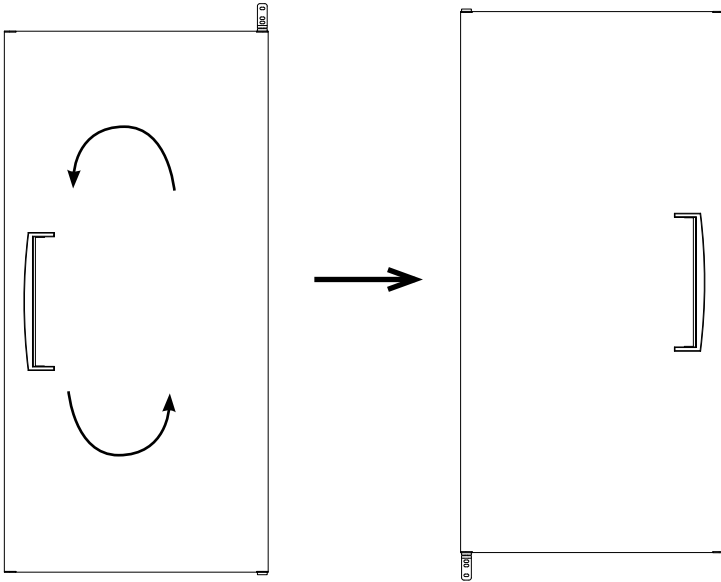

Step 7. Change the door magnet from the top to the bottom of the door.

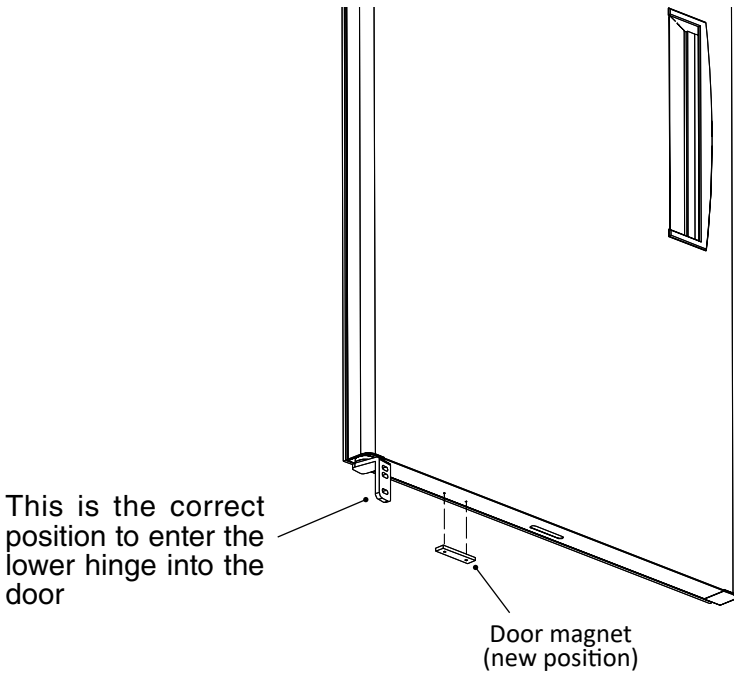

Step 8. Insert the door into the upper hinge and hold it while placing the lower hinge .

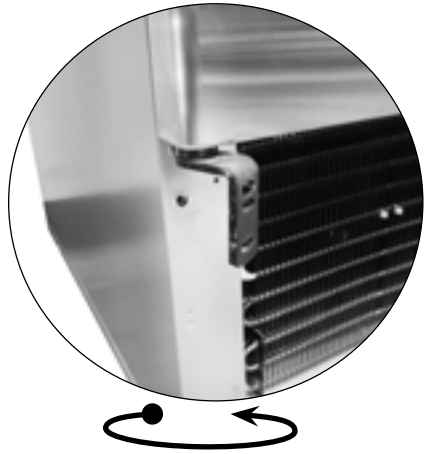

Note: Turn the hinge in the opposite direction of the door opening, then fix it to the equipment with the two screws

Step 9. Replace the lower left cap from the header sign to the upper right corner of the front grill and the upper left cap from the front grill to the lower right corner of the header sign.

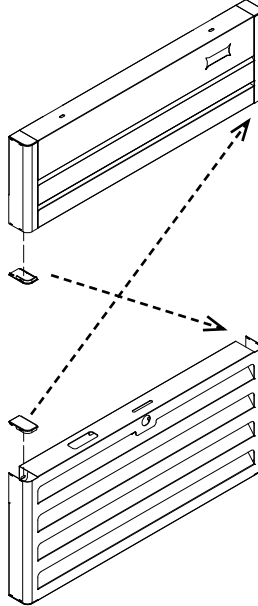

Step 9. Re-install the front grill and the header sign reversing the Steps 1 and 2.







Controls and Adjustments

Your commercial Refrigerator or Freezer is manufactured with an electronic thermostat to control various functions of your unit, such as temperature, defrost cycles, alarms, etc.



READING THE LEDS:

Each LED function is described in the following table:

LED	MODE	FUNCTION
	ON	Compressor enabled
	Flashing	Anti-short cycle delay enabled
	ON	Defrost enabled
	Flashing	* Drip time in progress
	ON	* Fans enabled
	Flashing	* Fans delay after defrost in progress
	ON	* An alarm is occurring

* Freezers only

TEMPERATURE SELECTION*

	TEMPERATURE	ITEM
REFRIGERATOR	+33°F to 39°F (+1°C to +4°C)	DIXELL XR07CH
FREEZER	-5°F to +5°F (-21°C to -15°C)	DIXELL XR07CH

**These temperatures may vary according to customer request.*

HOW TO SEE THE SET POINT

1. The set point parameter is the temperature at which the compressor cuts out.
2. Push and immediately release the SET key: the display will show the set point value.
3. Push and immediately release the SET key or wait for 5 seconds to display the probe value again.

HOW TO CHANGE THE SET POINT

1. Push the SET key for more than 5 seconds to change the SET point value.
2. The value of the set point will be displayed and the “C” or “F” LED starts blinking.
3. To change the Set value push the ▲ or ▼ arrows within 10 s.
4. To memorize the new set point value push the SET key again or wait 10 s.

DIXELL ALARM INDICATORS

Mess.	Cause	Outputs
P1	Room probe failure	Compressor output according to CY e Cn
P2	Evaporator probe failure	Defrost end is timed
P3	Third probe failure	Outputs unchanged
HA	Maximum temperature alarm	Outputs unchanged
LA	Minimum temperature alarm	Outputs unchanged
H2	Maximum temperature alarm for condenser	Outputs unchanged
L2	Minimum temperature alarm for condenser	Outputs unchanged
EA	External alarm	Outputs unchanged
CA	Serious external alarm	All outputs OFF
PA	Pressure switch alarm	All outputs OFF
dA	Door open	Depends on par. rd

Cleaning and Preventive Maintenance

Your unit requires very little maintenance. However, periodic cleaning can help maintain efficiency and prolong product life. Remember to disconnect the power source before cleaning. Remove all products and place them in another cooler.

1. Clean once a month the condenser with a grease remover. The condenser is located in the lower part of your unit, behind the front grill.

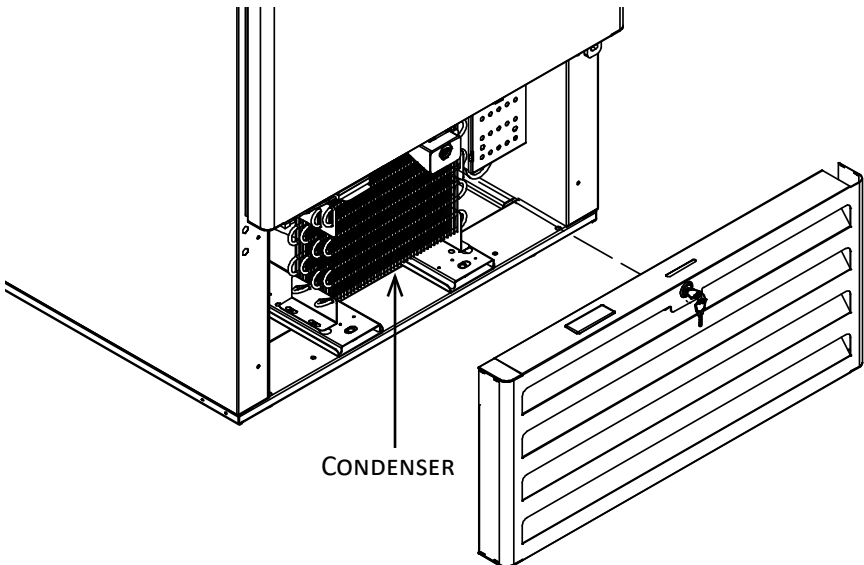

2. Clean the inside and the exterior of your cooler, including the shelves, with a mild soap solution. Do not use strong detergents. Wipe dry the inside of the cooler before loading product again.
3. Allow the appliance to cool down to setpoint before loading with product.

Disposal

 **DANGER**

FLAMMABLE 

- The appliance contains refrigerant and must be disposed of in accordance with applicable national, state, and local codes and regulations. Refrigerant must be recovered by properly certified service personnel.
- The insulation foaming agent used for the unit body contains flammable gas cyclopentane. With this in mind, dispose of the product properly.
- Remove the door to reduce the risk of children getting trapped. Leave the shelves in place so that children may not easily climb inside.

 **DANGER**

Risk of Fire or Explosion Flammable Refrigerant Used

- Follow handling instructions carefully in compliance with U.S. government regulations.
- Do not puncture refrigerant tubing. Risk of fire or explosion due to puncture of refrigerant tubing; follow handling instructions carefully.
- Dispose of properly in accordance with federal or local regulations.

Risque De Feu Ou D'Explosion Le Frigorigène Est Inflammable

- Suivre attentivement les instructions de manipulation conformément à la réglementation gouvernementale.
- Ne pas perforer la tubulure contenant le frigorigène. Risque de feu ou d'explosion si la tubulure contenant le frigorigène est perforée; suivre les instructions de manutention avec soin.
- Éliminer conformément aux règlements fédéraux ou locaux.

