





DIGITAL MEDIA FOR LEATHERCRAFTERS  
**LeathercraftLibrary.com**

Visit [www.tandy.com](http://www.tandy.com) for all the supplies needed to complete this project.  
 Visit [www.LeadercraftLibrary.com](http://www.LeadercraftLibrary.com) for more great carving patterns.

**HOT CUP WRAP**

Design by George Hurst. Pattern is reproduced at 100%.

Cut wraps from 4 to 5 oz. Vegetable Tanned Cowhide

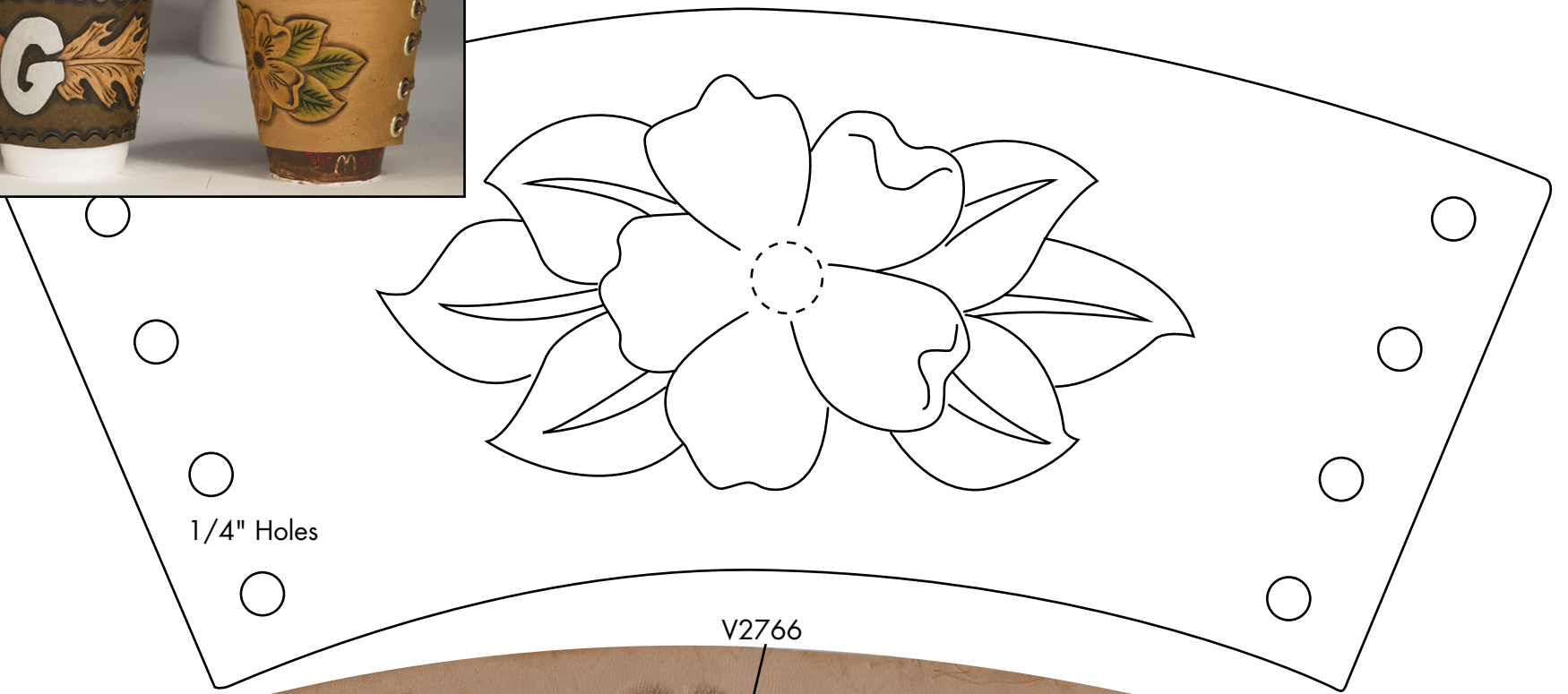

1/4" Holes

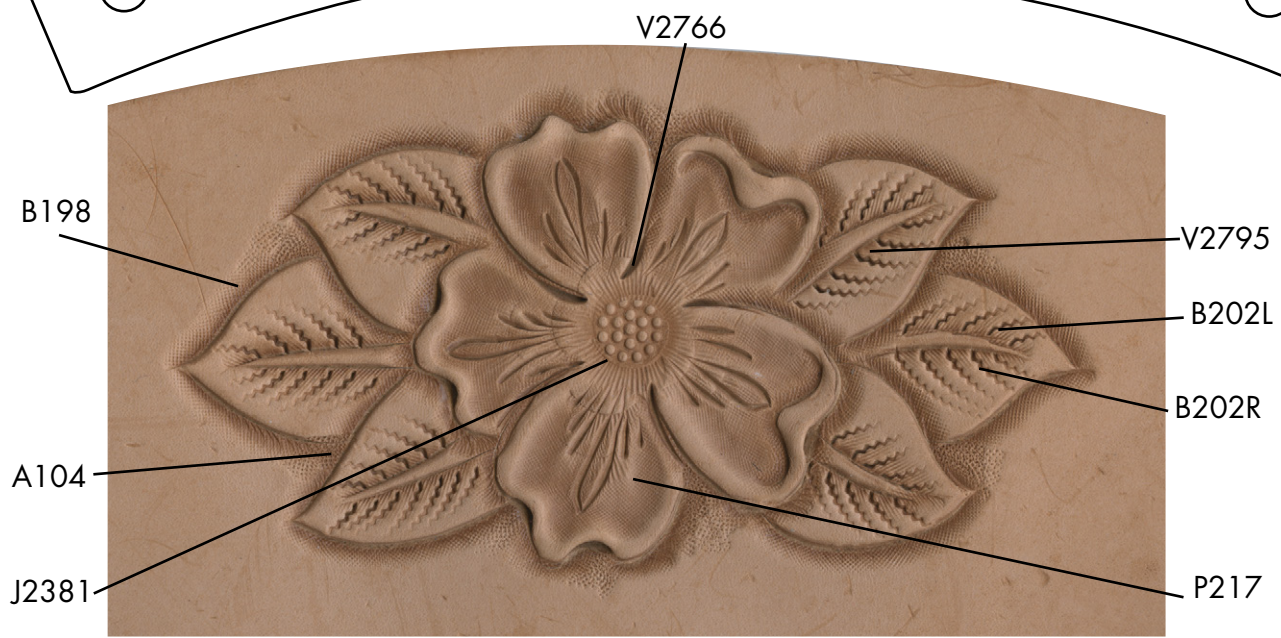

V2766

B198

V2795

B202L

B202R

A104

P217

J2381

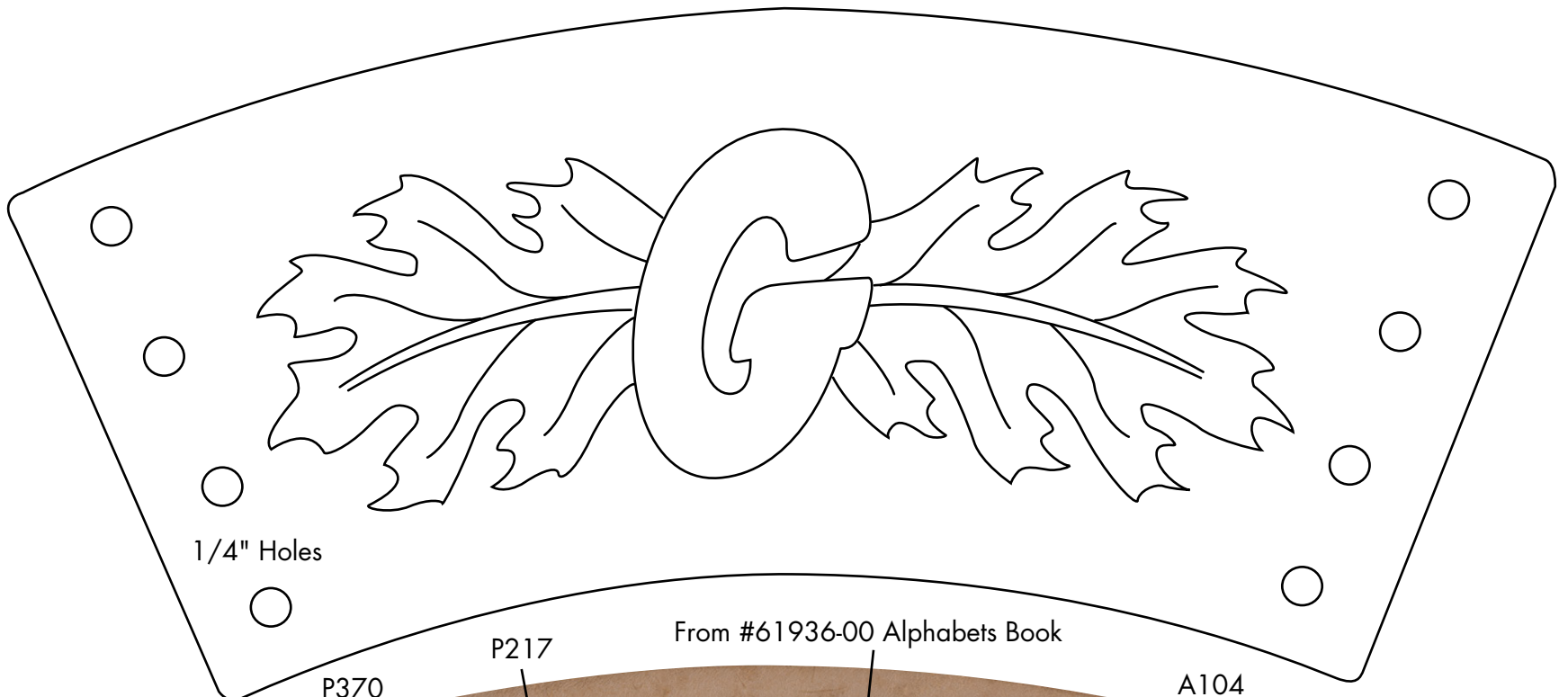

1/4" Holes

From #61936-00 Alphabets Book

P370

P217

A104

B198



B936

Hair Blade

B202L

B202R





DIGITAL MEDIA FOR LEATHERCRAFTERS

**LeathercraftLibrary.com**

Visit [www.tandyleather.com](http://www.tandyleather.com) for all the supplies needed to complete this project.  
Visit [www.LeanercraftLibrary.com](http://www.LeanercraftLibrary.com) for more great carving patterns.

### HOT CUP WRAP

Design by George Hurst. Pattern is reproduced at 100%.

Cut wraps from 4 to 5 oz. Vegetable Tanned Cowhide

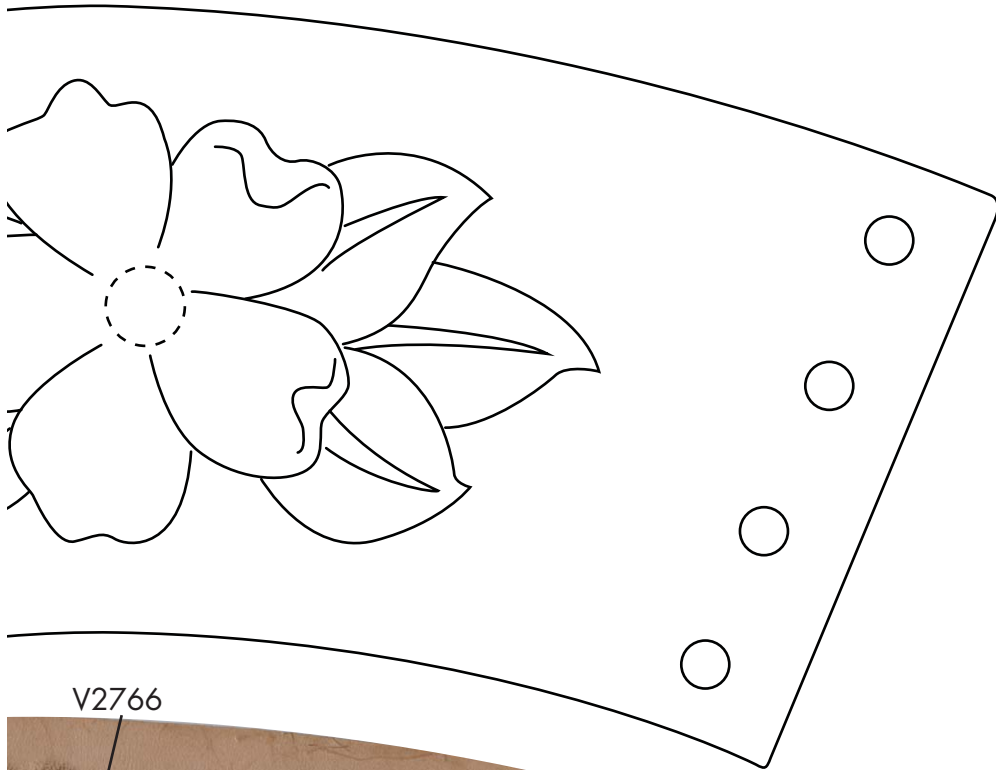

V2766



V2795

B202L

B202R

A104

J2381

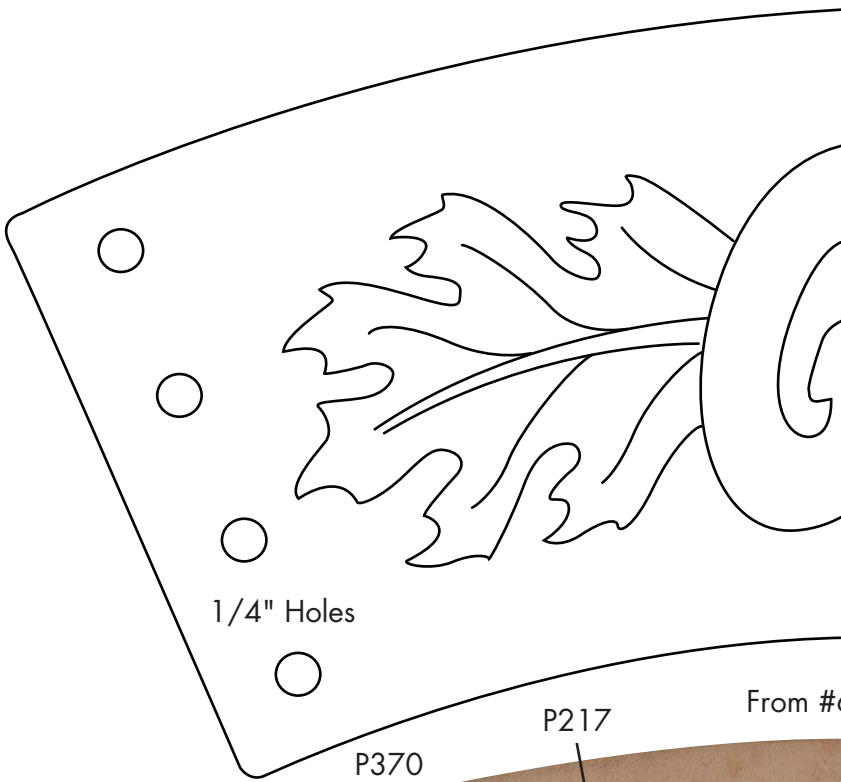
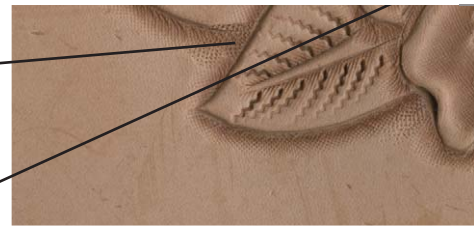

1/4" Holes

From #c

P370

P217

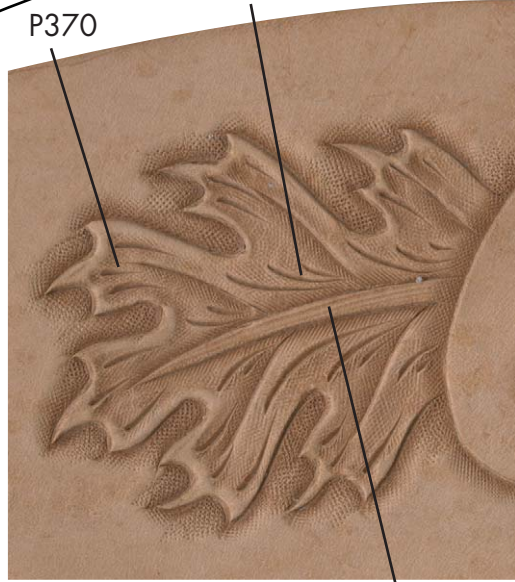

Hair Blade



©2014 Tandy Leather. All rights reserved.

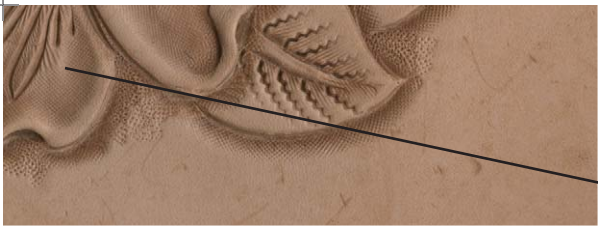

P217

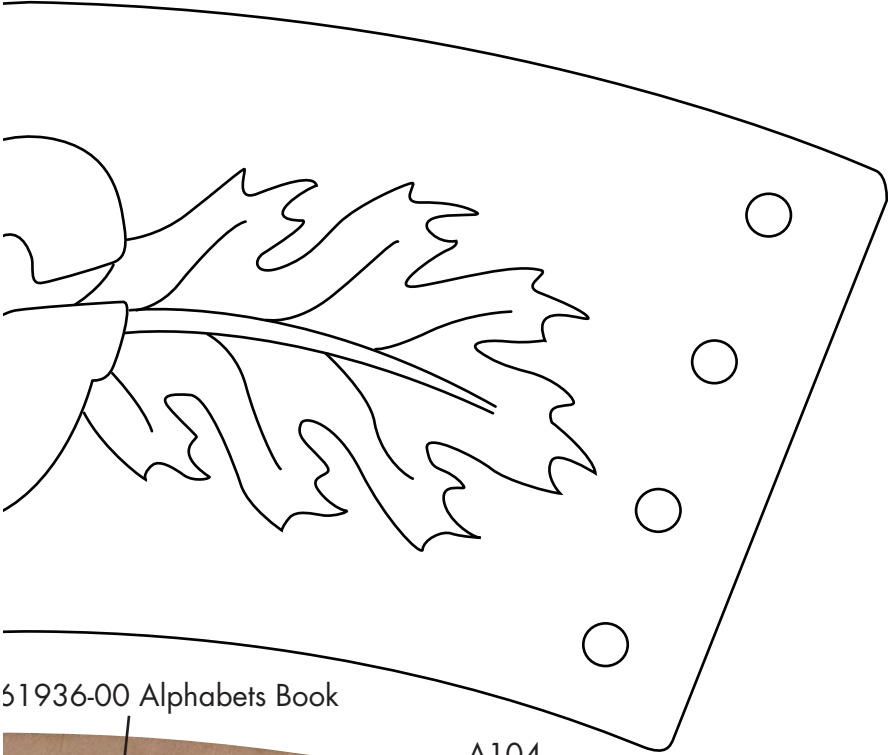

51936-00 Alphabets Book

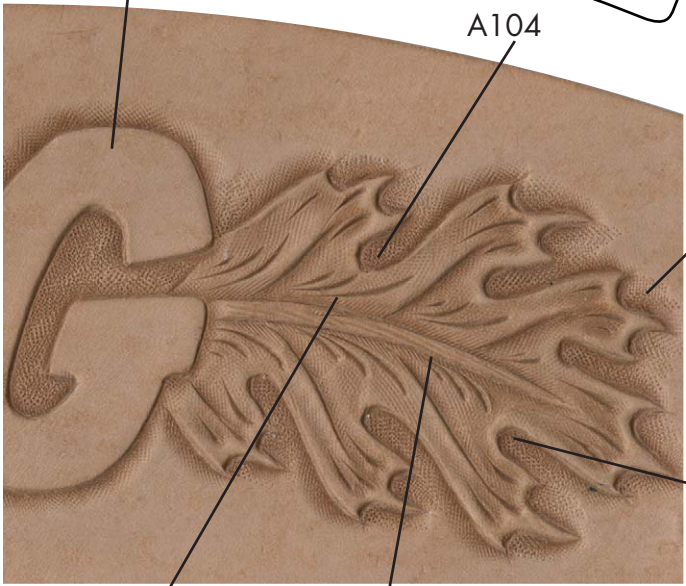

A104

B198

B936

B202L

B202R