

DH-SD4A425DB-HNY

4MP 25x Starlight IR WizSense Network PTZ Camera



Wiz Sense

Launched by Dahua Technology, WizSense is a series of AI products and solutions that adopt independent AI chip and deep learning algorithm. It focuses on human and vehicle with high accuracy, enabling users to fast act on defined targets. Based on Dahua's advanced technologies, WizSense provides intelligent, simple and inclusive products and solutions.

System Overview

With its powerful optical zoom, and accurate pan and tilt capabilities, the PTZ camera provides an all-in-one solution for long distance video surveillance of outdoor scenes. Together with infrared illumination and Starlight Technology, the camera is a great solution for dark, low light conditions. The series combines a day and night mechanical IR cut filter to produce high quality images in variable lighting conditions during the day.

Functions

Starlight Technology

With advanced image processing technology and optical technology, Dahua Starlight technology can provide clear colorful video in the environment of low illuminance. It widely applies to various environments of low illuminance.

Wide Dynamic Range

The camera produces vivid images, even in high-contrast lighting conditions, by using industry-leading wide dynamic range (WDR) technology. For scenes that quickly alternate between bright and low lighting, WDR adjusts to fully capture both the bright and dark areas of a scene, producing superior quality videos.

Perimeter Protection

Automatically filters out false alarms caused by animals, rustling leaves, bright lights, and more, and uses secondary recognition during target detection to improve alarm accuracy.

- 1/2.8" 4Megapixel STARVIS™ CMOS.
- 25x optical zoom.
- Starlight technology.
- Max. 25/30fps@4MP.
- IR distance up to 100m.
- Auto-tracking.
- Perimeter protection.
- Face detection.
- SMD 3.0.
- IP66.



Auto-tracking

This feature controls the pan/tilt/zoom actions of the camera to automatically track an object in motion and to keep it in the scene. The tracking action can be triggered manually or automatically by defined rules. Once a rule is triggered, the camera can zoom in and track the defined target automatically.

PFA Technology

PFA technology has introduced new methods of judgment that ensure the accuracy and predictability of the direction of subject distance adjustment. The result is a set of advanced focusing algorithms that ensure image clarity when zooming and that shorten focus time. This makes the camera highly advanced in its functions, substantially improving the quality of your experience.

SMD

Empowered by Deep-Learning Algorithms, Dahua SMD filters out motion detection alarms triggered by targets that are not a concern. It quickly recognizes humans and vehicles, triggering alarms when an intrusion occurs.

Environment (-40 °C to +65 °C, IP66)

Developed to operate in extreme conditions, the camera can function in temperatures ranging from -40 °C to +65 °C (-40 °F to +149 °F) at 95% humidity. It was subjected to rigorous dust and water immersion tests, gaining its IP66 Ingress Protection certification, making it suitable for demanding outdoor applications.



ONLY THE BEST DEALS FOR SECURITY PRODUCTS

SECUREON.COM.AU

P 1300 888 767

Technical Specification

Camera

Image Sensor	1/2.8" CMOS
Pixel	4 MP
Max. Resolution	2560 × 1440
ROM	128 MB
RAM	512 MB
Electronic Shutter Speed	1/1s–1/30000s
Scanning System	Progressive
Min. Illumination	Color: 0.005lux@F1.6 B/W: 0.0005lux@F1.6 0Lux (IR on)
Illumination Distance	100 m (328.08 ft) (IR)
Illuminator On/Off Control	Zoom Prio; Manual; Auto; Off
Illuminator Number	6 (IR)

Lens

Focal Length	5 mm–125 mm			
Max. Aperture	F1.6–F3.6			
Field of View	H: 51.9°–3.0° V: 39.7°–2.2° D: 63.1°–3.7°			
Optical Zoom	25x			
Focus Control	Auto; semi-auto; manual			
Close Focus Distance	0.5 m–5 m (1.64 ft–16.40ft)			
Iris Control	Auto; manual; fixed			
DORI Distance	Detect	Observe	Recognize	Identify
	2500 m (8202.10 ft)	987.5 m (3239.83 ft)	500 m (1640.42 ft)	250 m (820.21 ft)

PTZ

Pan/Tilt Range	Pan: 0° to 360° endless Tilt: –5° to +90°, auto flip 180°
Manual Control Speed	Pan: 0.1°/s–240°/s Tilt: 0.1°/s–160°/s
Preset Speed	Pan: 240°/s; Tilt: 160°/s
Preset	300
Tour	8 (up to 32 presets per tour)
Pattern	5
Scan	5
Power-off Memory	Yes
Idle Motion	Pattern; Preset; Scan; Tour
PTZ Protocol	DH-SD

Intelligence

IVS (Perimeter Protection)	Tripwire; intrusion; crossing fence detection; loitering detection; abandoned/missing object; fast moving; parking detection; people gathering; vehicle/human alarm classification; linkage tracking
----------------------------	---

Face Detection	Supports face detection, face track box, capturing pictures, face enhancement; Supports face cutout: Face, one-inch photo. Capturing strategies include real-time capturing and quality first
Auto Tracking	Yes
SMD	Yes

Video

Video Compression	H.264H; H.264B; Smart H.265+; H.264; H.265; MJPEG(Sub Stream); Smart H.264+
Streaming Capability	3 streams
Resolution	4M (2560 × 1440); 3M (2304 × 1296); 1080P (1920 × 1080); 1.3M (1280 × 960); 720P (1280 × 720); D1 (704 × 576); VGA (640 × 480); CIF(352 × 288)
Video Frame Rate	Main stream: 4M/3M/1080p/1.3M/720p @(1–25/30 fps) Sub stream 1: D1/VGA/CIF@ (1–25/30 fps) Sub stream 2: 720p/CIF @(1–25/30 fps)
Bit Rate Control	CBR/VBR
Video Bit Rate	H.264: 96Kbps - 14848Kbps H.265: 38Kbps - 8960Kbps
Day/Night	Auto (ICR)/Color/B/W
BLC	Yes
WDR	120 dB
HLC	Yes
White Balance	Auto; indoor; outdoor; ATW; manual; sodium lamp; natural light; street lamp
Gain Control	Auto; manual
Noise Reduction	2D NR; 3D NR
Motion Detection	Yes
Region of Interest (RoI)	Yes
Image Stabilization	Electronic (EIS)
Defog	Electronic
Digital Zoom	16x
Image Rotation	180°
Privacy Masking	Up to 24 areas can be set, with up to 8 areas in the same view
S/N Ratio	≥ 55 dB

Audio

Audio Compression	G.711a; G.711Mu; G.726; MPEG2-Layer2; G722.1; PCM; AAC
-------------------	--

Network

Network Port	RJ-45 (10/100 Base-T)
Network Protocol	FTP; RTMP; IPv6; Bonjour; IPv4; DNS; RTCP; PPPoE; NTP; RTP; 802.1x; HTTPS; SNMP; TCP/IP; DDNS; UPnP; NFS; ICMP; UDP; IGMP; HTTP; SSL; DHCP; SMTP; Qos; RTSP; ARP; ;SAMB A
Interoperability	CGI; SDK; ONVIF (Profile S&G&T); P2P
Streaming Method	Unicast/Multicast

User/Host	20 (total bandwidth: 64 M)
Storage	Micro SD card (512 GB); FTP/SFTP; NAS
Browser	IE 9 and later versions Chrome 41 and later versions Firefox 50 and later versions iOS 10 and later versions
Management Software	DMSS; DSS PRO
Mobile Client	iOS; Android
Certification	
Certifications	CE: EN55032/EN55024/EN50130-4 FCC: Part15 subpartB, ANSI C63.4-2014
Port	
Audio Input	1 channel (LINE IN, bare wire)
Audio Output	1 channel (LINE OUT, bare wire)
Alarm Linkage	Capture; preset; tour; pattern; recordings on SD card; alarm digital input; send email
Alarm Event	Motion/Tampering detection; audio detection; network disconnection detection; IP conflict detection; memory card state detection; memory space detection
Alarm I/O	2/1
Audio I/O	1/1
Power	
Power Supply	12 VDC/2 A ± 10% (included) PoE+ (802.3at)
Power Consumption	Basic: 9.5 W Max.: 21.5 W (illuminator on + fan on + PTZ)
Environment	
Operating Temperature	-40 °C to +65 °C (-40 °F to +149 °F)
Operating Humidity	≤ 95%
Protection	IP66, TVS 6000 V lightning proof; surge protection; voltage transient protection
Structure	
Product Dimensions	170.4 mm × Φ171.1 mm (6.71" × Φ6.74")
Net Weight	2.5 kg (5.51 lb)
Gross Weight	3.2 kg (7.05 lb)

Ordering Information

Type	Model	Description
4MP PTZ Camera	DH-SD4A425DB-HNY	4MP 25x Starlight IR WizSense Network PTZ Camera
	SD4A425DB-HNY	4MP 25x Starlight IR WizSense Network PTZ Camera
Accessories	DC 12 V/2 A	Power Adapter
	PFA101	Mount Adapter
	PFB303W	Wall Mount Bracket
	PFB300C	Ceiling Mount Bracket
	PFA150	Pole Mount Bracket
	PFA151	Corner Mount Bracket
	PFB303S	Parapet Mount Bracket
	PFM900-E	Integrated Mount Tester
TF-P100	MicroSD Memory Card	

Accessories

Included:



DC 12 V/2A
Power Adapter

Optional:



PFA101
Mount Adapter



PFB303W
Wall Mount
Bracket



PFB300C
Ceiling Mount
Bracket



PFA150
Pole Mount
Bracket



PFA151
Corner Mount
Bracket



PFB303S
Parapet Mount
Bracket



PFM900-E
Integrated Mount
Tester



TF-P100
MicroSD Memory
Card



ONLY THE BEST DEALS FOR SECURITY PRODUCTS

SECUREON.COM.AU

P 1300 888 767

Installation

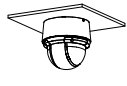
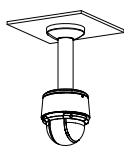
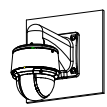
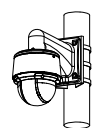
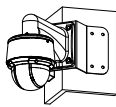
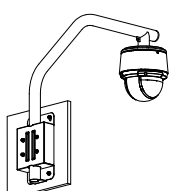
Ceiling Mount	Ceiling Mount PFB300C+PFA101	Wall Mount PFB303W+PFA101
		
Pole Mount (Vertical) PFA150+PFB303W+PFA101	Corner Mount PFA151+PFB303W+PFA101	Parapet Mount PFB303S+PFA101
		

Dimensions (mm [inch])

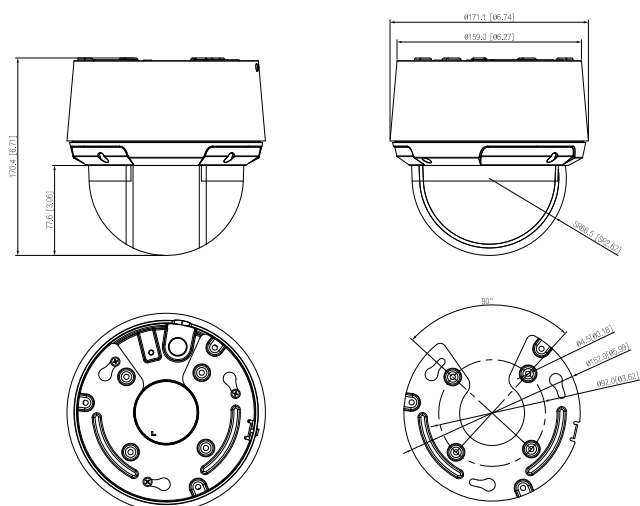

ONLY THE BEST DEALS FOR SECURITY PRODUCTS

SECUREON.COM.AU

P 1300 888 767