



SuperLine & Implantium
Product/Manual Catalog

Dentium
For Dentists By Dentists

SuperLine & Implantium

A New Choice

For the Customer

Contents

Introduction

S.L.A. Surface	04
SuperLine Characteristics	06
SuperLine Color Coding by Diameter	08
SuperLine Fixture	09
IMPLANTIUM Characteristics	12
IMPLANTIUM Color Coding by Diameter	14
IMPLANTIUM Fixture	15

Surgical Components

Cover Screw	16
Healing Abutment	17

Prosthetic Procedure 1

Dual / Combi Abutment - Abutment Level Impression	18
Combi Abutment	19
Dual Abutment [Hex]	20
Dual Abutment [Non-hex]	21
Abutment Level Impression Components	22
Restorative Kit	23

Prosthetic Procedure 2

Dual / Custom / Dual Milling / Angled / Direct-Casting / Metal-Casting / Temporary (Plastic & Ti) Abutment - Fixture Level Impression	24
Fixture Level Impression Components	25
Custom Abutment	27
Dual Milling Abutment [Ti-G4]	28
Dual Milling Abutment [Ti-G2]	30
Angled Abutment [Ti-G4 / 15°]	32
Angled Abutment [Ti-G4 / 25°]	33
Angled Abutment [Ti-G2 / 15°]	34
Angled Abutment [Ti-G2 / 25°]	35
Direct-Casting Abutment	36
Metal-Casting Abutment	36
Temporary Abutment	37

Prosthetic Procedure 3

Screw Abutment - Abutment Level Impression	38
Screw Abutment	39
Angled Screw Abutment	40
Screw Abutment Impression Components	41

Prosthetic Procedure 4

Overdenture Procedure	
- Positioner / Mini Ball / Magnetic Attachment	44
Positioner	46
Mini Ball Attachment	48
Magnetic Attachment (Dome Type)	49
Magnetic Attachment (Flat Type)	50

Instruments

Surgical Kit (Full)	51
Surgical Kit (Standard)	52
Surgical Kit (Short Implant)	53
Drill Stopper Kit	54
Drill	55
Stopper	59
Instrument	60
DASK	63
Sinus Bur Kit / Sinus Kit	64
DASK / Sinus Bur Kit / Sinus Kit	65
Osteotome Kit	66
Trephine Kit	67
Prosthetic Kit	68
Planning Kit	69
Prosthetic and Laboratory Instrument	70
Help Kit	72

Surgical Manual	73
Prosthesis Manual	83



S.L.A. Surface

S.L.A. (Sandblasting with large grit and acid etching)

- Higher bone-to-implant contact.
- Faster bone formation on the surface.

In vivo test



SuperLine

SuperLine Characteristics

"Immediate Implantation with Excellent Bone Response"

- Higher stabilization in extraction socket
- Early loading in upper posterior
- Harmony with anatomy
- Sharp & fast insertion

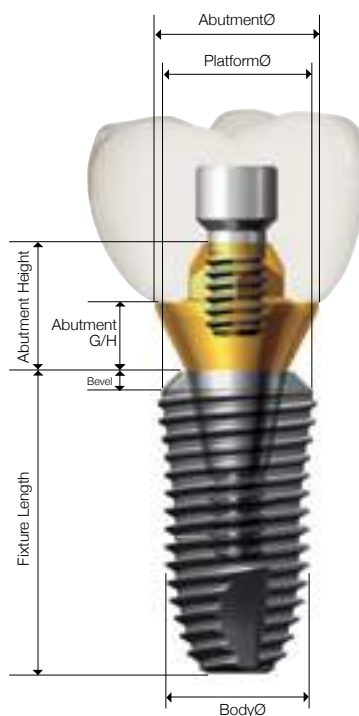
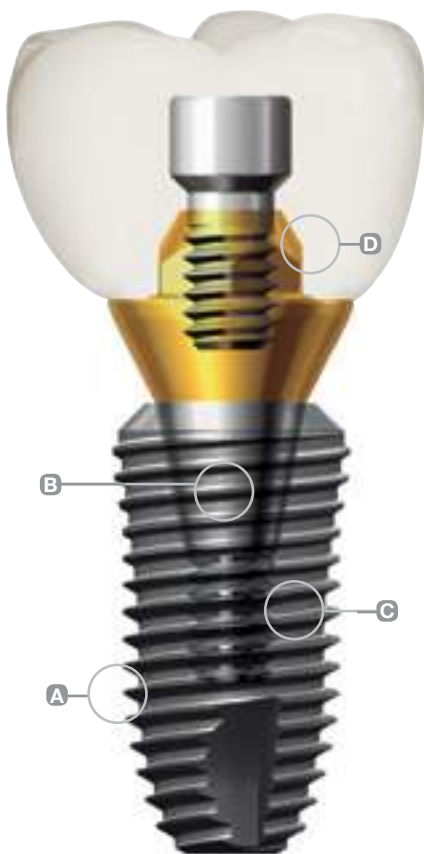

Selection Guideline

Ideal emergence profile for each tooth



SuperLine Characteristics

A Tapered Design



- Tapered load distribution may achieve excellent bone response.
- Tapered design may harmonize with surrounding bone anatomically.
- The large surface area helps provide excellent initial stability with sinus augmentation.

B Biological Connection



- The conical hex connection between implant and abutment interface ensures hermetic sealing.
- The biologic connection distributes the load to the fixture evenly. Therefore it helps minimize micro-movement and marginal bone loss.
- All implant diameters share the same internal hex.

C-1 Double Thread & Thread Height

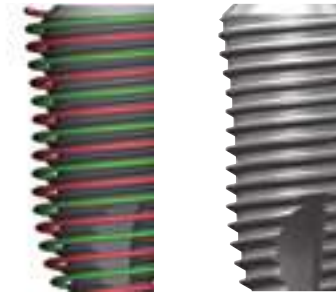

- Increased thread height helps increase the initial stability.
- Double thread may decrease the chair time of implantation

C-2 Osseointegration

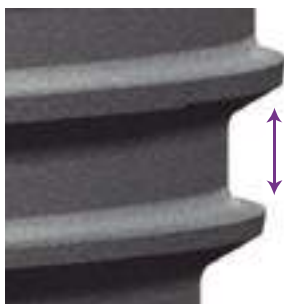

- The greater distance between the threads may promote early osseointegration

D Prosthesis

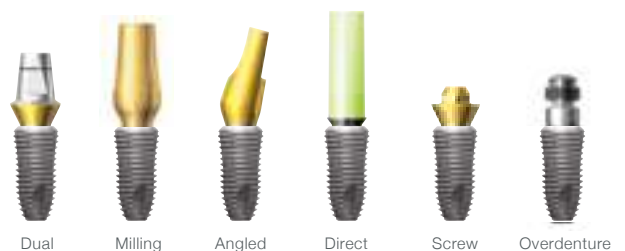

- One abutment screw fits all abutments and fixture platforms.
- Single abutment connection is used for all implant diameters.
- One hex screw driver fits all abutment screws

SuperLine Color Coding by Diameter

Color Coding by Diameter

• Cover screw is not included.

(Unit: mm)

Cap Color							
Fixture SuperLine (Mount Free)							
 PlatformØ	Fixture Platform Diameter	3.6	4.0	4.5	5.0	6.0	7.0
 BodyØ	Fixture Body Diameter	3.4	3.8	4.3	4.8	4.8	5.8
 Bevel	L : 7 Fixture Bevel Height	0	0.5	1.5	1.5	1.5	1.5
 Bevel	L : 8, 10, 12, 14 Fixture Bevel Height	0	0.1	0.3	0.4	0.7	1.0



SuperLine Fixture

Unit: mm, Scale 1 : 1.5 / mm

Platform Ø3.6 | Body Ø3.4

L	Art. No.
7	FX 36 07 SW
8	FX 36 08 SW
10	FX 36 10 SW
12	FX 36 12 SW
14	FX 36 14 SW

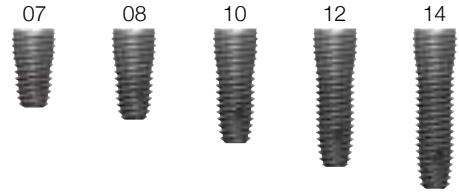
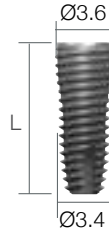

Platform Ø4.0 | Body Ø3.8

L	Art. No.
7	FX 40 07 SW
8	FX 40 08 SW
10	FX 40 10 SW
12	FX 40 12 SW
14	FX 40 14 SW

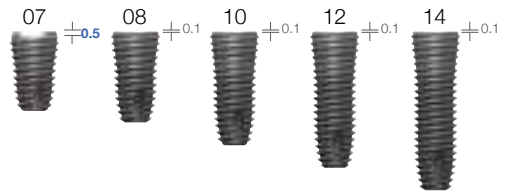
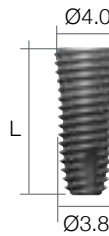

Platform Ø4.5 | Body Ø4.3

L	Art. No.
7	FX 45 07 SW
8	FX 45 08 SW
10	FX 45 10 SW
12	FX 45 12 SW
14	FX 45 14 SW

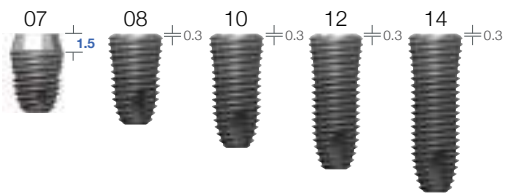
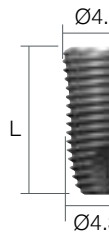

Platform Ø5.0 | Body Ø4.8

L	Art. No.
7	FX 50 07 SW
8	FX 50 08 SW
10	FX 50 10 SW
12	FX 50 12 SW
14	FX 50 14 SW

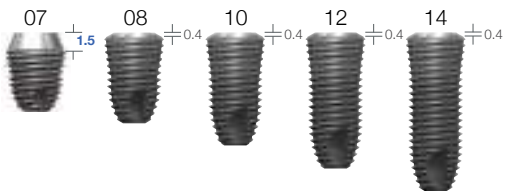
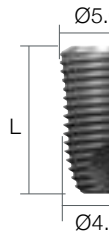

*Note: 1) To prevent damage to the Implant driver or fixture, do not over torque during fixture insertion

SuperLine Fixture

Unit: mm, Scale 1 : 1.5 / mm

Platform Ø6.0 | Body Ø4.8

L	Art. No.
7	FX 60 07 SW
8	FX 60 08 SW
10	FX 60 10 SW
12	FX 60 12 SW

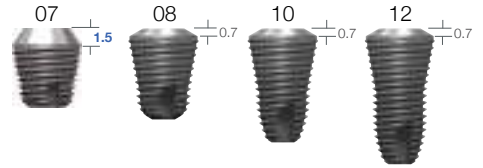

Platform Ø7.0 | Body Ø5.8

L	Art. No.
7	FX 70 07 SW
8	FX 70 08 SW
10	FX 70 10 SW
12	FX 70 12 SW

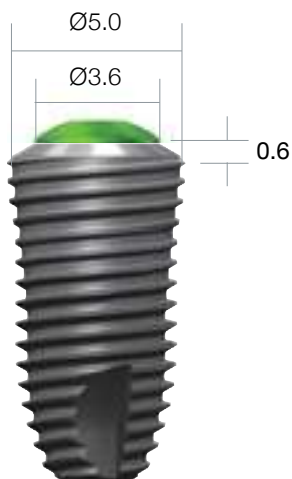
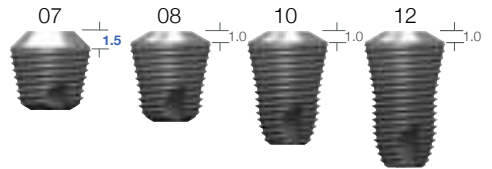

FX5010SW and CS36



FX5010SW and HAB552035L

A close-up, vertical view of a metal drill bit. The bit is dark grey and features a series of sharp, pointed flutes that spiral around its length. The lighting is dramatic, highlighting the metallic texture and the sharp edges of the flutes. The word "IMPLANTIUM" is overlaid in the center of the image in a white, sans-serif font. A thin vertical line passes through the letter 'I' in "IMPLANTIUM", extending slightly above and below the text.

IMPLANTIUM

Implantium Characteristics

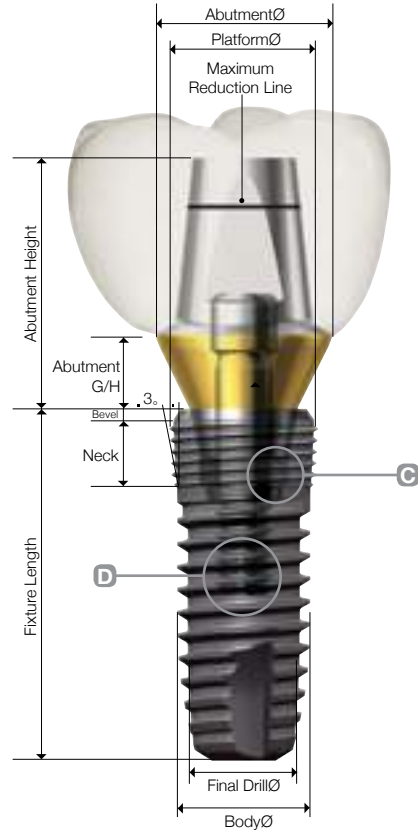

Selection Guideline

Ideal emergence profile for each tooth



Implantium Characteristics

A Optimal Fixation Threads



- Synchronized positive neck threads.
- Initial stability & maximum sealing between the cortical bone and fixture.
- Optimal fixation threads reduce stress of marginal cortical bone and minimize marginal bone loss.

C Biological Connection



- The conical hex connection between implant and abutment interface ensures hermetic sealing.
- The biologic connection distributes the load to the fixture evenly. Therefore it helps minimize micro-movement and marginal bone loss.
- All implant diameters share the same internal hex.

E Bacteria Resistant Bevel

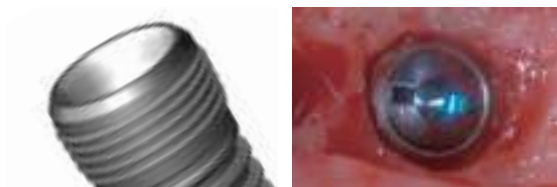

- The tapered bevel platform design may make bone profiling unnecessary at 1st, 2nd surgery.

G Cutting Edge



- The 3 blade self tapping design minimizes bone destruction.
- Tapered apical shape promotes easier insertion.

B Biological Thread

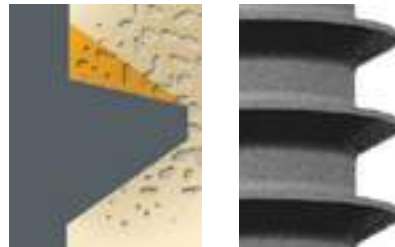

- Thread platform design creates excellent bone to implant contact.
- Threads engage and penetrate bone with ease.

D Abutment Screw



- One abutment screw fits all abutments and fixture platforms.
- One hex screw driver fits all abutment screws.

F Abutment TiN-Coating



- Esthetic gold color with TiN-coating.

H Flat End



- The flat end design reduces bone perforation risk.

Implantium Color Coding by Diameter

Color Coding by Diameter

• Cover screw is not included.

(Unit: mm)

Cap Color					
		Yellow	Green	Blue	Red
Fixture Implantium (Mount Free)					
 PlatformØ	Fixture Platform Diameter	3.6	4.0	4.5	5.0
 BodyØ	Fixture Body Diameter	3.4	3.8	4.3	4.8
 Bevel	Fixture Bevel Height	0.15	0.2	0.4	0.6



Implantium Fixture

Unit: mm, Scale 1 : 1.5 / mm

Platform Ø3.6 | Body Ø3.4

L	Art. No.
8	FX 34 08
10	FX 34 10
12	FX 34 12
14	FX 34 14

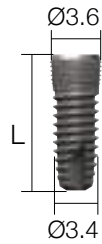

Platform Ø4.0 | Body Ø3.8

L	Art. No.
8	FX 38 08
10	FX 38 10
12	FX 38 12
14	FX 38 14



Platform Ø4.5 | Body Ø4.3

L	Art. No.
8	FX 43 08
10	FX 43 10
12	FX 43 12
14	FX 43 14

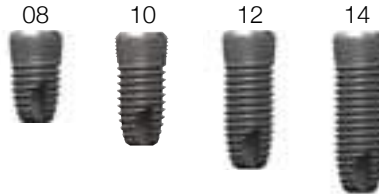

Platform Ø5.0 | Body Ø4.8

L	Art. No.
8	FX 48 08
10	FX 48 10
12	FX 48 12
14	FX 48 14

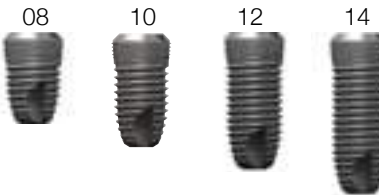

※ Note: 1) When placing the Implantium Ø3.4 body fixture, the Implant driver may not fit into the fixture properly because the hex depth is shorter than other diameters. In this case, separate the Implant driver from the fixture and reinsert.
 2) To prevent damage to the Implant driver or fixture, do not over torque during fixture insertion

Cover Screw

- Single use only

Unit: mm, Scale 1 : 1.5 / mm



CS36 and FX4510SW

Color: Green

Art. No.	CS36
----------	------



※ Hex driver: Use no more than 5N·cm torque when screwing a cover screw to a fixture.
If hex is worn, slot on the head of the product can be used to rotate it.

Healing Abutment

• Single use only

Unit: mm, Scale 1 : 1.5 / mm

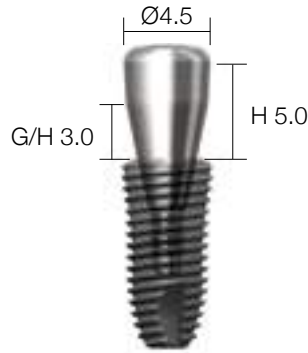

HAB453050L and FX4510SW

Diameter Ø4.0

G/H	H	Art. No.
2.0	2.0	HAB 40 20 20 L
2.0	3.5	HAB 40 20 35 L
3.0	5.0	HAB 40 30 50 L
4.0	7.0	HAB 40 40 70 L

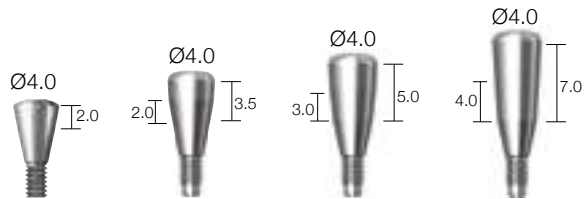

Diameter Ø4.5

G/H	H	Art. No.
2.0	2.0	HAB 45 20 20 L
2.0	3.5	HAB 45 20 35 L
3.0	5.0	HAB 45 30 50 L
4.0	7.0	HAB 45 40 70 L

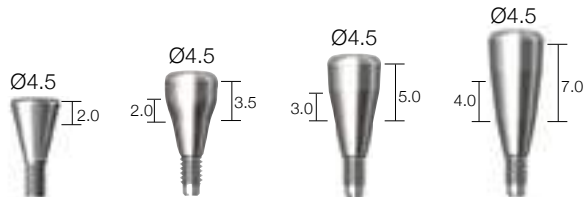

Diameter Ø5.5

G/H	H	Art. No.
2.0	2.0	HAB 55 20 20 L
2.0	3.5	HAB 55 20 35 L
3.0	5.0	HAB 55 30 50 L
4.0	7.0	HAB 55 40 70 L

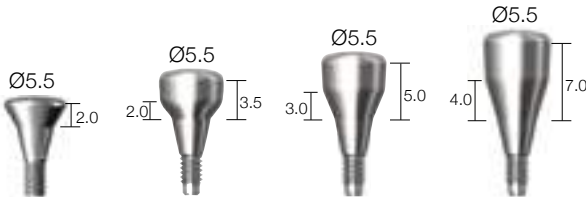

Diameter Ø6.5

G/H	H	Art. No.
2.0	2.0	HAB 65 20 20 L
2.0	3.5	HAB 65 20 35 L
3.0	5.0	HAB 65 30 50 L
4.0	7.0	HAB 65 40 70 L

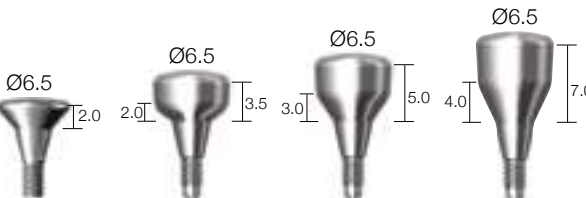

Diameter Ø7.5 / 8.5 / 9.5

G/H	H	Art. No.
3.0	5.0	HAB 75 30 50 L
3.0	5.0	HAB 85 30 50 L
3.0	5.0	HAB 95 30 50 L



※Hex driver: Use no more than 10N-cm of torque when screwing a healing abutment to a fixture.
If hex is worn, slot on the head of the product can be used to rotate it.

Prosthetic Procedure 1

Impression Technique and Restoration Selection

Dual / Combi Abutment

Abutment Level Impression

Closed Tray Technique



Impression Coping

Transfer (Snap on) Ø4.5 / Ø5.5 / Ø6.5

Page 22

Analog

Long Ø4.5 / Ø5.5 / Ø6.5

Page 22

Analog

Short Ø4.5 / Ø5.5 / Ø6.5

Page 22

Burn-out Cylinder

Bridge

Rotational
Ø4.5 / Ø5.5 / Ø6.5

Page 22

Single

Non-rotational
Ø4.5 / Ø5.5 / Ø6.5

Page 22

Modification

Cemented Restoration

Combi Abutment

Unit: mm, Scale 1 : 1 / mm



CAB5535SL and FX4510SW



CAB5535L and FX4510SW

Diameter Ø4.5

G/H	Type	Art. No.	Type	Art. No
1.0	Short	CAB 45 10 SL	Long	CAB 45 10 L
1.5		CAB 45 15 SL		CAB 45 15 L
2.5		CAB 45 25 SL		CAB 45 25 L
3.5		CAB 45 35 SL		CAB 45 35 L
4.5		CAB 45 45 SL		CAB 45 45 L
5.5		CAB 45 55 SL		CAB 45 55 L

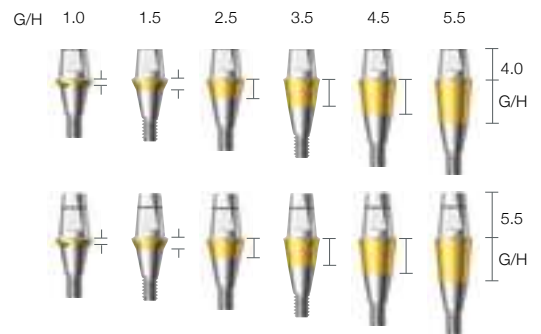

Diameter Ø5.5

G/H	Type	Art. No.	Type	Art. No
1.5	Short	CAB 55 15 SL	Long	CAB 55 15 L
2.5		CAB 55 25 SL		CAB 55 25 L
3.5		CAB 55 35 SL		CAB 55 35 L
4.5		CAB 55 45 SL		CAB 55 45 L
5.5		CAB 55 55 SL		CAB 55 55 L

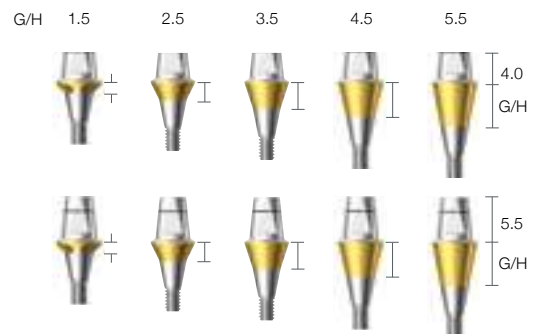

Diameter Ø6.5

G/H	Type	Art. No.	Type	Art. No
1.5	Short	CAB 65 15 SL	Long	CAB 65 15 L
2.5		CAB 65 25 SL		CAB 65 25 L
3.5		CAB 65 35 SL		CAB 65 35 L
4.5		CAB 65 45 SL		CAB 65 45 L
5.5		CAB 65 55 SL		CAB 65 55 L

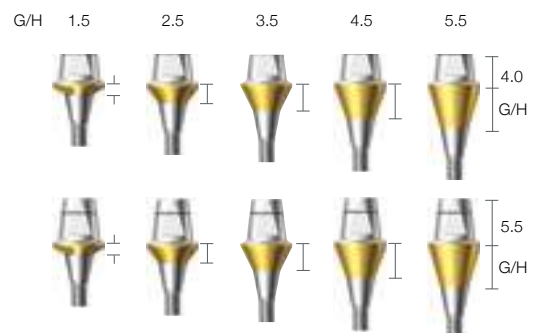

※ Note: 1) If the Implantium fixture with size of Ø3.4 body is used, abutment height after assembly will become 0.5mm longer than other sized fixtures.

2) It is recommended to keep the torque level at 25~30 N·cm to tighten the combi abutment with fixture.

Dual Abutment [Hex]

- Abutment screw is included.

Unit: mm, Scale 1 : 1.5 / mm



DAB5535HL and FX4510SW

Diameter Ø4.5 | Hex

G/H	Art. No.
1.0	DAB 45 10 HL
1.5	DAB 45 15 HL
2.5	DAB 45 25 HL
3.5	DAB 45 35 HL
4.5	DAB 45 45 HL
5.5	DAB 45 55 HL

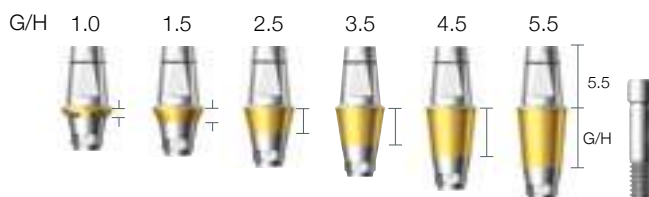

Diameter Ø5.5 | Hex

G/H	Art. No.
1.5	DAB 55 15 HL
2.5	DAB 55 25 HL
3.5	DAB 55 35 HL
4.5	DAB 55 45 HL
5.5	DAB 55 55 HL

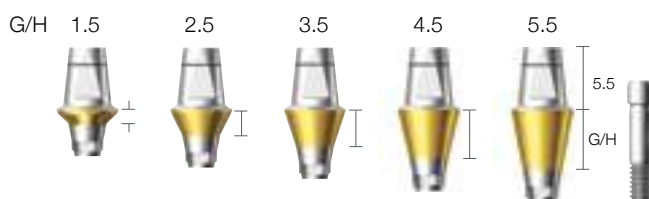

Diameter Ø6.5 | Hex

G/H	Art. No.
1.5	DAB 65 15 HL
2.5	DAB 65 25 HL
3.5	DAB 65 35 HL
4.5	DAB 65 45 HL
5.5	DAB 65 55 HL

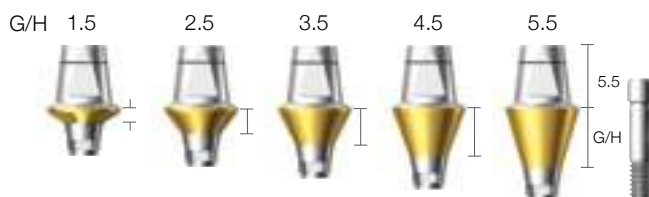

※ Note: 1) If the Implantium fixture with size of Ø3.4 body is used, abutment height after assembly will become 0.5mm longer than other sized fixtures.
 2) It is recommended to keep the torque level at 25~30 N·cm to tighten the dual abutment with fixture.

Dual Abutment [Non-hex]

• Abutment screw is included.

Unit: mm, Scale 1 : 1.5 / mm



DAB5535NL and FX4510SW

Diameter Ø4.5 | Non-hex

G/H	Art. No.
1.0	DAB 45 10 NL
1.5	DAB 45 15 NL
2.5	DAB 45 25 NL
3.5	DAB 45 35 NL
4.5	DAB 45 45 NL
5.5	DAB 45 55 NL

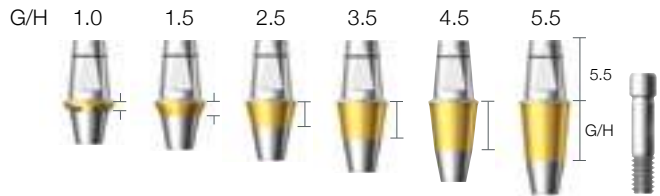

Diameter Ø5.5 | Non-hex

G/H	Art. No.
1.5	DAB 55 15 NL
2.5	DAB 55 25 NL
3.5	DAB 55 35 NL
4.5	DAB 55 45 NL
5.5	DAB 55 55 NL

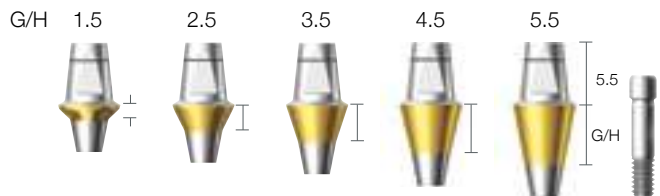

Diameter Ø6.5 | Non-hex

G/H	Art. No.
1.5	DAB 65 15 NL
2.5	DAB 65 25 NL
3.5	DAB 65 35 NL
4.5	DAB 65 45 NL
5.5	DAB 65 55 NL

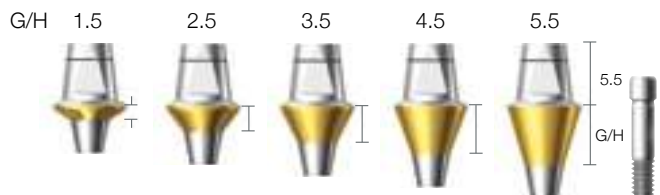

※ Note: 1) If the Implantium fixture with size of Ø3.4 body is used, abutment height after assembly will become 0.5mm longer than other sized fixtures.

2) It is recommended to keep the torque level at 25~30 N·cm to tighten the dual abutment with fixture.

Abutment Level Impression Components

Unit: mm, Scale 1 : 1 / mm

Comfort Cap | Snap on

Type	Diameter	Art. No.
Short	Ø4.5	CCC 45 CS
	Ø5.5	CCC 55 CS
	Ø6.5	CCC 65 CS
Long	Ø4.5	CCC 45 C
	Ø5.5	CCC 55 C
	Ø6.5	CCC 65 C



Impression Coping

Diameter	Art. No.
Ø4.5	CIC 45 L
Ø5.5	CIC 55 L
Ø6.5	CIC 65 L



Lab Analog

Type	Diameter	Art. No.
Short	Ø4.5	CAN 45 SL
	Ø5.5	CAN 55 SL
	Ø6.5	CAN 65 SL
Long	Ø4.5	CAN 45 LL
	Ø5.5	CAN 55 LL
	Ø6.5	CAN 65 LL

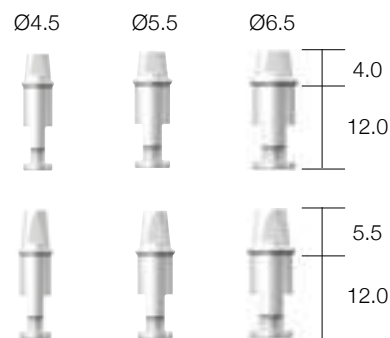

Burn-out Cylinder

Type	Diameter	Art. No.
Single	Ø4.5	CBC 45 SL
	Ø5.5	CBC 55 SL
	Ø6.5	CBC 65 SL
Bridge	Ø4.5	CBC 45 BL
	Ø5.5	CBC 55 BL
	Ø6.5	CBC 65 BL

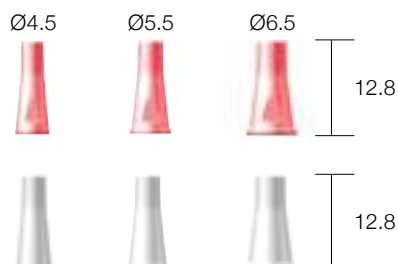

Restorative Kit



Combi & Dual Abutment

Art. No	Lab. Components				
	Comfort Cap	Impression Coping	Analog	Burn-out Cylinder	
XSDAB 45 S	CCC 45 CS	CIC 45 L	CAN 45 SL	CBC 45 SL	CBC 45 BL
XSDAB 45	CCC 45 C		CAN 45 LL		
XSDAB 55 S	CCC 55 CS	CIC 45 L	CAN 55 SL	CBC 55 SL	CBC 55 BL
XSDAB 55	CCC 55 C		CAN 55 LL		
XSDAB 65 S	CCC 65 CS	CIC 45 L	CAN 65 SL	CBC 65 SL	CBC 65 BL
XSDAB 65	CCC 65 C		CAN 65 LL		

Prosthetic Procedure 2

Impression Technique and Restoration Selection

Dual / Custom / Dual Milling / Angled / Direct-Casting / Metal-Casting / Temporary (Plastic & Ti) Abutment

Fixture Level Impression



Analog
 DAN 34 / DANSE
 Page 25, 26



Dual Abutment
 Hex / Non-hex
 Ø4.5 / Ø5.5 / Ø6.5
 Page 20, 21

Custom Abutment
 Hex / Non-hex
 Ø4.5 / Ø5.5
 Page 27

Dual Milling Abutment
 Hex / Non-hex
 Ø4.0 / Ø4.5
 Ø5.5 / Ø6.5 / Ø7.5
 Page 28, 30

Angled Abutment
 Hex / Non-hex
 15° / 25°
 Ø4.5 / Ø5.5
 Page 32, 33, 34, 35

Modification
 |
Cemented Restoration

Direct-Casting Abutment
 Hex / Non-hex
 Ø4.5
 Page 36

Metal-Casting Abutment
 Hex / Non-hex
 Ø4.5
 Page 36

Temporary Abutment
 Hex / Non-hex
 Ø4.5 / Ø5.5 / Ø6.5
 Page 37

Modification
 |
Screw-Retained Restoration

Fixture Level Impression Components

• Impression coping screw is included with Impression coping.

Unit: mm, Scale 1 : 1.5 / mm

Impression Coping Pick-up Ø4.0

Size	Type	Art. No.
Short	Hex	DPU 40 11 HL
Short	Non-hex	DPU 40 11 NL
Long	Hex	DPU 40 15 HL
Long	Non-hex	DPU 40 15 NL

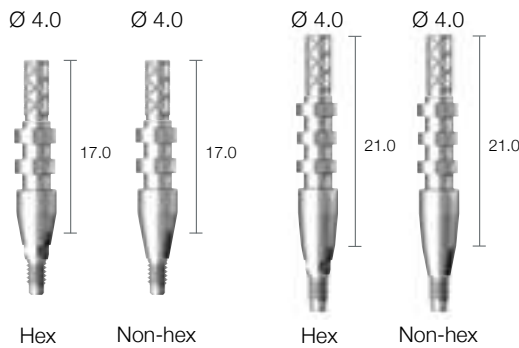

Impression Coping Pick-up Ø4.5

Size	Type	Art. No.
Short	Hex	DPU 45 11 HL
Short	Non-hex	DPU 45 11 NL
Long	Hex	DPU 45 15 HL
Long	Non-hex	DPU 45 15 NL

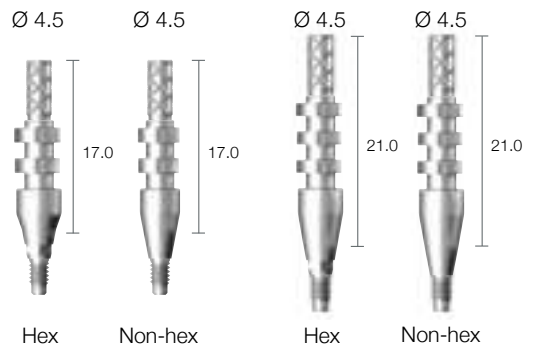

Impression Coping Pick-up Ø5.5

Size	Type	Art. No.
Short	Hex	DPU 55 11 HL
Short	Non-hex	DPU 55 11 NL
Long	Hex	DPU 55 15 HL
Long	Non-hex	DPU 55 15 NL

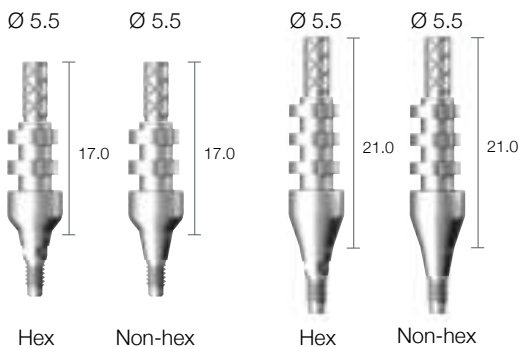

Impression Coping Pick-up Ø6.5

Size	Type	Art. No.
Short	Hex	DPU 65 11 HL
Short	Non-hex	DPU 65 11 NL
Long	Hex	DPU 65 15 HL
Long	Non-hex	DPU 65 15 NL

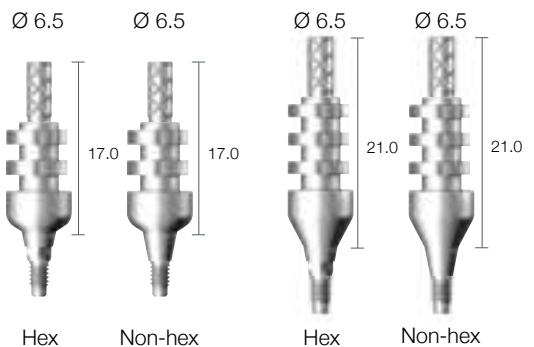

Impression Coping Pick-up Screw

Size	Art. No.
Short	DPS 11
Long	DPS 15

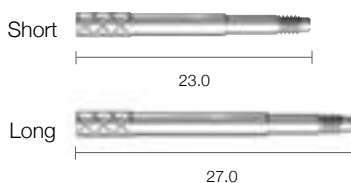

Analogue

Application (BodyØ)	Art. No.
Ø3.4	DAN 34
Ø3.8 / Ø4.3 / Ø4.8 / Ø5.8	DANSE

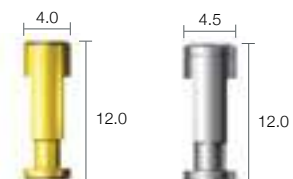

Fixture Level Impression Components

• Impression coping screw is included with Impression coping.

Unit: mm, Scale 1 : 1.5 / mm

Impression Coping Transfer Ø4.0

Size	Type	Art. No.
Short	Hex	DTF 40 11 HL
Short	Non-hex	DTF 40 11 NL
Long	Hex	DTF 40 15 HL
Long	Non-hex	DTF 40 15 NL

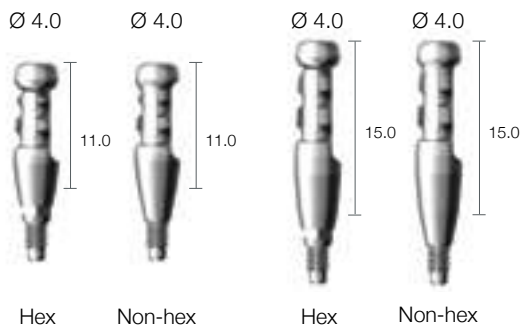

Impression Coping Transfer Ø4.5

Size	Type	Art. No.
Short	Hex	DTF 45 11 HL
Short	Non-hex	DTF 45 11 NL
Long	Hex	DTF 45 15 HL
Long	Non-hex	DTF 45 15 NL

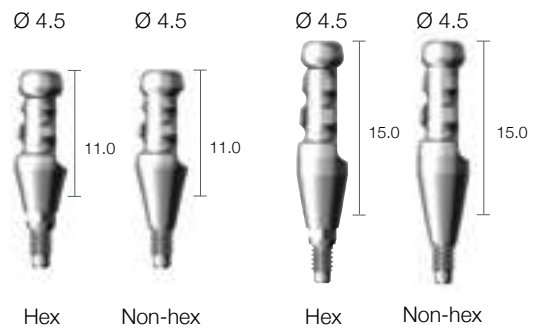

Impression Coping Transfer Ø5.5

Size	Type	Art. No.
Short	Hex	DTF 55 11 HL
Short	Non-hex	DTF 55 11 NL
Long	Hex	DTF 55 15 HL
Long	Non-hex	DTF 55 15 NL

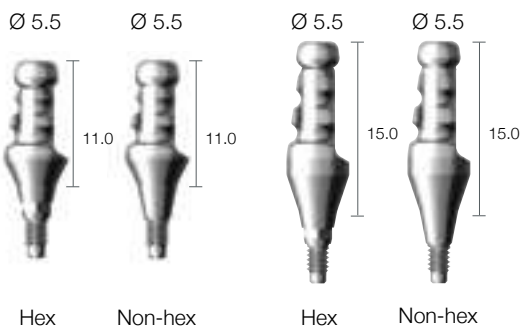

Impression Coping Transfer Ø6.5

Size	Type	Art. No.
Short	Hex	DTF 65 11 HL
Short	Non-hex	DTF 65 11 NL
Long	Hex	DTF 65 15 HL
Long	Non-hex	DTF 65 15 NL

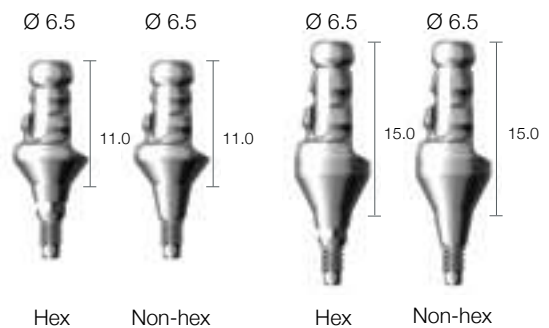

Impression Coping Transfer Screw

Size	Art. No.
Short	DTS 11
Long	DTS 15

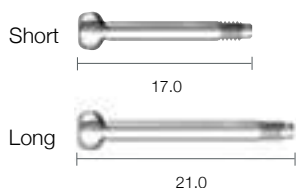

Analogue

Application (BodyØ)	Art. No.
Ø3.4	DAN 34
Ø3.8 / Ø4.3 / Ø4.8 / Ø5.8	DANSE

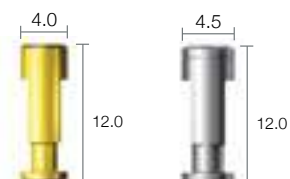

Custom Abutment

- Abutment screw is included.

Unit: mm, Scale 1 : 1.5 / mm

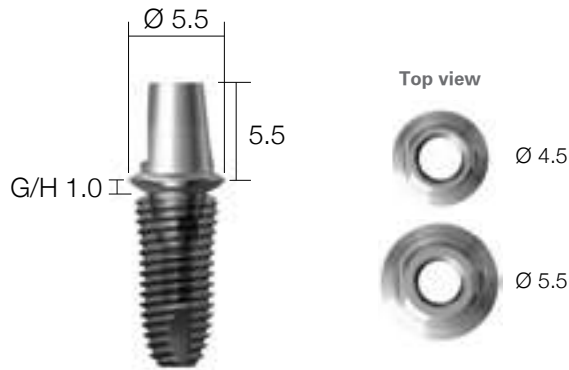

CDAB5510H and FX4510SW

Diameter Ø4.5

G/H	Type	Art. No.
0.5	Hex	CDAB 45 05 H
0.5	Non-hex	CDAB 45 05 N
1.5	Hex	CDAB 45 15 H
1.5	Non-hex	CDAB 45 15 N

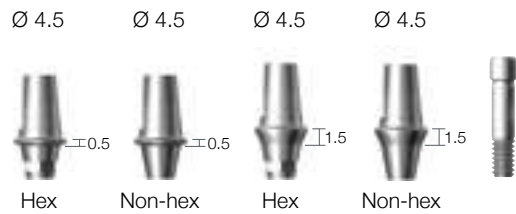

Diameter Ø5.5

G/H	Type	Art. No.
1.0	Hex	CDAB 55 10 H
1.0	Non-hex	CDAB 55 10 N
2.0	Hex	CDAB 55 20 H
2.0	Non-hex	CDAB 55 20 N

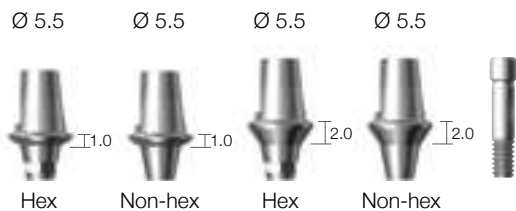

※ Note: 1) If the Implantium fixture with size of Ø3.4 body is used, abutment height after assembly will become 0.5mm longer than other sized fixtures.

2) It is recommended to keep the torque level at 25~30 N·cm to tighten the custom abutment with fixture.

Dual Milling Abutment [Ti-G4]

- Abutment screw is included.

Unit:mm, Scale 1: 1.5 / mm



DAB55157HL and FX4510SW

Diameter Ø4.0

G/H	Type	Art. No.
1.0	Hex	DAB 40 105 HL
1.0	Non-hex	DAB 40 105 NL

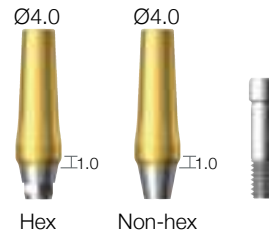

Diameter Ø4.5

G/H	Type	Art. No.
1.5	Hex	DAB 45 156 HL
1.5	Non-hex	DAB 45 156 NL

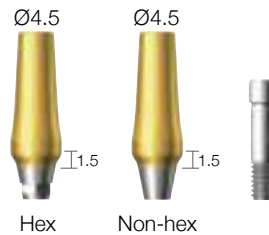

Diameter Ø5.5

G/H	Type	Art. No.
1.5	Hex	DAB 55 157 HL
1.5	Non-hex	DAB 55 157 NL
2.5	Hex	DAB 55 257 HL
2.5	Non-hex	DAB 55 257 NL

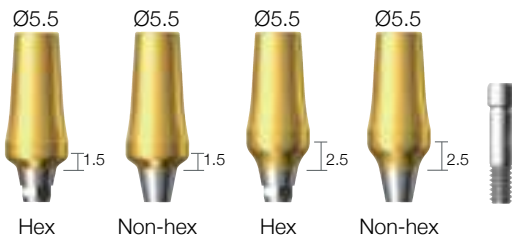

※ Note: 1) If the Implantium fixture with size of Ø3.4 body is used, abutment height after assembly will become 0.5mm longer than other sized fixtures.

2) It is recommended to keep the torque level at 25~30 N·cm to tighten the dual milling abutment with fixture.

Dual Milling Abutment [Ti-G4]

• Abutment screw is included.

Unit:mm, Scale 1: 1.5 / mm

Diameter Ø6.5

G/H	Type	Art. No.
1.5	Hex	DAB 65 158 HL
1.5	Non-hex	DAB 65 158 NL
2.5	Hex	DAB 65 258 HL
2.5	Non-hex	DAB 65 258 NL
3.5	Hex	DAB 65 358 HL
3.5	Non-hex	DAB 65 358 NL

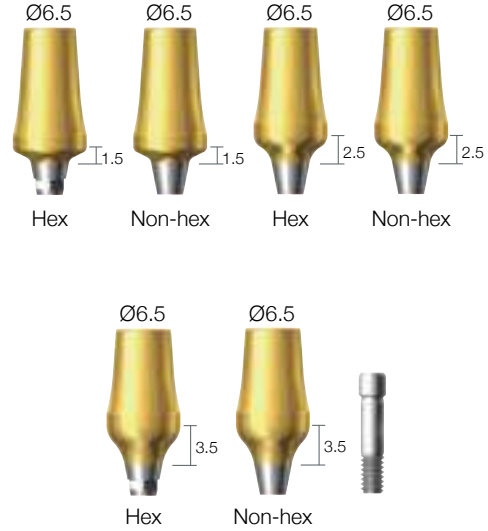

Diameter Ø7.5

G/H	Type	Art. No.
2.5	Hex	DAB 75 259 HL
2.5	Non-hex	DAB 75 259 NL
3.5	Hex	DAB 75 359 HL
3.5	Non-hex	DAB 75 359 NL

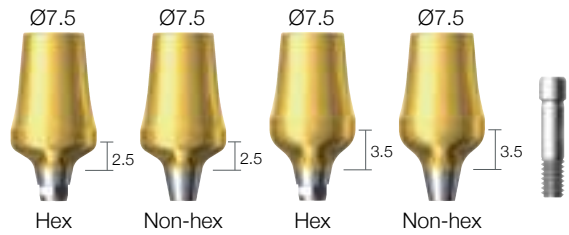

※ Note: 1) If the Implantium fixture with size of Ø3.4 body is used, abutment height after assembly will become 0.5mm longer than other sized fixtures.

2) It is recommended to keep the torque level at 25~30 N·cm to tighten the dual milling abutment with fixture.

Dual Milling Abutment [Ti-G2]

- Abutment screw is included.

Unit: mm, Scale 1 : 1.5 / mm



DAB55157HG and FX4510SW

Diameter Ø4.0

G/H	Type	Art. No.
1.0	Hex	DAB 40 105 HG
1.0	Non-hex	DAB 40 105 NG

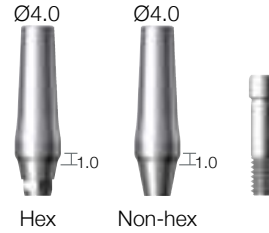

Diameter Ø4.5

G/H	Type	Art. No.
1.5	Hex	DAB 45 156 HG
1.5	Non-hex	DAB 45 156 NG

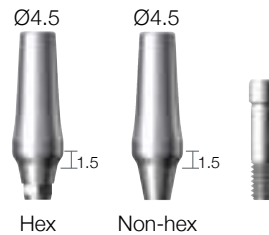

Diameter Ø5.5

G/H	Type	Art. No.
1.5	Hex	DAB 55 157 HG
1.5	Non-hex	DAB 55 157 NG
2.5	Hex	DAB 55 257 HG
2.5	Non-hex	DAB 55 257 NG

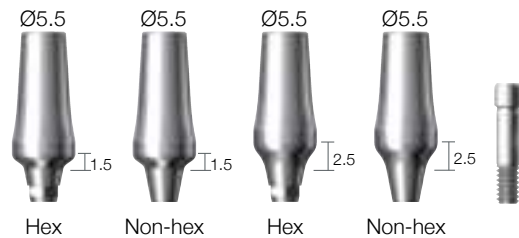

※ Note: 1) If the Implantium fixture with size of Ø3.4 body is used, abutment height after assembly will become 0.5mm longer than other sized fixtures.

2) It is recommended to keep the torque level at 25~30 N·cm to tighten the dual milling abutment with fixture.

Dual Milling Abutment [Ti-G2]

• Abutment screw is included.

Unit: mm, Scale 1 : 1.5 / mm

Diameter Ø6.5

G/H	Type	Art. No.
1.5	Hex	DAB 65 158 HG
1.5	Non-hex	DAB 65 158 NG
2.5	Hex	DAB 65 258 HG
2.5	Non-hex	DAB 65 258 NG
3.5	Hex	DAB 65 358 HG
3.5	Non-hex	DAB 65 358 NG

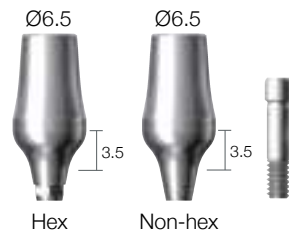

Diameter Ø7.5

G/H	Type	Art. No.
2.5	Hex	DAB 75 259 HG
2.5	Non-hex	DAB 75 259 NG
3.5	Hex	DAB 75 359 HG
3.5	Non-hex	DAB 75 359 NG



※ Note: 1) If the Implantium fixture with size of Ø3.4 body is used, abutment height after assembly will become 0.5mm longer than other sized fixtures.

2) It is recommended to keep the torque level at 25~30 N·cm to tighten the dual milling abutment with fixture.

Angled Abutment [Ti-G4 / 15°]

- Abutment screw is included.

Unit: mm, Scale 1 : 1.5 / mm

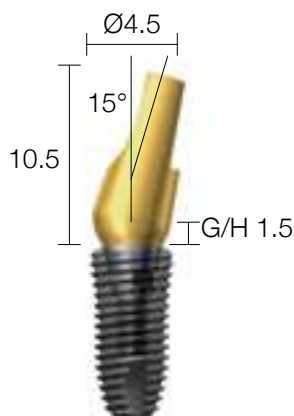

AAB154515HL and FX4510SW

Diameter Ø4.5 | Angled 15°

G/H	Type	Art. No.
1.5	Hex	AAB 15 45 15 HL
1.5	Non-hex	AAB 15 45 15 NL
2.5	Hex	AAB 15 45 25 HL
2.5	Non-hex	AAB 15 45 25 NL
3.5	Hex	AAB 15 45 35 HL
3.5	Non-hex	AAB 15 45 35 NL

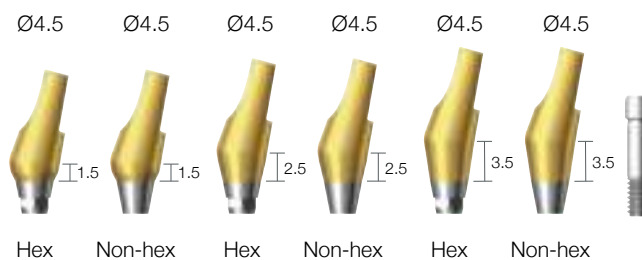

Diameter Ø5.5 | Angled 15°

G/H	Type	Art. No.
1.5	Hex	AAB 15 55 15 HL
1.5	Non-hex	AAB 15 55 15 NL
2.5	Hex	AAB 15 55 25 HL
2.5	Non-hex	AAB 15 55 25 NL
3.5	Hex	AAB 15 55 35 HL
3.5	Non-hex	AAB 15 55 35 NL

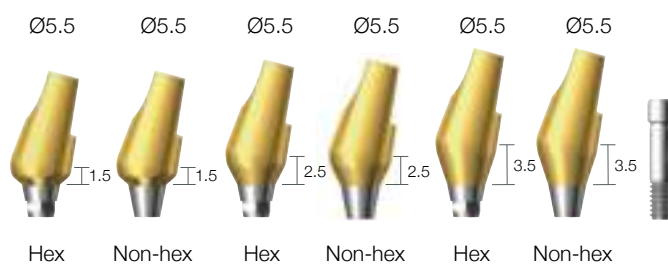

※ Note: 1) If the Implantium fixture with size of Ø3.4 body is used, abutment height after assembly will become 0.5mm longer than other sized fixtures.

2) It is recommended to keep the torque level at 25~30 N·cm to tighten the angled abutment with fixture.

Angled Abutment [Ti-G4 / 25°]

• Abutment screw is included.

Unit: mm, Scale 1 : 1.5 / mm

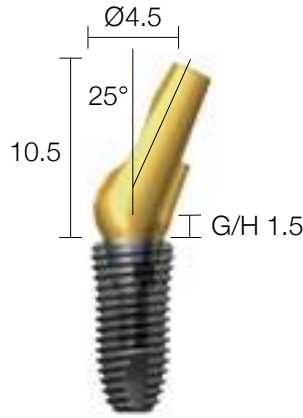

AAB254515HL and FX4510SW

Diameter Ø4.5 | Angled 25°

G/H	Type	Art. No.
1.5	Hex	AAB 25 45 15 HL
1.5	Non-hex	AAB 25 45 15 NL
2.5	Hex	AAB 25 45 25 HL
2.5	Non-hex	AAB 25 45 25 NL
3.5	Hex	AAB 25 45 35 HL
3.5	Non-hex	AAB 25 45 35 NL

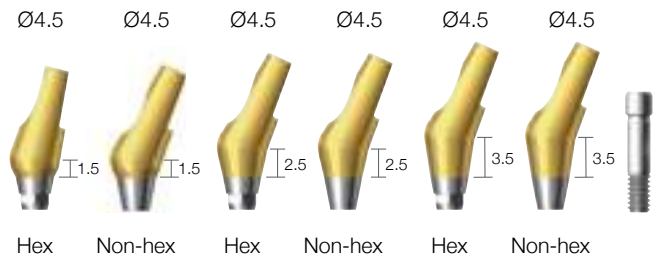

Diameter Ø5.5 | Angled 25°

G/H	Type	Art. No.
1.5	Hex	AAB 25 55 15 HL
1.5	Non-hex	AAB 25 55 15 NL
2.5	Hex	AAB 25 55 25 HL
2.5	Non-hex	AAB 25 55 25 NL
3.5	Hex	AAB 25 55 35 HL
3.5	Non-hex	AAB 25 55 35 NL

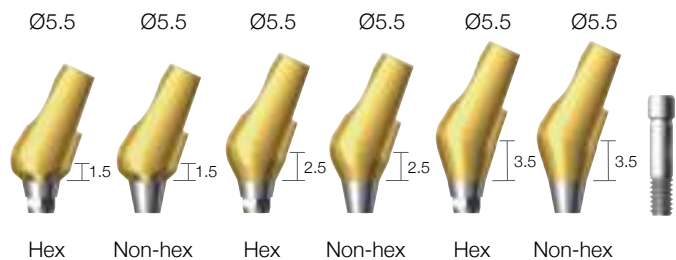

※ Note: 1) If the Implantium fixture with size of Ø3.4 body is used, abutment height after assembly will become 0.5mm longer than other sized fixtures.

2) It is recommended to keep the torque level at 25~30 N·cm to tighten the angled abutment with fixture.

Angled Abutment [Ti-G2 / 15°]

- Abutment screw is included.

Unit: mm, Scale 1 : 1.5 / mm

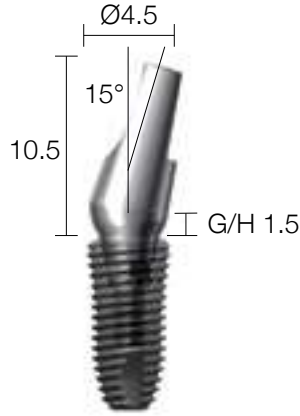

AAB154515HG and FX4510SW

Diameter Ø4.5 | Angled 15°

G/H	Type	Art. No.
1.5	Hex	AAB 15 45 15 HG
1.5	Non-hex	AAB 15 45 15 NG
2.5	Hex	AAB 15 45 25 HG
2.5	Non-hex	AAB 15 45 25 NG
3.5	Hex	AAB 15 45 35 HG
3.5	Non-hex	AAB 15 45 35 NG

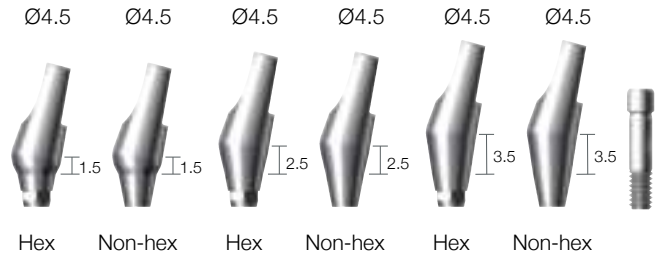

Diameter Ø5.5 | Angled 15°

G/H	Type	Art. No.
1.5	Hex	AAB 15 55 15 HG
1.5	Non-hex	AAB 15 55 15 NG
2.5	Hex	AAB 15 55 25 HG
2.5	Non-hex	AAB 15 55 25 NG
3.5	Hex	AAB 15 55 35 HG
3.5	Non-hex	AAB 15 55 35 NG

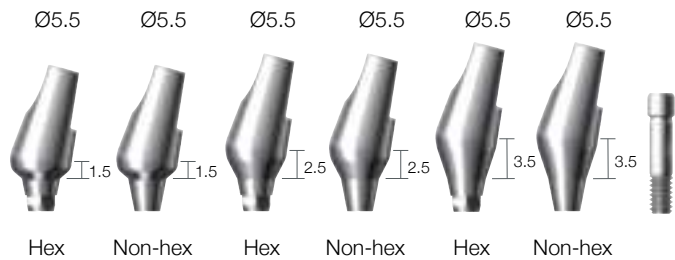

※ Note: 1) If the Implantium fixture with size of Ø3.4 body is used, abutment height after assembly will become 0.5mm longer than other sized fixtures.

2) It is recommended to keep the torque level at 25~30 N·cm to tighten the angled abutment with fixture.

Angled Abutment [Ti-G2 / 25°]

- Abutment screw is included.

Unit: mm, Scale 1 : 1.5 / mm

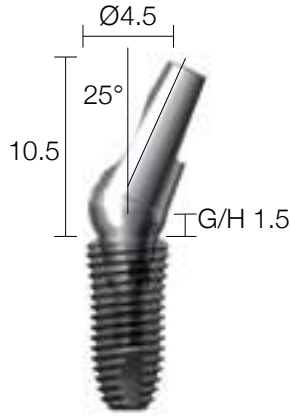

AAB254515HG and FX4510SW

Diameter Ø4.5 | Angled 25°

G/H	Type	Art. No.
1.5	Hex	AAB 25 45 15 HG
1.5	Non-hex	AAB 25 45 15 NG
2.5	Hex	AAB 25 45 25 HG
2.5	Non-hex	AAB 25 45 25 NG
3.5	Hex	AAB 25 45 35 HG
3.5	Non-hex	AAB 25 45 35 NG

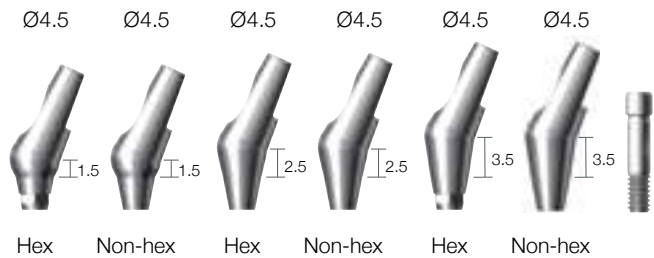

Diameter Ø5.5 | Angled 25°

G/H	Type	Art. No.
1.5	Hex	AAB 25 55 15 HG
1.5	Non-hex	AAB 25 55 15 NG
2.5	Hex	AAB 25 55 25 HG
2.5	Non-hex	AAB 25 55 25 NG
3.5	Hex	AAB 25 55 35 HG
3.5	Non-hex	AAB 25 55 35 NG

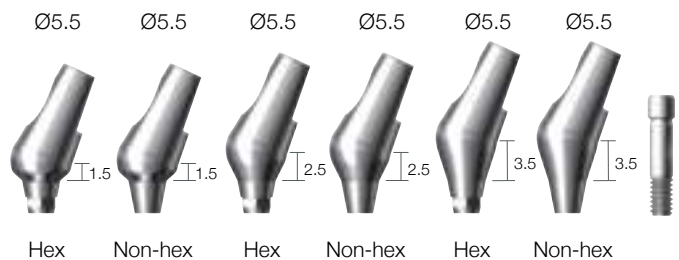

※ Note: 1) If the Implantium fixture with size of Ø3.4 body is used, abutment height after assembly will become 0.5mm longer than other sized fixtures.

2) It is recommended to keep the torque level at 25~30 N·cm to tighten the angled abutment with fixture.

Direct-Casting Abutment / Metal-Casing Abutment

• Abutment screw is included.

Unit: mm, Scale 1 : 1.5 / mm

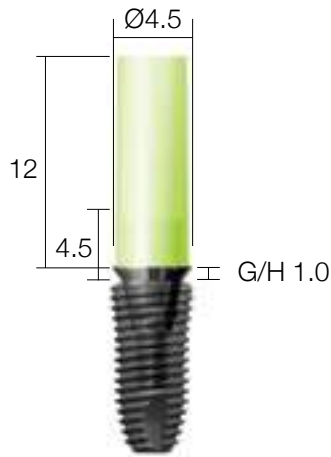

RAB45GH and FX4510SW



RAB45CH and FX4510SW

Direct-Casting Abutment | Gold

G/H	Type	Art. No.
1.0	Hex	RAB 45 GH
1.0	Non-hex	RAB 45 GN

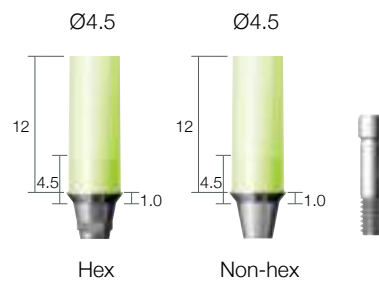

Metal-Casting Abutment | Co-Cr

G/H	Type	Art. No.
1.0	Hex	RAB 45 CH
1.0	Non-hex	RAB 45 CN

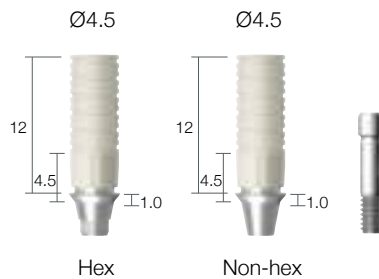

※ Note: 1) If the Implantium fixture with size of Ø3.4 body is used, abutment height after assembly will become 0.5mm longer than other sized fixtures.

2) It is recommended to keep the torque level at 25~30 N·cm to tighten the direct-casting / metal-casing abutment with fixture.

Temporary Abutment

- Abutment screw is included.

Unit: mm, Scale 1 : 1.5 / mm

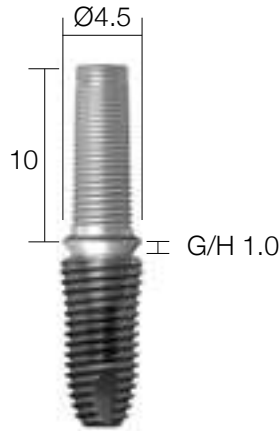

RAB45THG and FX4510SW



RAB4520PHL and FX4510SW

Ti-Temporary Abutment

Diameter	G/H	Type	Art. No.
Ø4.5	1.0	Hex	RAB 45 THG
Ø4.5	1.0	Non-hex	RAB 45 TNG

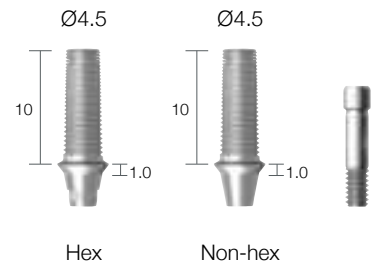

Plastic Temporary Abutment

Diameter	G/H	Type	Art. No.
Ø4.5	2.0	hex	RAB 45 20 PHL
Ø4.5	2.0	Non-hex	RAB 45 20 PNL
Ø5.5	2.0	hex	RAB 55 20 PHL
Ø5.5	2.0	Non-hex	RAB 55 20 PNL
Ø6.5	2.0	hex	RAB 65 20 PHL
Ø6.5	2.0	Non-hex	RAB 65 20 PNL

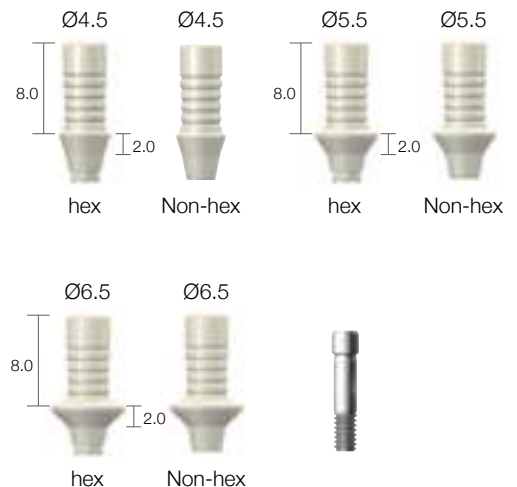

※ Note: 1) If the Implantium fixture with size of Ø3.4 body is used, abutment height after assembly will become 0.5mm longer than other sized fixtures.

2) It is recommended to keep the torque level at 25~30 N·cm to tighten the temporary abutment with fixture.

Prosthetic Procedure 3

Impression Technique and Restoration Selection

Screw Abutment

Abutment Level Impression



Screw Abutment
Ø4.5 / Ø5.5

Page 39



Angled Screw Abutment
Ø4.5 / Ø5.5

Page 40

Open Tray Technique



Impression Coping Pick-up

Bridge / Single Ø4.5 / Ø5.5

Page 41

Closed Tray Technique



Impression Coping Transfer

Bridge / Single Ø4.5 / Ø5.5

Page 41

Analog

Ø4.5/Ø5.5

Page 42



Burn-out Cylinder

Ø4.5 / Ø5.5

Page 43



Gold Cylinder

Ø4.5 / Ø5.5

Page 43



Metal Cylinder

Ø4.5 / Ø5.5

Page 43



Titanium Cylinder

Ø4.5 / Ø5.5

Page 43



Bridge
(Non-hex)

Single
(Hex)

Bridge
(Non-hex)

Single
(Hex)

Bridge
(Non-hex)

Single
(Hex)

Bridge
(Non-hex)

Single
(Hex)

Polishing Protector

Ø4.5 / Ø5.5

Page 42



Temporary Restoration



Ti-Retaining Screw

Page 42

Screw-Retained Restoration

Screw Abutment

Unit: mm, Scale 1 : 1.5 / mm



Delivery Holder



SAB5535L and FX4510SW

Diameter Ø4.5

G/H	Art. No.
1.0	SAB45 10 L
1.5	SAB45 15 L
2.5	SAB45 25 L
3.5	SAB45 35 L
4.5	SAB45 45 L
5.5	SAB45 55 L

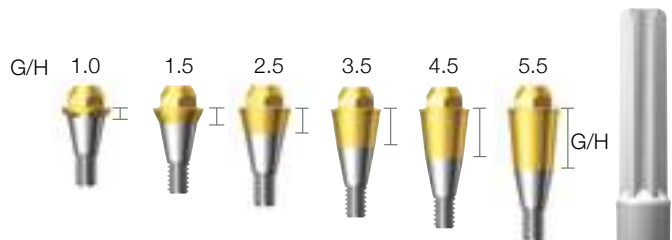

Diameter Ø5.5

G/H	Art. No.
1.5	SAB55 15 L
2.5	SAB55 25 L
3.5	SAB55 35 L
4.5	SAB55 45 L
5.5	SAB55 55 L

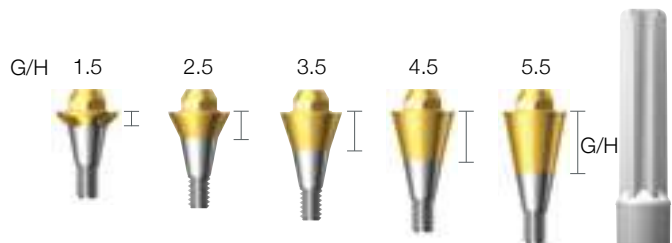

※ Note: 1) The Implantium fixture with size of Ø3.4 body is not recommended to use with the screw abutment. Should they be used together, abutment height after assembly will become 0.5mm longer than the other sized fixtures.
 2) It is recommended to keep the torque level at 25~30 N·cm to tighten the screw abutment with fixture.

Angled Screw Abutment

Unit: mm, Scale 1 : 1.5 / mm



ASA55151518N and FX4510SW



ASA55301518N and FX4510SW



Delivery Holder

Angled Screw Abutment Ø4.5

G/H	Type	Art. No.
1.0	Hex	ASA 45 15 10 18 H
1.0	Non-hex	ASA 45 15 10 18 N
1.0	Hex	ASA 45 30 10 18 H
1.0	Non-hex	ASA 45 30 10 18 N

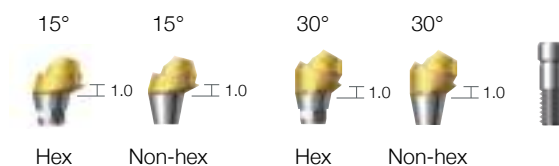

Angled Screw Abutment Ø5.5

G/H	Type	Art. No.
1.5	Hex	ASA 55 15 15 18 H
1.5	Non-hex	ASA 55 15 15 18 N
1.5	Hex	ASA 55 30 15 18 H
1.5	Non-hex	ASA 55 30 15 18 N

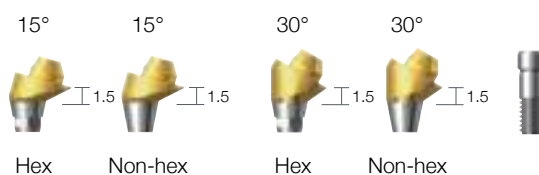

Angled Screw Abutment Screw

ASASC 20 23

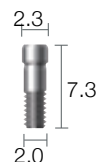

※ Note: 1) The Implantium fixture with size of Ø3.4 body is not recommended to use with the screw abutment. Should they be used together, abutment height after assembly will become 0.5mm longer than the other sized fixtures.
 2) It is recommended to keep the torque level at 25~30 N·cm to tighten the screw abutment with fixture.

Screw Abutment Impression Components

Unit: mm, Scale 1 : 1.5 / mm

Impression Coping Pick-up

Diameter	Type		Art. No.
Ø4.5	Single	Hex	SPU 45 SL
Ø4.5	Bridge	Non-hex	SPU 45 BL
Ø5.5	Single	Hex	SPU 55 SL
Ø5.5	Bridge	Non-hex	SPU 55 BL

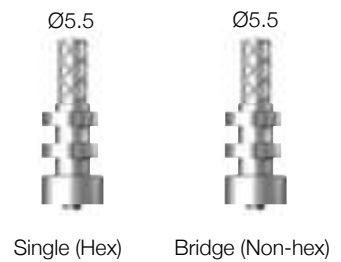
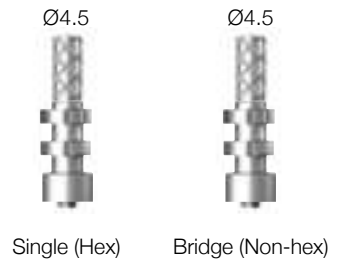

Impression Coping Transfer

Diameter	Type		Art. No.
Ø4.5	Single	Hex	STF 45 SL
Ø4.5	Bridge	Non-hex	STF 45 BL
Ø5.5	Single	Hex	STF 55 SL
Ø5.5	Bridge	Non-hex	STF 55 BL

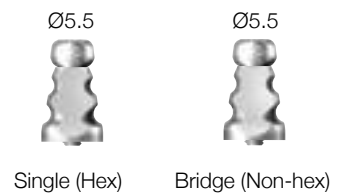
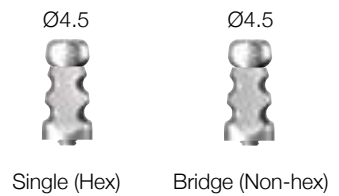

Impression Coping Screw

Type	Art. No.
Pick-up	SPS 09
Transfer	STS 09

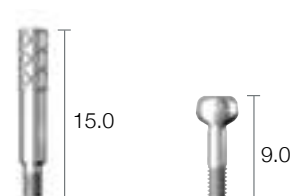

Screw Abutment Impression Components

Unit: mm, Scale 1 : 1.5 / mm

Comfort Cap

Diameter	Art. No.
Ø4.5	SCC 45 L
Ø5.5	SCC 55 L



Analog

Diameter	Art. No.
Ø4.5	SAN 45 L
Ø5.5	SAN 55 L

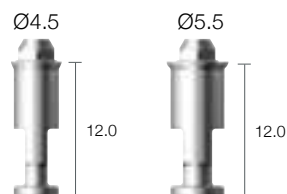

Polishing Protector

Diameter	Art. No.
Ø4.5	SPP 45 L
Ø5.5	SPP 55 L



Ti-Retaining Screw

SRS 18 T



Ti-Cylinder

Diameter	Type		Art. No.
Ø4.5	Single	Hex	STC 45 SG
Ø4.5	Bridge	Non-hex	STC 45 BG
Ø5.5	Single	Hex	STC 55 SG
Ø5.5	Bridge	Non-hex	STC 55 BG

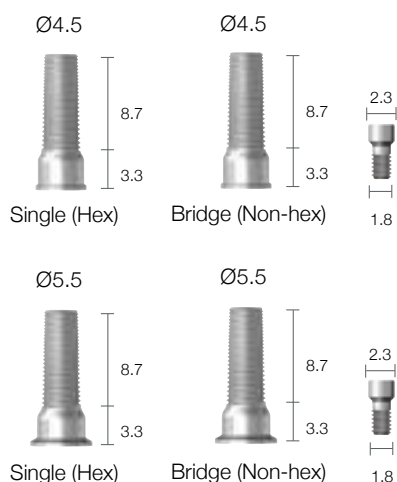

Screw Abutment Impression Components

Unit: mm, Scale 1 : 1.5 / mm

Gold Cylinder

Diameter	Type		Art. No.
Ø4.5	Single	Hex	SGC 45 SL
Ø4.5	Bridge	Non-hex	SGC 45 BL
Ø5.5	Single	Hex	SGC 55 SL
Ø5.5	Bridge	Non-hex	SGC 55 BL

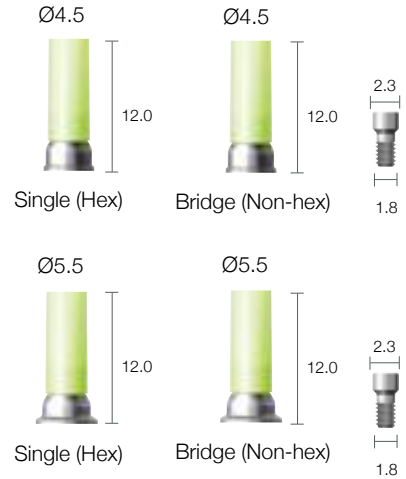

Metal Cylinder | Co-Cr

Diameter	Type		Art. No.
Ø4.5	Single	Hex	SGC 45 CSL
Ø4.5	Bridge	Non-hex	SGC 45 CBL
Ø5.5	Single	Hex	SGC 55 CSL
Ø5.5	Bridge	Non-hex	SGC 55 CBL

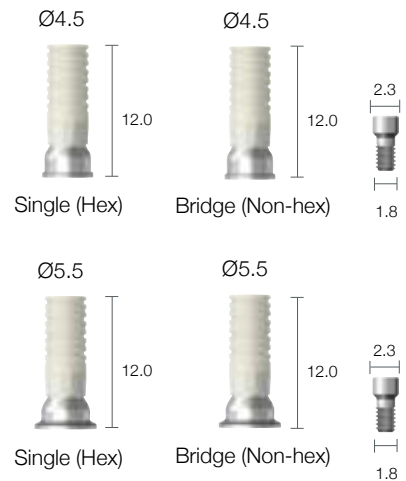

Burn-out Cylinder

Diameter	Type		Art. No.
Ø4.5	Single	Hex	SBC 45 SL
Ø4.5	Bridge	Non-hex	SBC 45 BL
Ø5.5	Single	Hex	SBC 55 SL
Ø5.5	Bridge	Non-hex	SBC 55 BL

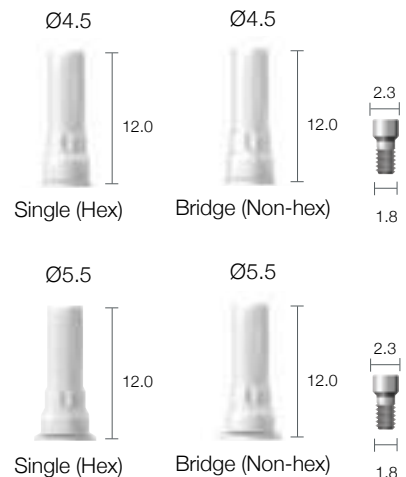

Prosthetic Procedure 4

Impression Technique and Restoration Type

Overdenture Procedure

Positioner / Mini Ball / Magnetic Attachment

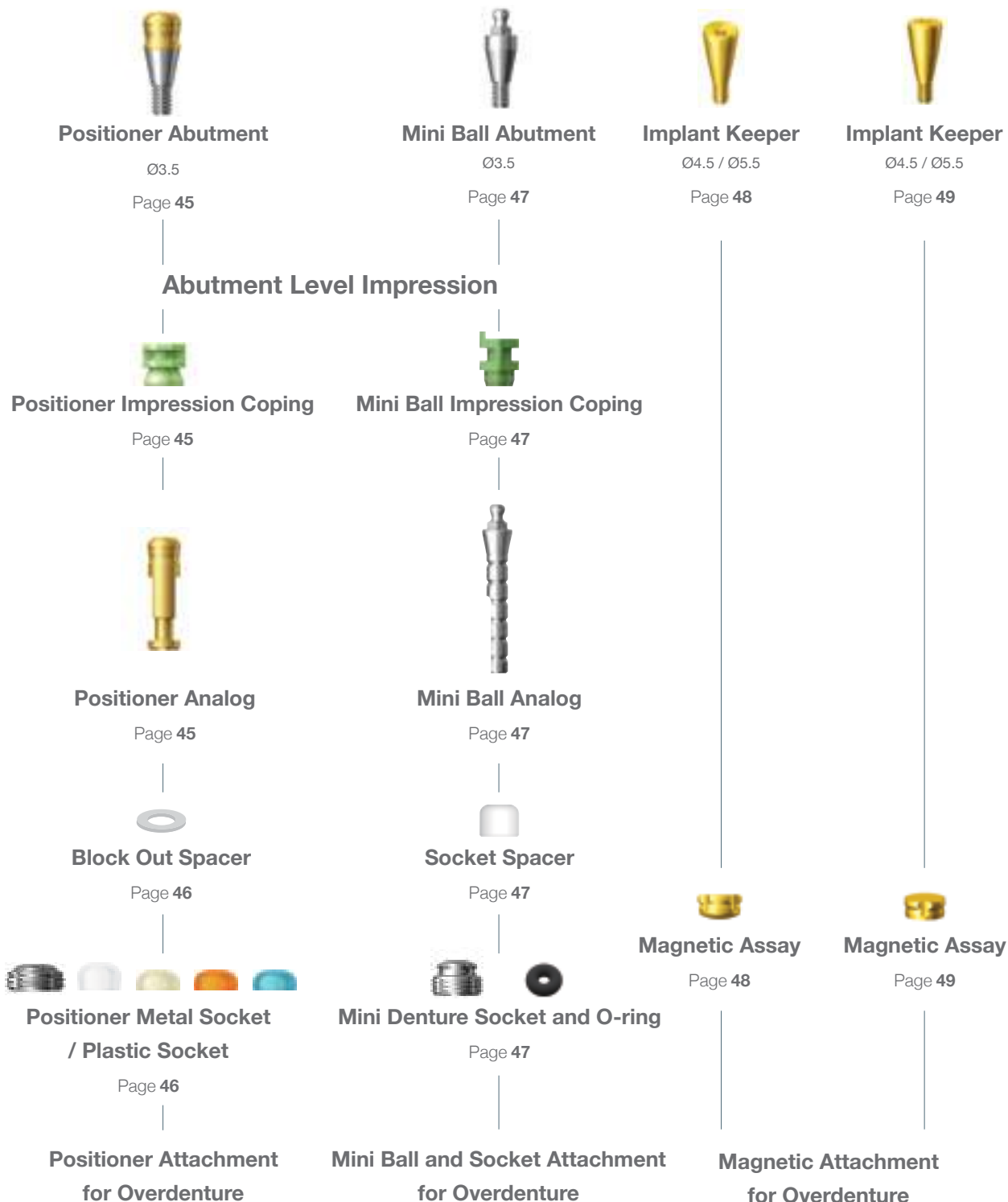

Positioner

- For multiple-unit and full-arch restorations
- Self Aligning : Self aligning mechanism allows easy and convenient denture placement
- Tilting Angle : Tilting Type ($\pm 10^\circ$) / Non Tilting Type ($\pm 5^\circ$)
- Four Different Retention Options : 100gf, 300gf, 500gf and 1,000gf



Process to make overdenture using the Positioner

1. Non-tilting plastic socket having $\pm 5^\circ$ is recommended as a standard assembly
2. Make denture based on the white plastic socket having 100gf
3. If the path is not parallel (more than $\pm 5^\circ$), use the Tilting Type plastic socket having $\pm 10^\circ$
4. Select and use the plastic socket (300gf, 500gf, or 1,000gf) based on the desired retention force for the patient

Mini Ball Attachment

Tilting Angle



Up to +15 degrees of angle tilting freedom for pathway of implant.

Mini Ball

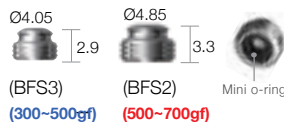

- Mini ball size ($\text{Ø}1.8$)
- Mini o-ring type female socket
- Minimal-size female socket
- Mini o-ring are replacable



Magnetic Attachment

- Designed to stand lateral force
- Compensate path ($\pm 20^\circ$)
- Favorable for denture by low height(2.0mm) attachment

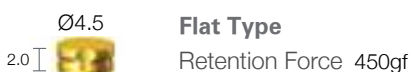
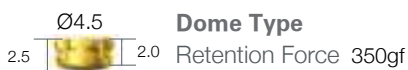

Positioner

Unit:mm, Scale 1: 1.5 / mm



FSMH and PAB3520 and FX4510SW

Positioner Abutment

G/H	Art. No.
1.0	PAB 35 10
2.0	PAB 35 20
3.0	PAB 35 30
4.0	PAB 35 40
5.0	PAB 35 50
6.0	PAB 35 60
7.0	PAB 35 70

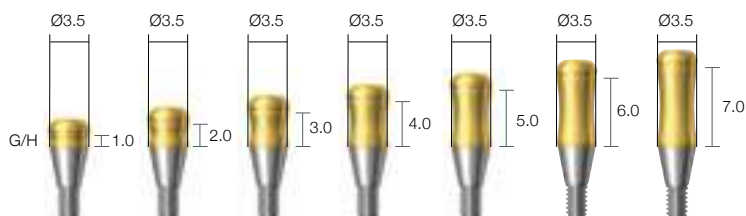

Positioner Impression Coping

PIC



Positioner Analog

PAN



※ Note: 1) The Implantium fixture with size of $\text{Ø}3.4$ body is not recommended to use with the positioner abutment. Should they be used together, abutment height after assembly will become 0.5mm longer than the other sized fixtures.
 2) It is recommended to keep the torque level at 25~30 N·cm to tighten the ball abutment with fixture.

Positioner

Unit:mm, Scale 1: 1.5 / mm

Positioner Socket Set

Art. No.	FSMHS(Tilting Type $\pm 10^\circ$)
	FSMHSN(Non Tilting Type $\pm 5^\circ$)

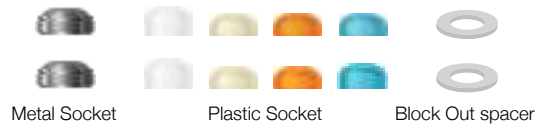

Positioner Metal Socket

Art. No.	FSMH
----------	------



Positioner Plastic Socket

Application	Art. No.
Tilting Type $\pm 10^\circ$	MSHP (Blue)
	MSMP (Orange)
	MSLP (Ivory)
	MSOP (White)
Non Tilting Type $\pm 5^\circ$	MSHPN (Blue)
	MSMPN (Orange)
	MSLPN (Ivory)
	MSOP (White)

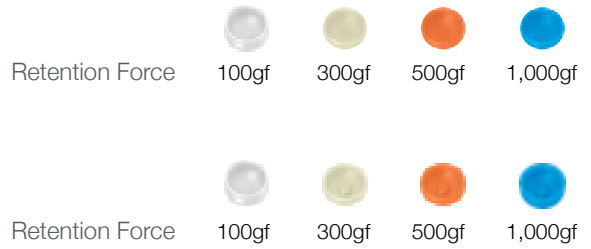

Positioner Block Out Spacer

Art. No.	PBOS
----------	------

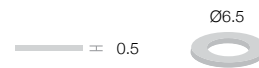

Positioner Core Tool

Art. No.	XPCT
----------	------



Mini Ball Attachment

Unit:mm, Scale 1: 1.5 / mm



BPF3 and BAB352018 and FX4510SW

Mini Ball Abutment

G/H	Art. No.
0	BAB 35 00 18
1.0	BAB 35 10 18
2.0	BAB 35 20 18
3.0	BAB 35 30 18
4.0	BAB 35 40 18
5.0	BAB 35 50 18

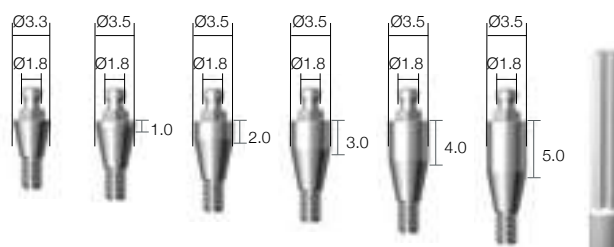

Mini Ball Impression Coping

ICA



Mini Ball Analog

BANL



Socket Spacer

Art. No.	BIC3L
----------	-------



Female Socket

Art. No.	BPF3 (300~500gf) BPF2 (500~700gf)
----------	--------------------------------------

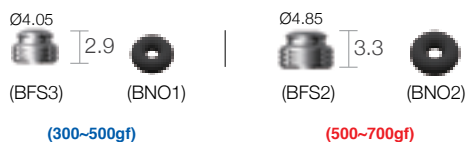

※ Note: 1) The Implantium fixture with size of Ø3.4 body is not recommended to use with the ball abutment. Should they be used together, abutment height after assembly will become 0.5mm longer than the other sized fixtures.
 2) It is recommended to keep the torque level at 25~30 N·cm to tighten the ball abutment with fixture.

Magnetic Attachment [Dome Type]

Unit:mm, Scale 1: 1.5 / mm

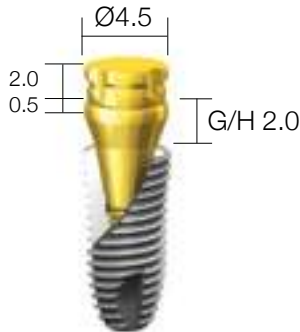

MGT4520D and MKP4520D and FX4510SW

Magnetic Assay

Application	Diameter	H	Art. No.
MKP45D	Ø4.5	2.0	MGT 45 20 D
MKP55D	Ø5.5	2.0	MGT 55 20 D



Implant Keeper Diameter Ø4.5

G/H	Art. No.
1.0	MKP 45 10 D
2.0	MKP 45 20 D
3.0	MKP 45 30 D
4.0	MKP 45 40 D
5.0	MKP 45 50 D
6.0	MKP 45 60 D



Implant Keeper Diameter Ø5.5

G/H	Art. No.
1.0	MKP 55 10 D
2.0	MKP 55 20 D
3.0	MKP 55 30 D
4.0	MKP 55 40 D
5.0	MKP 55 50 D
6.0	MKP 55 60 D

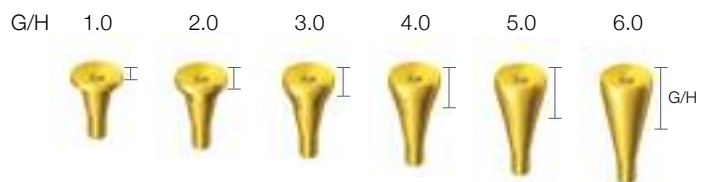

※ Note: 1) The Implantium fixture with size of Ø3.4 body is not recommended to use with the magnetic abutment. Should they be used together, abutment height after assembly will become 0.5mm longer than the other sized fixtures.
 2) It is recommended to keep the torque level at 25~30 N·cm to tighten the magnetic abutment with fixture.

Magnetic Attachment [Flat Type]

Unit:mm, Scale 1: 1.5 / mm



MGT4515 and MKP4520 and FX4510SW

Magnetic Assay

Application	Diameter	H	Art. No.
MKP45	Ø4.5	1.5	MGT 45 15
MKP45	Ø4.5	2.0	MGT 45 20
MKP55	Ø5.5	1.5	MGT 55 15
MKP55	Ø5.5	2.0	MGT 55 20

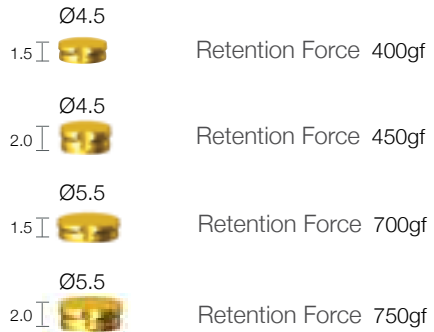

Implant Keeper Diameter Ø4.5

G/H	Art. No.
1.0	MKP 45 10
2.0	MKP 45 20
3.0	MKP 45 30
4.0	MKP 45 40
5.0	MKP 45 50
6.0	MKP 45 60



Implant Keeper Diameter Ø5.5

G/H	Art. No.
1.0	MKP 55 10
2.0	MKP 55 20
3.0	MKP 55 30
4.0	MKP 55 40
5.0	MKP 55 50
6.0	MKP 55 60



※ Note: 1) The Implantium fixture with size of Ø3.4 body is not recommended to use with the magnetic abutment. Should they be used together, abutment height after assembly will become 0.5mm longer than the other sized fixtures.
 2) It is recommended to keep the torque level at 25~30 N·cm to tighten the magnetic abutment with fixture.





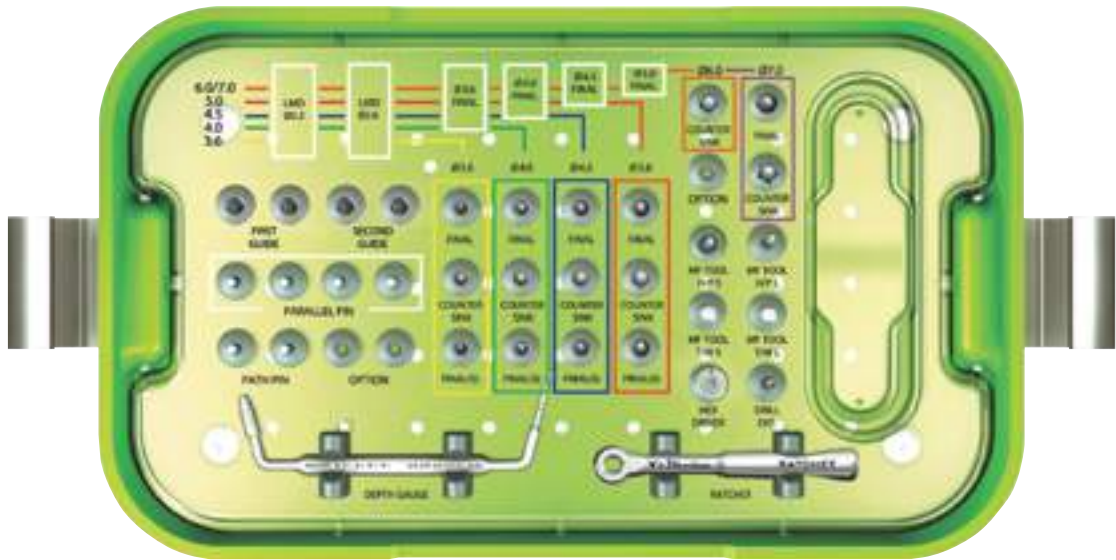









Surgical Kit [Full]

Unit:mm, Scale 1: 1.5 / mm



UXIF

Kit Contents

- | | | | | | |
|-------------------------|---|----------------------------|----------------------|---|-----------------|
| • First guide drill |  | XLD 22 29 | • Parallel pin x4 |  | XPP 162220 T |
| |  | XLD 22 35 (Stopper) | | | |
| • Second guide drill |  | XLD 26 29 | • Hand-piece adapter |  | XID 27 H |
| |  | XLD 26 35 (Stopper) | |  | XID 32 H |
| • Final drill (Stopper) |  | XFD 34 35 | • Ratchet adapter |  | XID 26 W |
| |  | XFD 38 35 | |  | XID 32 W |
| |  | XFD 43 35 | • Path pin x2 |  | XMFPA2 |
| |  | XFD 48 35 | • Hex driver |  | XHD 26 T |
| • Final drill |  | XFD 34 29 | • Drill extension |  | XDE |
| |  | XFD 38 29 | | | |
| |  | XFD 43 29 | • Depth gauge |  | XDGL |
| |  | XFD 48 29 | | | |
| |  | XFD 58 31 | • Ratchet |  | XRCA1 |
| • Countersink |  | XCS 36 29 SW | | | |
| |  | XCS 40 29 SW | | | |
| |  | XCS 45 29 SW | | | |
| |  | XCS 50 29 SW | | | |
| |  | XCS 60 29 SW | | | |
| |  | XCS 70 29 SW | | | |























Surgical Kit [Standard]

Unit:mm, Scale 1: 1.5 / mm



UXIFN

Kit Contents

- | | | | | | |
|----------------------|---|--------------|----------------------|---|--------------|
| • First guide drill |  | XLD 22 31 | • Parallel pin |  | XPP 162220 T |
| • Second guide drill |  | XLD 26 31 | |  | XPP 162226 T |
| • Final drill |  | XFD 34 31 | • Hand-piece adapter |  | XID 30 H |
| |  | XFD 38 31 | • Ratchet adapter |  | XID 26 W |
| |  | XFD 43 31 | • MF path pin x2 |  | XMFPA2 |
| |  | XFD 48 31 | • Hex driver |  | XHD 26 T |
| |  | XFD 58 31 | |  | XHD 25 H |
| • Countersink |  | XCS 36 29 SW | • Drill extension |  | XDE |
| |  | XCS 40 29 SW | • Ratchet |  | XRCA1 |
| |  | XCS 45 29 SW | | | |
| |  | XCS 50 29 SW | | | |
| |  | XCS 60 29 SW | | | |
| |  | XCS 70 29 SW | | | |





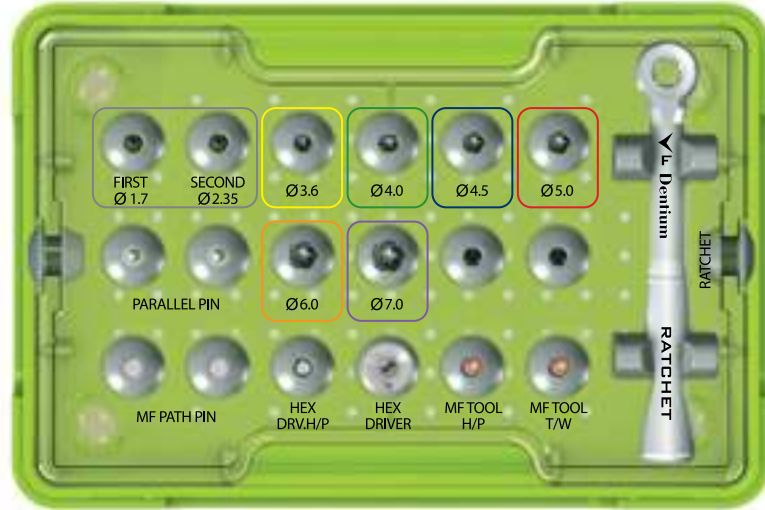









Surgical Kit [Short Implant]

Unit:mm, Scale 1: 1.5 / mm



XSIK

Kit Contents

- | | | | | | |
|----------------------|---|------------------|----------------------|---|-----------------|
| • First guide drill |  | XLD 22 07 | • Parallel pin × 2 |  | XPP 162212 |
| • Second guide drill |  | XLD 26 07 | • Hand-piece adapter |  | XID 27 H |
| • Final drill |  | XFC 36 07 | • Ratchet adapter |  | XID 26 W |
| |  | XFC 40 07 | • MF path pin x2 |  | XMFPA2 |
| |  | XFC 45 07 | • Hex driver |  | XHD 26 T |
| |  | XFC 50 07 | |  | XHD 25 H |
| |  | XFC 60 07 | | | |
| |  | XFC 70 07 | • Ratchet |  | XRCA1 |

Drill Stopper Kit

Unit:mm, Scale 1: 1.5 / mm

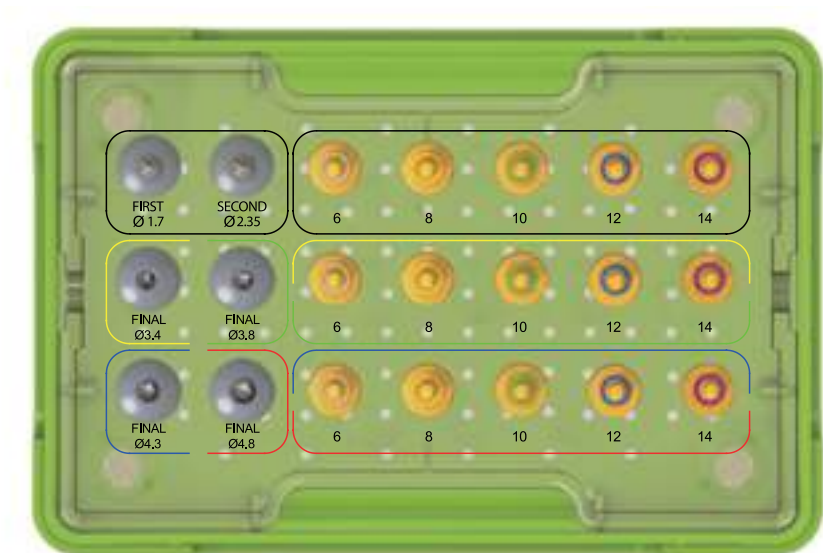

XDS

Kit Contents

- Guide drill stopper / First, Second



- Final drill stopper / 34, 38



- Final drill stopper / 43, 48



- Stopper-first guide drill, second guide drill



- Stopper-final drill / 34, 38



- Stopper-final drill / 43, 48

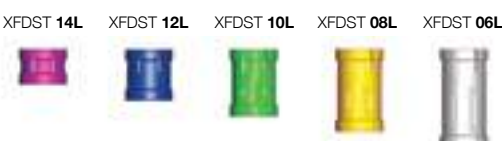

Drill

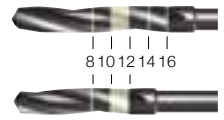

Unit: mm, Scale 1 : 1 / mm

Guide Drill

Diameter	L	Art. No.
Ø1.5	20	XGD 15 20
Ø1.5	28	XGD 15 28

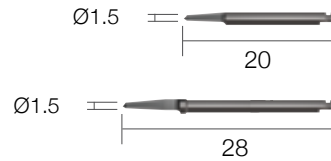

First Drill

Diameter	L	Art. No.
Ø2.0	29	XFD 20 29
Ø2.0	33	XFD 20 33

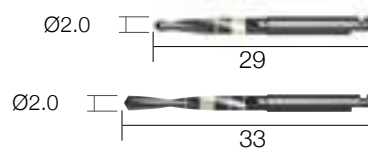

First Guide Drill

Diameter	L	Art. No.
Ø2.2	26	XLD 22 07
Ø2.2	29	XLD 22 29
Ø2.2	31	XLD 22 31
Ø2.2	33	XLD 22 33
Ø2.2	35	XLD 22 35
Ø2.2	41	XLD 22 41

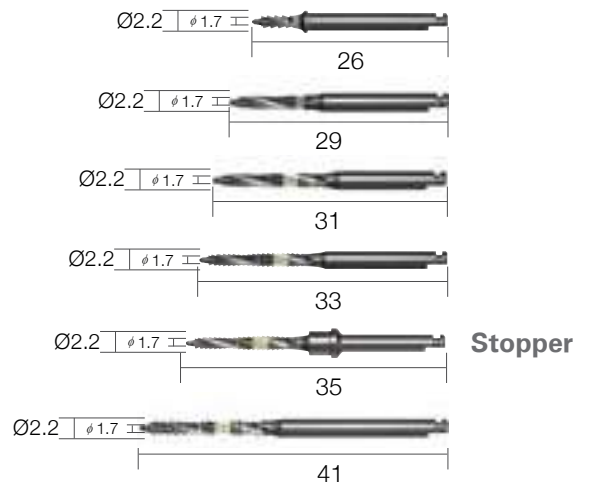

Second Guide Drill

Diameter	L	Art. No.
Ø2.6	26	XLD 26 07
Ø2.6	29	XLD 26 29
Ø2.6	31	XLD 26 31
Ø2.6	33	XLD 26 33
Ø2.6	35	XLD 26 35
Ø2.6	41	XLD 26 41

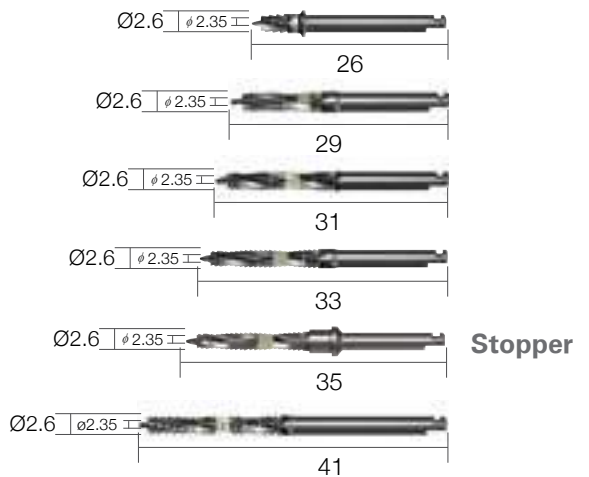

※ Note: Drill speed 1,000rpm, 30~45N·cm with irrigation.

Drill

Unit: mm, Scale 1 : 1 / mm

Pilot Drill

Diameter	L	Art. No.
Ø3.0	30	XPD 20 30



Final Drill | For Short Implant

Diameter	L	Art. No.
Ø3.6	27	XFC 36 07
Ø4.0	27	XFC 40 07
Ø4.5	27	XFC 45 07
Ø5.0	27	XFC 50 07
Ø6.0	27	XFC 60 07
Ø7.0	27	XFC 70 07

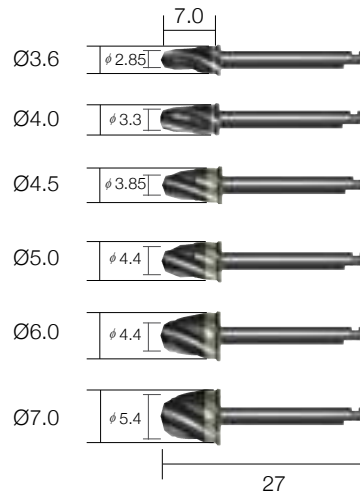

Final Drill | Length-29mm

Diameter	L	Art. No.
Ø2.85	29	XFD 34 29
Ø3.3	29	XFD 38 29
Ø3.85	29	XFD 43 29
Ø4.4	29	XFD 48 29
Ø5.4	29	XFD 58 29SW

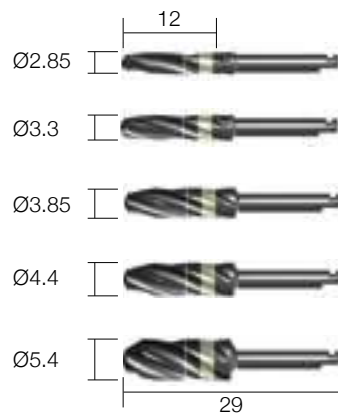

Final Drill | Length-31mm

Diameter	L	Art. No.
Ø2.85	31	XFD 34 31
Ø3.3	31	XFD 38 31
Ø3.85	31	XFD 43 31
Ø4.4	31	XFD 48 31
Ø5.4	31	XFD 58 31

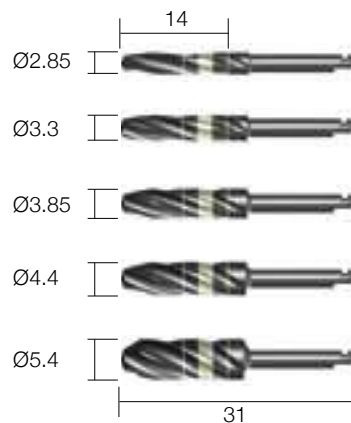

※ Note: Drill speed 1,000rpm, 30~45N·cm with irrigation.

Drill

Unit: mm, Scale 1 : 1 / mm

Final Drill | Length-33mm

Diameter	L	Art. No.
Ø2.85	33	XFD 34 33
Ø3.3	33	XFD 38 33
Ø3.85	33	XFD 43 33
Ø4.4	33	XFD 48 33

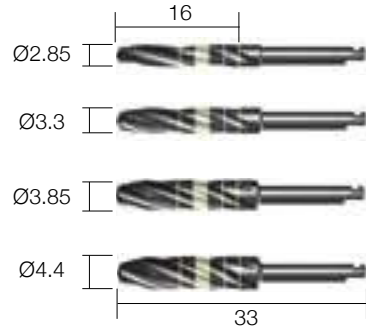

Final Drill | Length-35mm | Stopper

Diameter	L	Art. No.
Ø2.85	35	XFD 34 35
Ø3.3	35	XFD 38 35
Ø3.85	35	XFD 43 35
Ø4.4	35	XFD 48 35

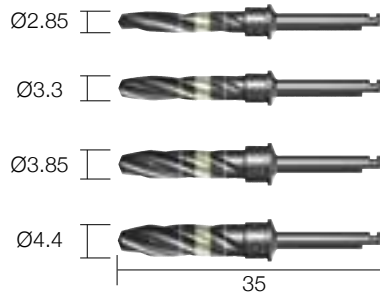

Final Drill | Length-41mm

Diameter	L	Art. No.
Ø2.85	41	XFD 34 41
Ø3.3	41	XFD 38 41
Ø3.85	41	XFD 43 41
Ø4.4	41	XFD 48 41

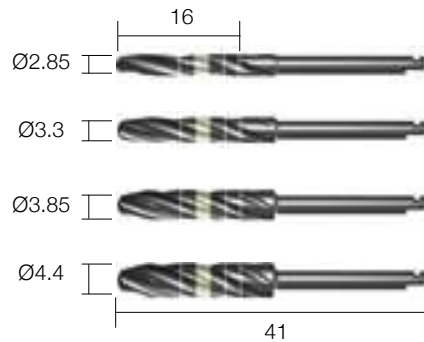

※ Note: Drill speed 1,000rpm, 30~45N·cm with irrigation.

Drill

Unit: mm, Scale 1 : 1 / mm

Harvest Drill | Length-35mm | Stopper

Diameter	L	Art. No.
Ø2.85	35	XFH 34 35
Ø3.3	35	XFH 38 35
Ø3.85	35	XFH 43 35
Ø4.4	35	XFH 48 35

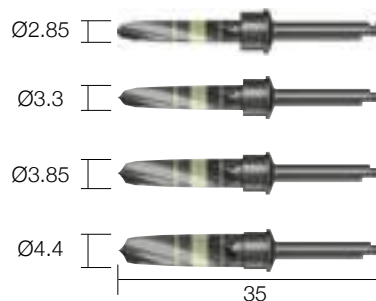

Countersink

Diameter	L	Art. No.
Ø3.6	29	XCS 36 29 SW
Ø4.0	29	XCS 40 29 SW
Ø4.5	29	XCS 45 29 SW
Ø5.0	29	XCS 50 29 SW
Ø6.0	27	XCS 60 29 SW
Ø7.0	27	XCS 70 29 SW

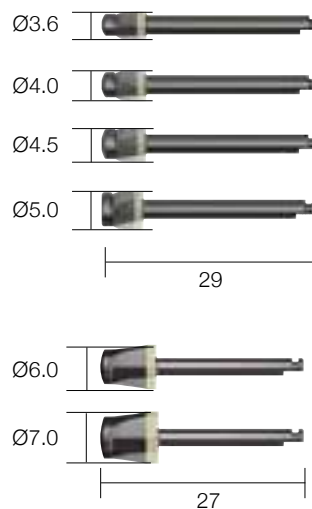

Round Bur

Diameter	L	Art. No.
Ø2.0	33	XRFB 20 33
Ø3.0	33	XRFB 30 33



※ Note: Drill speed 1,000rpm, 30~45N·cm with irrigation.

Stopper

Unit: mm, Scale 1 : 1 / mm

Stopper | For first guide drill, second guide drill

Drilling Depth	L	Art. No.
14	4.6	XLDST 14
12	6.6	XLDST 12
10	8.6	XLDST 10
08	10.6	XLDST 08
06	12.6	XLDST 06
04	14.6	XLDST 04
02	16.6	XLDST 02



Stopper | For final drill 3435, 3835

Drilling Depth	L	Art. No.
14	4.6	XFDST 14
12	6.6	XFDST 12
10	8.6	XFDST 10
08	10.6	XFDST 08
06	12.6	XFDST 06
04	14.6	XFDST 04
02	16.6	XFDST 02

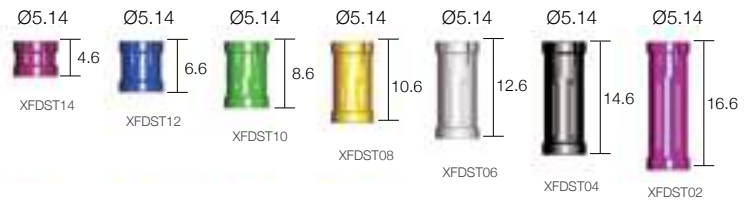

Stopper | For final drill 4335, 4835

Drilling Depth	L	Art. No.
14	4.6	XFDST 14L
12	6.6	XFDST 12L
10	8.6	XFDST 10L
08	10.6	XFDST 08L
06	12.6	XFDST 06L
04	14.6	XFDST 04L
02	16.6	XFDST 02L



Instrument

Unit:mm, Scale 1: 1 / mm

Adapter | Hex 1.28mm

Type	L	Art. No.
Hand-piece	27	XID 27 H
	30	XID 30 H
	32	XID 32 H
Ratchet	24	XID 24 W
	26	XID 26 W
	29	XID 29 W
	29	XID 32 W

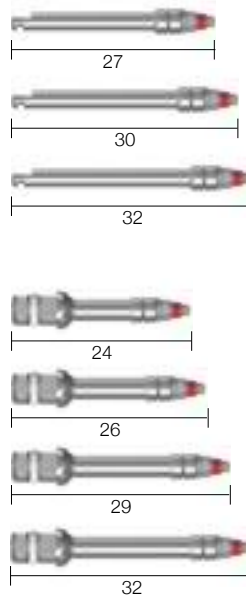

Parallel Pin | For first guide drill, second guide drill

Diameter	Art. No.
Ø1.6	XPP 162212
Ø1.6	XPP 162220T
Ø1.6	XPP 162226T

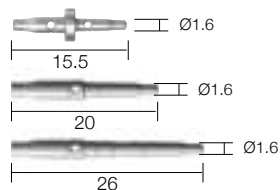

Path Pin

L	Art. No.
18.6	XMFPA2

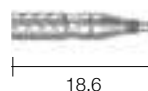

Instrument

Unit:mm, Scale 1: 1 / mm

Hex Driver | Hex 1.28mm

Type	L	Art. No.
Hand-piece	25	XHD 25 H
Ratchet	21	XHD 21 W
	25	XHD 25 W
	27	XHD 27 W
Manual	26	XHD 26 T
	30	XHD 30 T

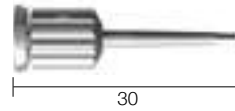
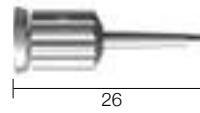
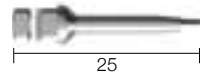
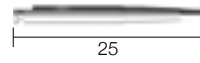

Slot Driver

Type	Art. No.
Ratchet	SDA 17 R
	SDA 25 R

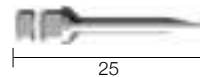
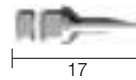

Drill Extension

XDE

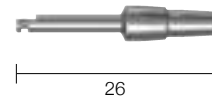

Driver | Manual

Type	Art. No.
Manual	XHDHT



Instrument

Unit: mm

Adapter | For screw & ball abutment | Scale 1 : 1 / mm

Type	Art. No.
Hand-piece	XMAA1
Ratchet	XMA 21W

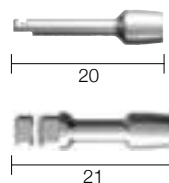

Adapter | For mini ball abutment | Scale 1 : 1 / mm

IPST21W



Ratchet

XRCA1



Torque Wrench | Scale 1 : 0.7 / mm

XNTW



Depth Gauge

XDGL

※ Note: One side of Depth Gauge measures the osteotomy depth and the other side measures the gingival height from the top of the implant.



Tissue Punch | Scale 1 : 1 / mm

XTS40



※ Punching size : Ø4.0

DASK [Dentium Advanced Sinus Kit]

Unit:mm, Scale 1: 1.5 / mm



Kit Contents

- DASK drill



- Stopper



- Sinus elevation instrument



Sinus Bur Kit / Sinus Kit

Unit:mm, Scale 1: 1.5 / mm

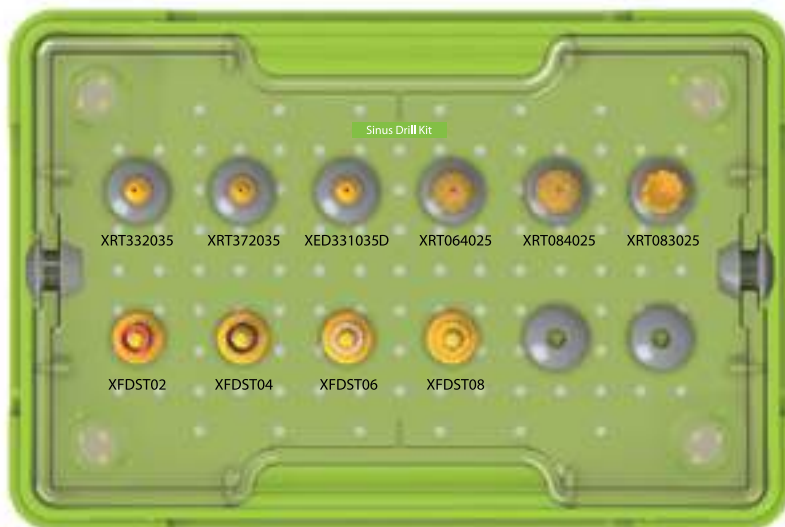

SDK

Kit Contents

- DASK drill

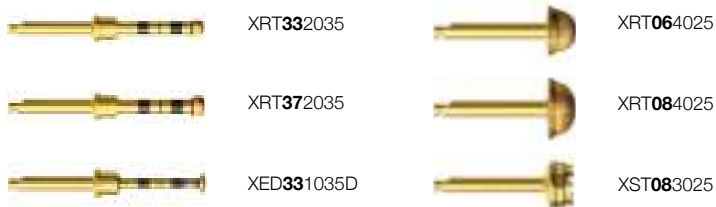

- Stopper



Sinus Kit

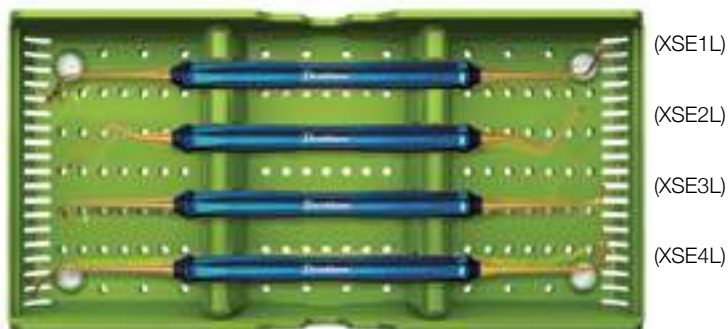

XSKL

DASK / Sinus Bur Kit / Sinus Kit

Unit: mm

DASK Drill | Scale 1 : 1.2 / mm

Type	DASK Drill #	Art.No.
Crestal Approach	DASK Drill #1	XRT 33 2035
	DASK Drill #2	XRT 37 2035
	DASK Drill #3	XED 33 1035D
Lateral Approach	DASK Drill #4	XRT 06 4025
	DASK Drill #5	XRT 08 4025
	DASK Drill #6	XST 08 3025

※ Note: Drill speed 800 to 1,200rpm, 30~45N-cm with irrigation.

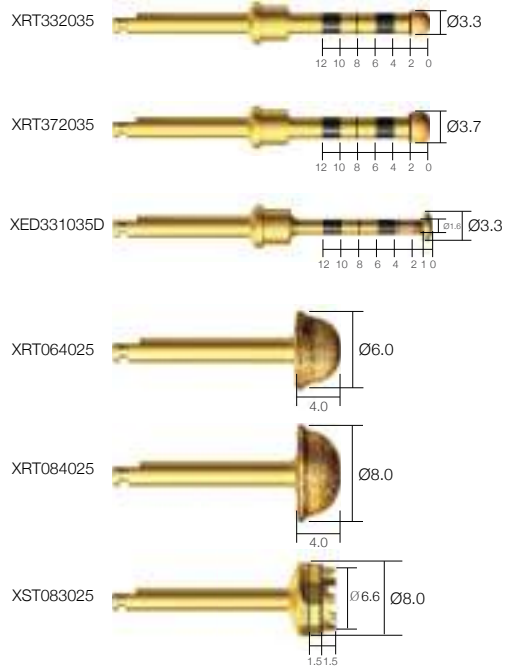

Stopper | For XRT332035, XRT372035, XED331035D | Scale 1 : 1 / mm

Drilling Depth	L	Art.No.
08	10.6	XFDST 08
06	12.6	XFDST 06
04	14.6	XFDST 04
02	16.6	XFDST 02



Sinus Elevation Instrument | Scale 1 : 0.45 / mm

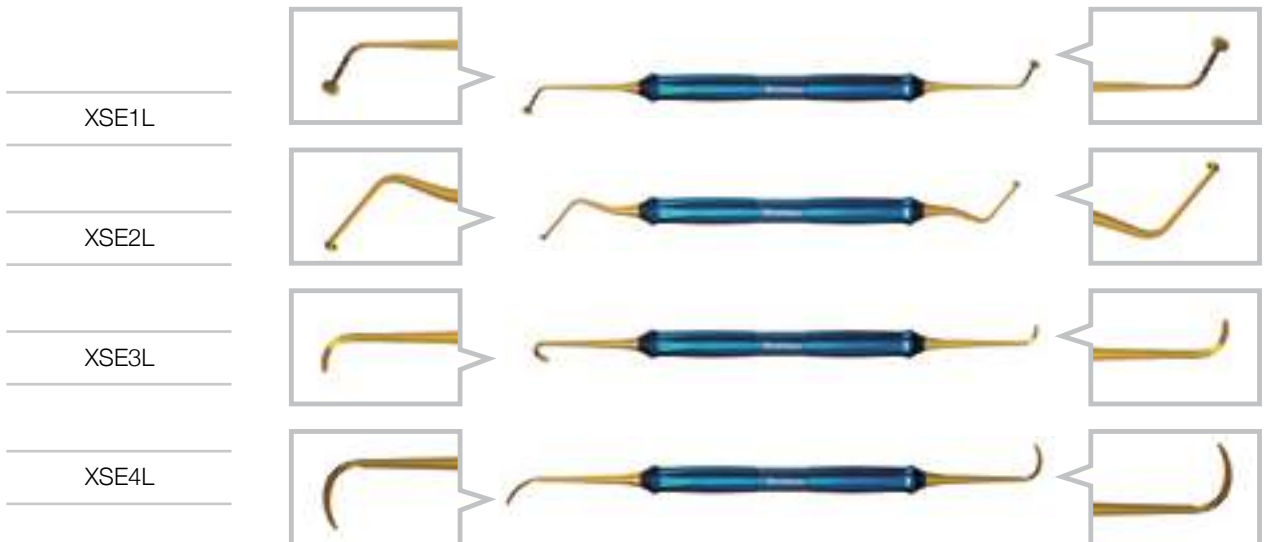

Osteotome Kit

Unit: mm

Osteotome Kit

Osteotome compresses the bone laterally, providing denser bony interface rather than removing valuable bone from the surgical site.



Osteotome | Final drill type | Scale 1 : 0.4 / mm

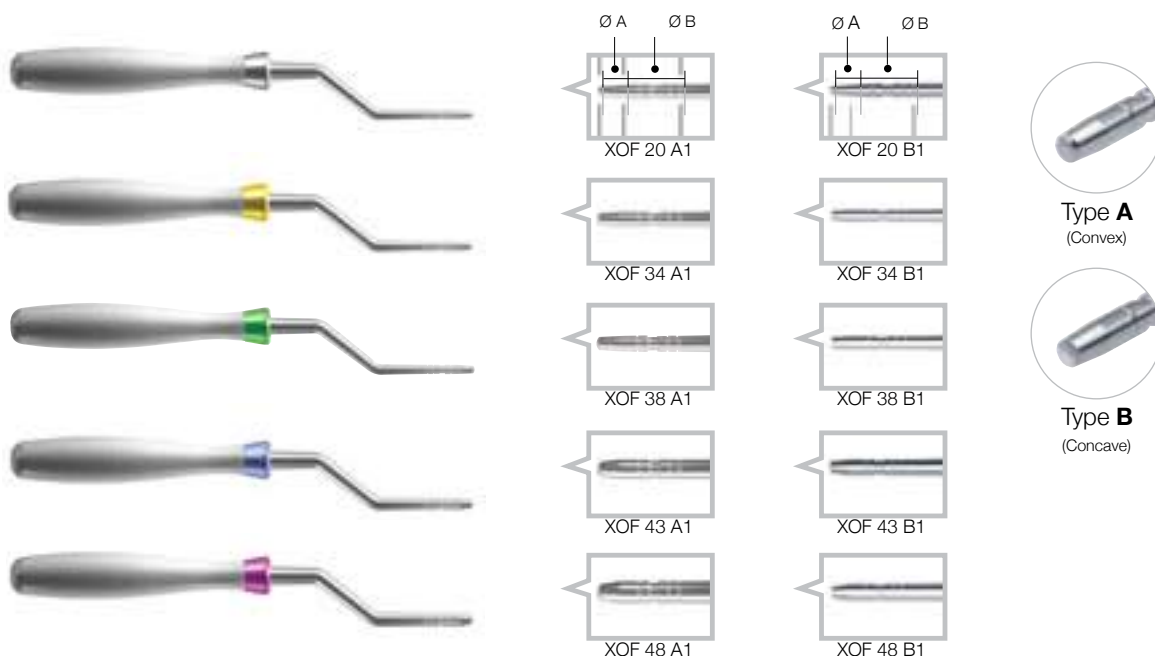

Osteotome Kit

Type	Art.No.	Ø A	Ø B
XOFK Type A (Convex)	XOF 20 A1	Ø 1.7	Ø 2.8
	XOF 34 A1	Ø 2.3	Ø 2.8
	XOF 38 A1	Ø 2.7	Ø 3.2
	XOF 43 A1	Ø 2.8	Ø 3.8
	XOF 48 A1	Ø 3.0	Ø 4.3
XOFBK Type B (Concave)	XOF 20 B1	Ø 1.7	Ø 2.8
	XOF 34 B1	Ø 2.3	Ø 2.8
	XOF 38 B1	Ø 2.7	Ø 3.2
	XOF 43 B1	Ø 2.8	Ø 3.8
	XOF 48 B1	Ø 3.0	Ø 4.3

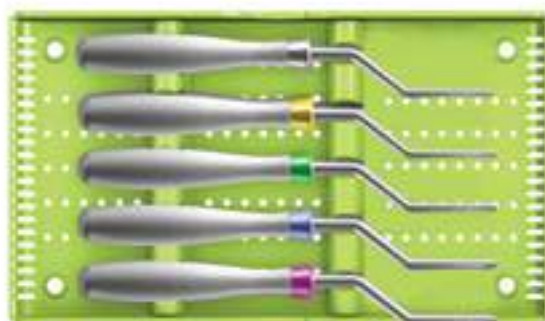

XOFK (Type A)

XOFBK (Type B)

Trephine Kit

Unit: mm

Trephine Bur

- Excellent fine cutting
- Strong engagement when attaching the trephine to cortical bone
- Cut-outs facilitates ease of harvest retrieval
- 5 scale marks on the Trephine drill from 2mm to 10mm
- Easy harvesting

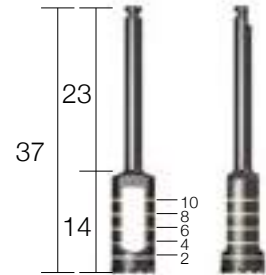

Trephine Bur | Scale 1 : 0.5 / mm

Outer Diameter	Inner Diameter	Art. No.
Ø3.0	Ø2.3	XTP 24 03
Ø4.0	Ø3.3	XTP 34 04
Ø5.0	Ø4.2	XTP 44 05
Ø6.0	Ø5.2	XTP 54 06
Ø7.0	Ø6.1	XTP 64 07
Ø8.0	Ø7.1	XTP 74 08
Ø9.0	Ø8.0	XTP 84 09
Ø10.0	Ø9.0	XTP 94 10

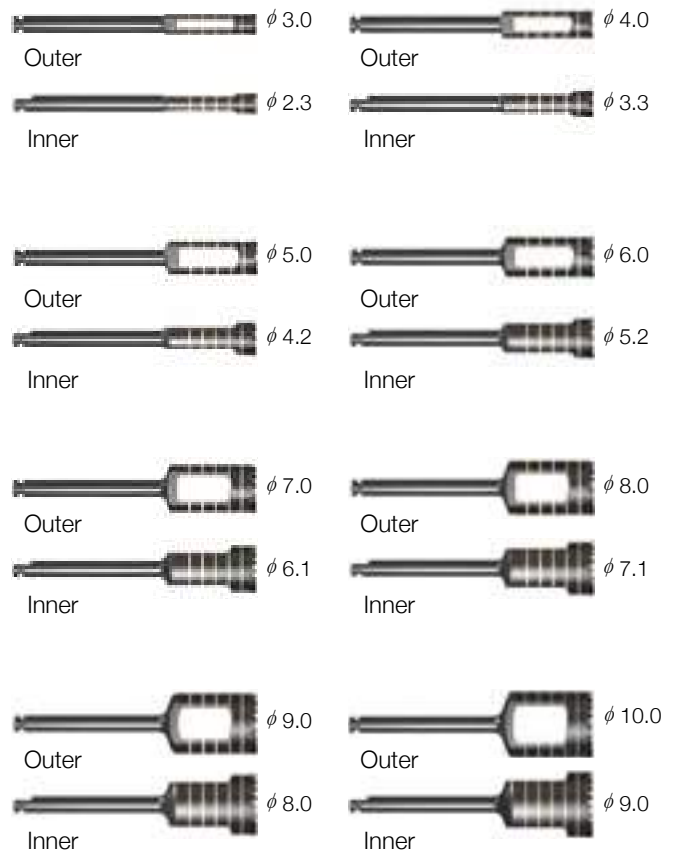

Trephine Kit

XIT

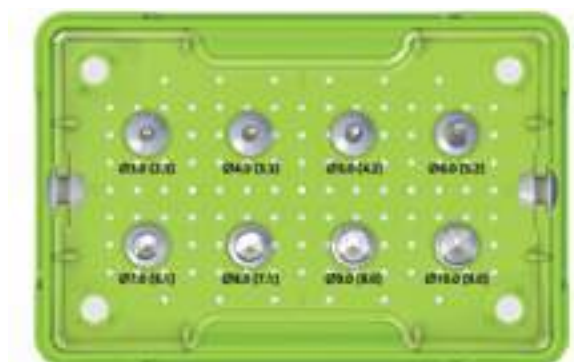

Prosthetic Kit

Unit:mm, Scale 1: 1.5 / mm

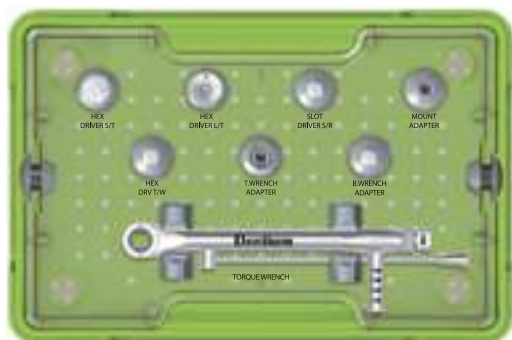

XIP

Hex Driver L/T | Scale 1 : 1 / mm

XHD 30 T



Mount Adapter | Scale 1 : 1 / mm

XMAA1



T/W Adapter | Scale 1 : 1 / mm

XMA 21 W



Torque Wrench | Scale 1 : 0.5 / mm

XNTW

Hex Driver S/T | Scale 1 : 1 / mm

XHD 15



Slot Driver | Scale 1 : 1 / mm

SDA 25 R



Hex Driver T/W | Scale 1 : 1 / mm

XHD 25 W



Mini Ball Adapter | Scale 1 : 1 / mm

IPST 21 W



Planning Kit

Unit: mm, Scale 1 : 1 / mm



XPK

Kit Contents

Diameter Ø4.5 | Combi & Dual abutment

G/H	Art.No.
1.5	PDAB 45 15
2.5	PDAB 45 25
3.5	PDAB 45 35
4.5	PDAB 45 45
5.5	PDAB 45 55



Diameter Ø5.5 | Combi & Dual abutment

G/H	Art.No.
1.5	PDAB 55 15
2.5	PDAB 55 25
3.5	PDAB 55 35
4.5	PDAB 55 45
5.5	PDAB 55 55



Diameter Ø6.5 | Combi & Dual abutment

G/H	Art.No.
1.5	PDAB 65 15
2.5	PDAB 65 25
3.5	PDAB 65 35
4.5	PDAB 65 45
5.5	PDAB 65 55



Angled 15° | Angled abutment

Diameter	G/H	Art.No.
Ø4.5	2.0	PAAB 15 45 20
Ø4.5	4.0	PAAB 15 45 40
Ø5.5	2.0	PAAB 15 55 20
Ø5.5	4.0	PAAB 15 55 40

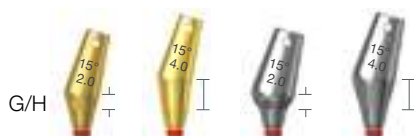

Angled 25° | Angled abutment

Diameter	G/H	Art.No.
Ø4.5	2.0	PAAB 25 45 20
Ø4.5	4.0	PAAB 25 45 40
Ø5.5	2.0	PAAB 25 55 20
Ø5.5	4.0	PAAB 25 55 40



Prosthetic and Laboratory Instrument

Unit: mm

Hex Driver | Hex 1.28 mm | Scale 1 : 1 / mm

L	Art. No.
13	XHD 13
15	XHD 15
21	XHD 21
28	XHD 28

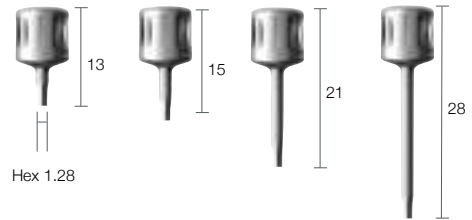

Reamer Guide for Combi/Dual Abutment | Scale 1 : 1 / mm

Diameter	Art. No.
Ø 4.5	CRG 45 L
Ø 5.5	CRG 55 L
Ø 6.5	CRG 65 L



Reamer Guide for Screw Abutment | Scale 1 : 1 / mm

Type	Art. No.
Bridge	SRG BL
Single	SRG SL



Prosthetic and Laboratory Instrument

Unit:mm

Reamer Handle | Scale 1 : 0.5 / mm

CRH



Hand Wrench | Scale 1 : 1 / mm

XHW



Reamer (Combi/Dual Abutment) | Scale 1 : 1 / mm

CRM



Reamer (Screw Abutment) | Scale 1 : 1 / mm

SRM



Help Kit

Unit: mm

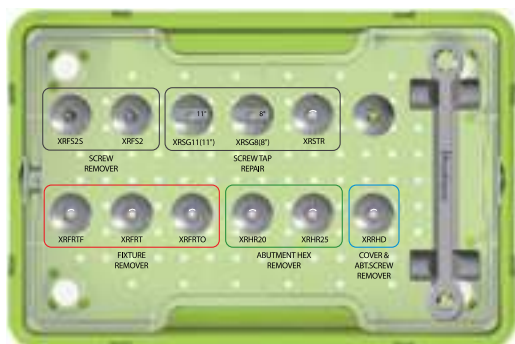

XIH

Cover & Abutment Screw Remover

| Scale 1 : 1 / mm

L	Art. No
25	XRRHD



Abutment Hex Remover | Scale 1 : 1 / mm

L	Art. No
20	XRHR20
25	XRHR25

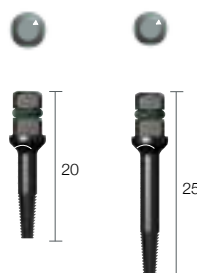

Screw Remover | Scale 1 : 1 / mm

L	Art. No
25	XRFS2S
33	XRFS2



Fixture Remover | Scale 1 : 1 / mm

Type	Art. No
Remover	XRFRT
	XRFRTF
	XRFRT0
Wrench	XRFRW

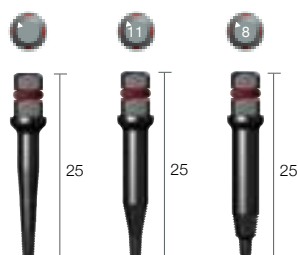

Screw Tap Repair | Scale 1 : 1 / mm

Type	Art. No
Tap	XRSTR
11° Guide	XRSG11
8° Guide	XRSG8

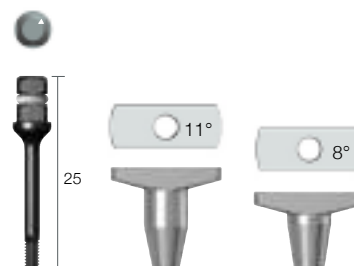

75



SURGICAL MANUAL

Surgical Drill Sequence I	74
Surgical Drill Sequence II	76
Drilling Depth Guide	78
Fixture Connection	80
Installation Procedure & Warnings	81
Surgical Kit Maintenance	82

Surgical Drill Sequence I

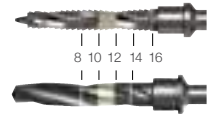

Drilling Sequence Guide (Final drill)

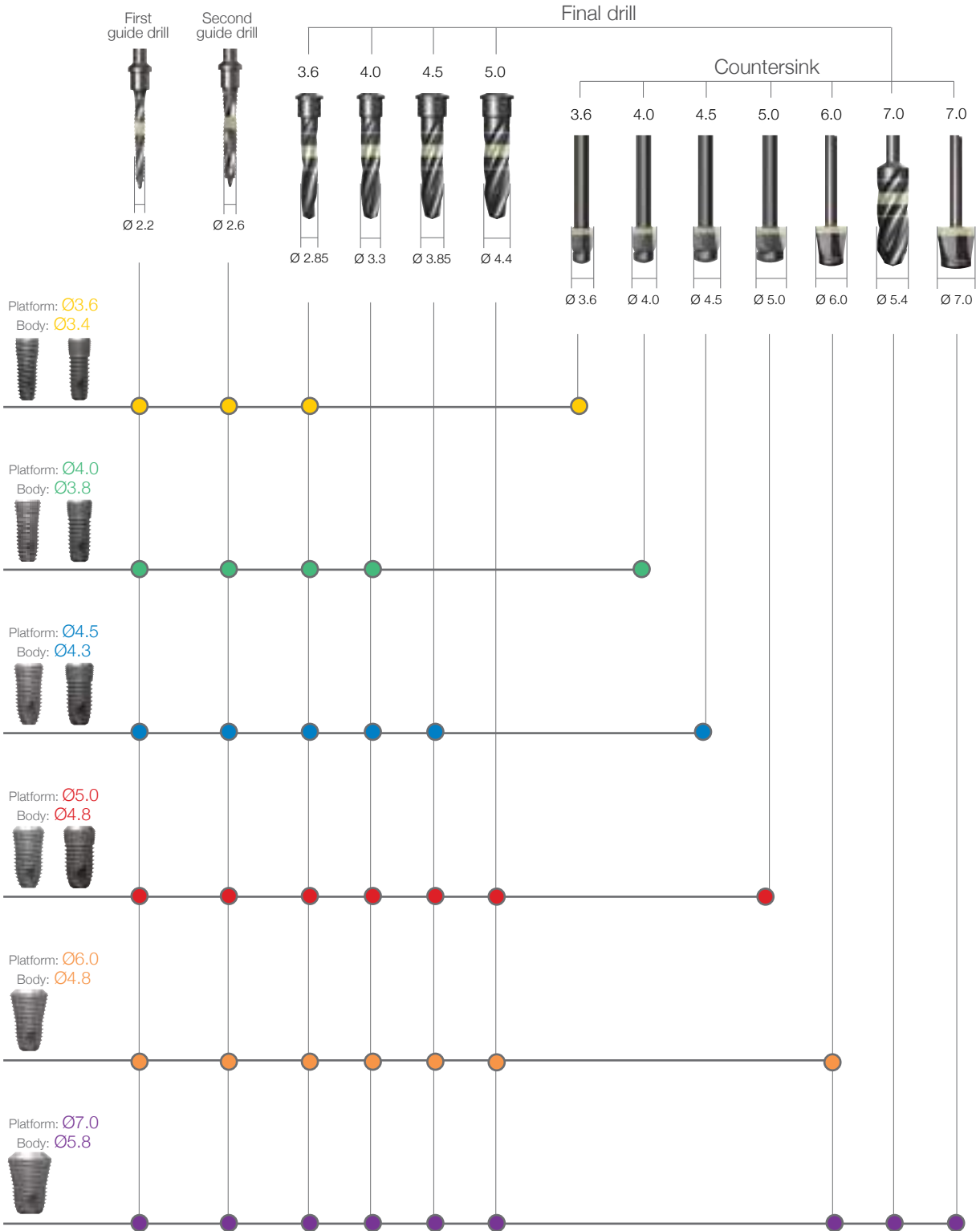

During Fixture Insertion, 30 ~ 45N-cm Torque at 20rpm is Recommended.

- Countersink drill is used in cases with dense cortical bone.
- If the bone density is D1~D3, it is recommended to countersink after final drill.
- The actual diameter of the Countersink drill is 0.1mm larger than the fixture platform.

Determination of Fixture Top Level

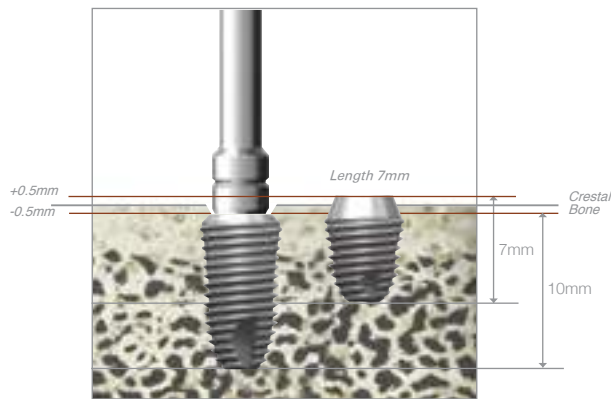

Top level of fixture needs to be located 0.5mm below the marginal crestal bone level to minimize bone loss after implantation. However, only for the fixture of 7mm length, top level of fixture should be located 0.5mm above the marginal crestal bone level.

Depth Indication



- Use the depth gauge after first drill / First guide drill to check depth of drilling
- Place the depth gauge against the wall of the osteotomy

Surgical Drill Sequence II



Drilling Sequence Guide (Havrest drill)

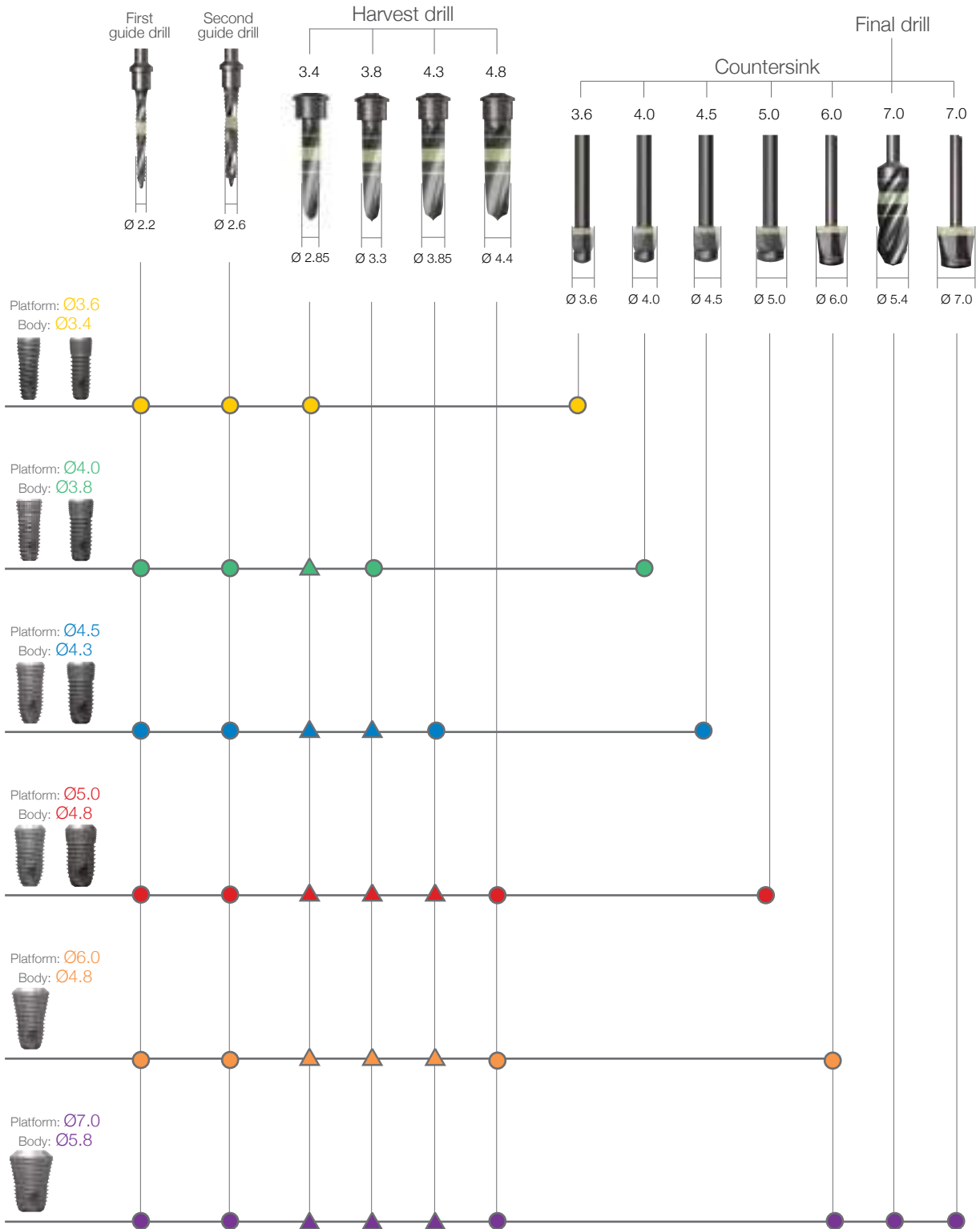

△ : During the 4.3/4.8 fixture insertion into the bone density of D3~D4, the 3.4/3.8 harvest drilling process can be skipped.

Harvest Drill

Simultaneous and effective autogenous bone collection during the final drilling procedure using a specially designed drill.

- Sharp pointed tip design of the drill prevents drill chatter and helps guide the drill path.
- Available drill stopper helps control drill depth for safe and efficient bone collection, especially in the buccal side of ridge.
- Recommended drill speed of less than 100rpm/50N·cm helps preserve the vital autogenous bone.
- Excellent clinical results may be achieved when harvested autogenous bone is combined with OSTEON™ II.

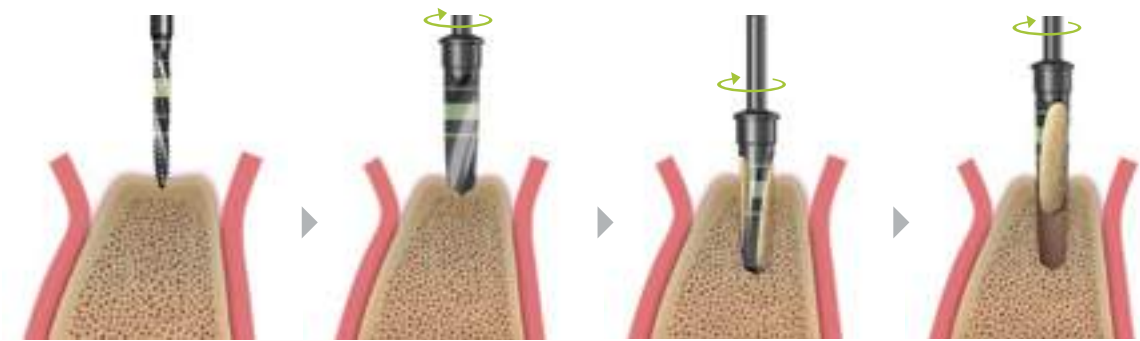

First / Second guide drill
1000rpm / 30~45N·m with irrigation

Harvest drill
30~100rpm / 30~50N·m without irrigation

Bone collection in the buccal side of ridge : 50~200rpm / 30~50N·cm

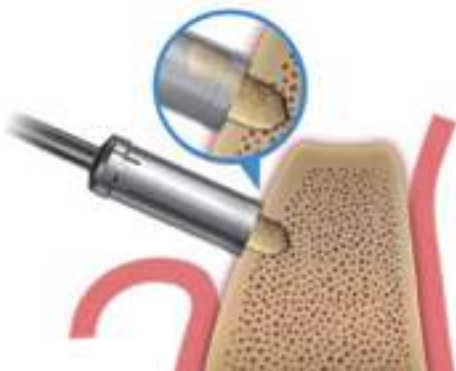

Stopper
Locking with drill stopper for bone collection

Drilling Depth Guide

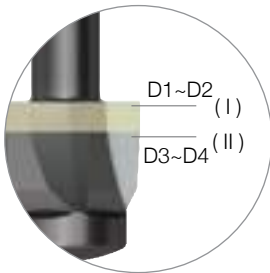

Countersink Depth Guide

- Drilling depth of the countersink depends on the patient's bone quality.
- If the bone density is D1~D2, it is recommended to drill up to the top line (I) of laser mark on the countersink.
- If the bone density is D3~D4, it is recommended to drill up to the bottom line (II) of laser mark on the countersink.

Platform: Ø3.6 / Body: Ø3.4

(1000rpm / 30~45N-cm)

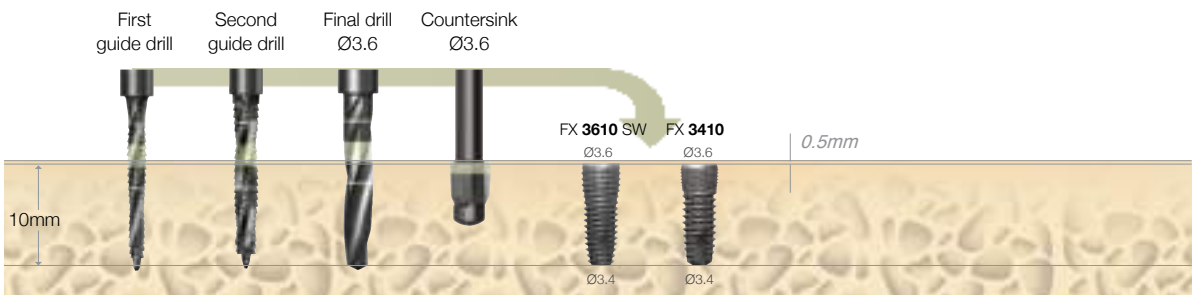

Platform: Ø4.0 / Body: Ø3.8

(1000rpm / 30~45N-cm)



Platform: Ø4.5 / Body: Ø4.3

(1000rpm / 30~45N-cm)

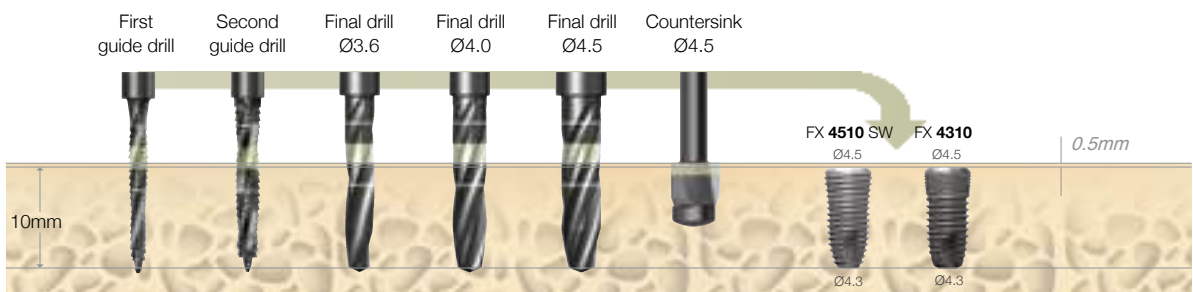

Platform: Ø5.0 / Body: Ø4.8

(1000rpm / 30~45N-cm)

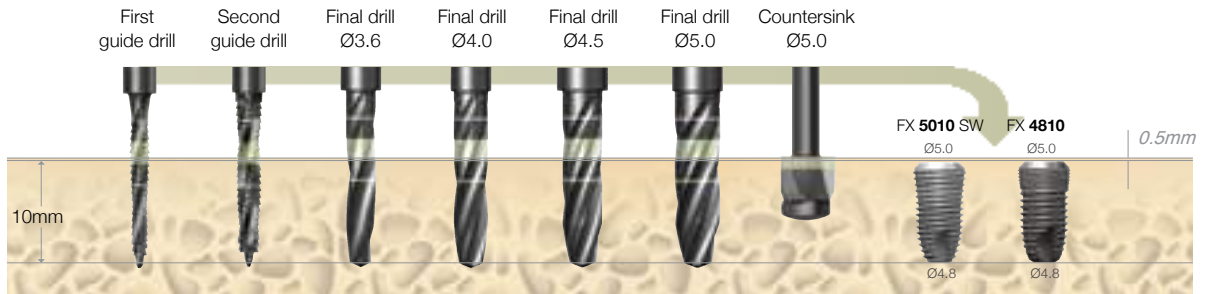

Platform: Ø6.0 / Body: Ø4.8

(1000rpm / 30~45N-cm)

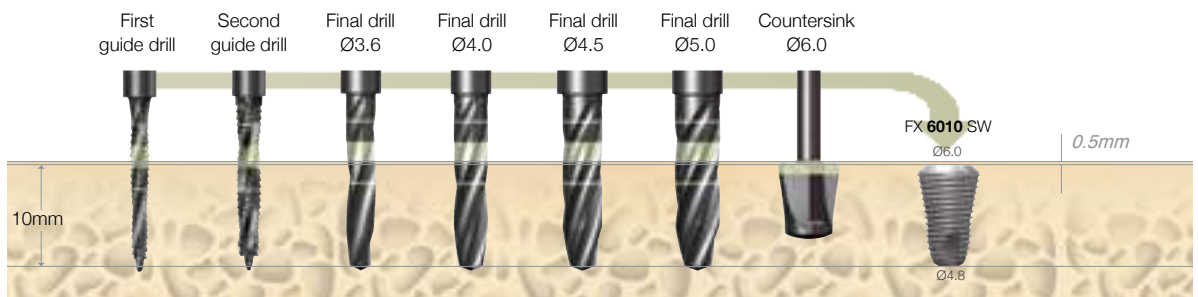

Platform: Ø7.0 / Body: Ø5.8

(1000rpm / 30~45N-cm)

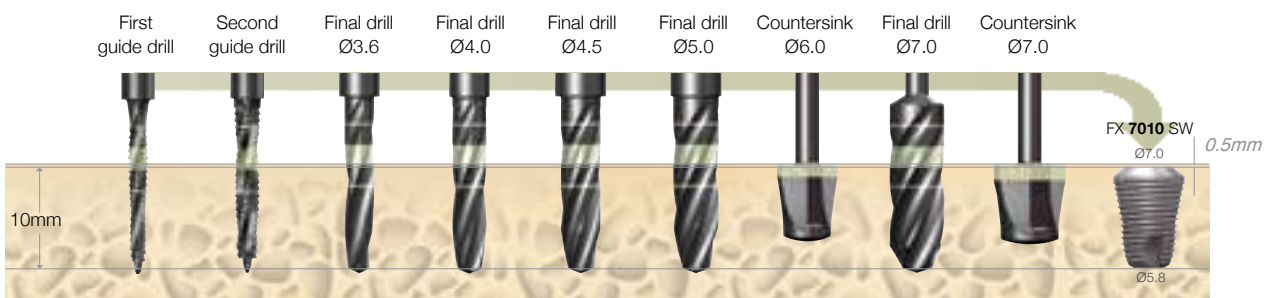

Fixture Connection



Caution_ When opening the fixture pack, hold the fixture container upward and engage the adapter into the fixture.



By hand-piece
20rpm / 35N-cm



By ratchet



Directions Using the Hand-piece / Ratchet Adapter



Hand-piece
adapter

Ratchet
adapter

The Hand-piece Adapter/Ratchet Adapter must be connected firmly together with the internal hex inside the fixture

Installation Procedure & Warnings

Cover Screw



By hex driver



Cover screw (CS36)
connection

Healing Abutment



By hex driver



Healing abutment connection



Healing abutment (HAB402020L)
connection in thin gingiva

Warnings

Dental Implant surgery and restoration involve complex dental procedures. Appropriate and adequate training in proper technique is strongly recommended prior to use.

- Improper medical examination and/or treatment plan can result in implant failure and/or loss of supportive bone.
- Improper initial stability and/or excessive occlusal forces during healing period may lead to Osseointegration failure.
- Excessive insertion torque may lead to mechanical failure or implant biologic failure due to bone compression and necrosis.
- When forces or loads are greater than its design, implant or abutment fracture could happen. Therefore clinicians should make careful decisions with regards to clinical treatment planning to minimize the risk of fracture. Appropriate implant quantity, occlusal interface and a nightguard are essential. Potential excessive loading conditions may include the following:

- 01 Inadequate number of implants are placed.
- 02 Implant width and/or length are inappropriate for a treatment site.
- 03 Prosthesis which has excessive cantilever length due to inadequate biomechanical design.
- 04 Continuous occlusal force are generated by incomplete connection between implant and abutment and/or abutment screw loosening.
- 05 Direct casting abutment angles are greater than 30° from the vertical axis of the implant.
Direct abutments are not for angulation.
- 06 Occlusal interferences causing excessive lateral forces
- 07 Patient parafunctions such as bruxism
- 08 Inadequate dental laboratory casting procedures
- 09 Improper prosthesis fit
- 10 Trauma from patient habits or accidents
- 11 Excessive marginal bone loss caused by inadequate bone width and/or advanced periimplantitis

Surgical Kit Maintenance

Sterilization and Instrument Care Procedures

- Please follow legal regulations, as well as hygienic guidelines to prevent contamination and infection through prevention.
 - Please remember that you are responsible for the maintenance and sterility of your medical / dental products / device. It is important to use and follow proper cleaning, disinfection and sterilization procedures.
 - It is also important to follow the manufactures recommendation on the usage of drills.
Please keep a log as to how many times the drills are used.
 - Drills are used per implant placed not per patient. Bone density determines the life of the drills.
 - Replace white and red o-rings on adapters and hex drivers, if worn and dried out.
 - Drills should be considered for replacement around 20 uses based on bone density.
- 01 All instruments immediately after use must be pre-soaked for a few minutes in a germicidal bath to loosen and prevent debris from attaching to instruments. Do not soak over-night.
 - 02 Scrub with a soft brush to remove any debris.
 - 03 For internal irrigation drills use a reamer or small gauge needle to cleanout drill internally.
 - 04 If using an ultrasonic cleaner, wrap drills in a 2 × 2 to prevent rubbing against each other.
 - 05 Rinse thoroughly under warm water.
 - 06 Clean all instrument trays with a germicidal cleaner prior to replacing instruments in kit.
 - 07 Dry completely and place back into kit.
 - 08 Always check for damage or corrosion after rinsing and drying.
 - 09 Seal the tray in a sterilization pouch.
 - 10 Sterilize using a steam autoclave at 121°C / 250°F for 30 minutes or refer to manufacture's recommendations.
 - 11 Store in a dry area at room temperature.

Maintenance Period for Surgical Drills

All surgical drills shall be replaced after approximately 40 uses based on

bone density



Guide Drill (First / Second)

1000rpm, 30~45N·cm with Irrigation

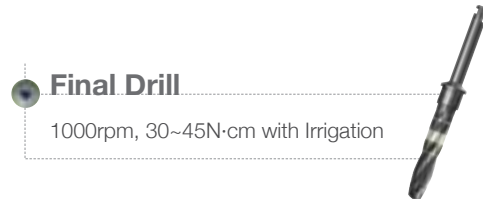

Final Drill

1000rpm, 30~45N·cm with Irrigation

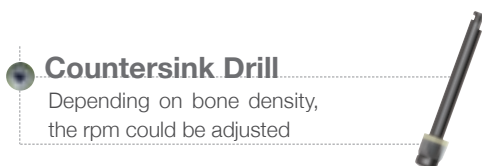

Countersink Drill

Depending on bone density,
the rpm could be adjusted

PROSTHESIS MANUAL

Prosthetic Introduction

Understanding the Implant and Prosthesis	84
Types of Abutment	85
Dual Abutment	86
Combi Abutment	87
Dual Milling / Anged / Temporay / Direct-Casting / Metal-Casting Abutment	88
Screw Abutment / Angled Screw Abutment	90
Points to Consider in Abutment Selection	91
Minimum Height Requirement for SuperLine Prosthetic Abutment	92

Prosthetic Procedure 1

Abutment Level- Dual Abutment	94
Abutment Level- Combi Abutment	97

Prosthetic Procedure 2

Fixture Level [Pick-up Type]- Dual Abutment	100
Fixture Level [Transfer Type]- Dual Abutment	103
Fixture Level [Transfer Type]- Dual Milling Abutment	106
Fixture Level [Pick-up Type]- Angled Abutment	108
Fixture Level- Direct-Casting Abutment	110
Fixture Level- Metal-Casting Abutment	111
Fixture Level [Pick-up Type]- Temporary Abutment	112

Prosthetic Procedure 3

Abutment Level [Transfer Type]- Screw Abutment	114
--	-----

Cementation Repair Method (SCRIP)

Prosthetic Procedure 4

Positioner	120
Ball Attachment	122
Magnetic Attachment	124

Understanding the Implant and Prosthesis



Biological Connection

- The tapered conical hex connection between implant and abutment interface provides hermetic sealing.
- The biological connection distributes the load to the fixture evenly. Therefore it may minimize bone loss.
- All implant diameters share the same internal connection. One abutment screw fits all abutments and fixtures.



Types of Abutment (Abutments are available in various diameters & gingival heights)

- Dual Abutment
- Combi Abutment
- Dual Abutment
- Dual Milling Abutment
- Angled Abutment (15°/25°)
- Direct-Casting Abutment
- Metal-Casting Abutment
- Temporary Abutment (Plastic & Titanium)
- Screw Abutment
- Angled Screw Abutment (15°/ 30°)
- Positioner Attachment
- Ball Attachment
- Magnetic Attachment

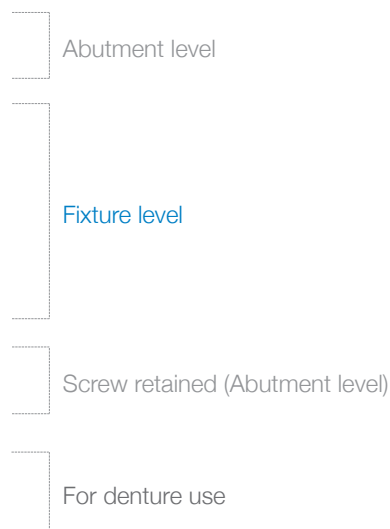

Types of Abutment

One-Piece	Two-Pieces	
 <p>Combi Abutment</p>	 <p>Dual Abutment</p>  <p>Dual Milling Abutment</p>	
 <p>Screw Abutment</p>	 <p>Angled Abutment</p>  <p>Direct-Casting Abutment</p>	
 <p>Cylinder</p>	 <p>Metal-Casting Abutment</p>  <p>Temporary Abutment</p>	
<p>Abutment Level</p>	<p>Fixture Level</p>	

- Straight abutments are Dual and Combi.
- Depending on the insertion angle and position of the fixture, the Angled or Direct / Metal casting abutment may be used.
- The Screw abutment can be used when prosthesis retrieval is anticipated.

Selection Guideline

Ideal emergence profile for each tooth



Dual Abutment



Dual Abutment

- It is possible to take an impression at both fixture level and abutment level. (A dual abutment may be interchanged with a combi abutment.)
- For abutment level impressions, the same prosthetic procedures apply to both dual and combi abutments.
- For fixture level impressions, the abutment selection takes place on the master model.
- For fixture level impressions, a precise positioning jig for abutment may be required.
- Either hex or non-hex abutments may be used, according to operator's preference.

* If a cement retained restoration requires retrieval, cutting a hole in the occlusal surface would allow access to the screw to permit removal.

Hex / Non-hex

	Hex	Non-hex
Positioning Jig	Unnecessary	Required
Radiograph	Required	Unnecessary

Dual Abutment (Hex / Non-hex)

Diameter	G/H	Verticle Angle
Ø4.5	1.0mm, 1.5mm, 2.5mm, 3.5mm, 4.5mm, 5.5mm	5°
Ø5.5	1.5mm, 2.5mm, 3.5mm, 4.5mm, 5.5mm	6°
Ø6.5	1.5mm, 2.5mm, 3.5mm, 4.5mm, 5.5mm	7°



Combi Abutment

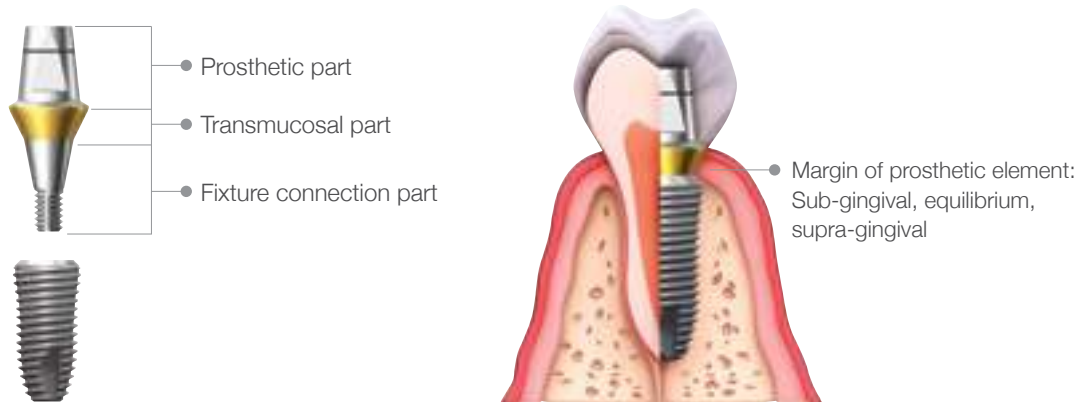

- The Combi abutment is used when the implant position is optimal.
- If the abutment selection is made in the mouth, gauge the thickness of mucosa with the depth gauge to measure the gingival height thus allowing the appropriate abutment height.
- The Impression is taken with the snap cap
- When using the Combi abutment, it remains in the mouth after the impression is taken. (DO NOT REMOVE OR CHANGE ITS POSITION).
- Tighten abutment screw to 25 - 35 N·cm (retighten again before seating final prosthesis).

* If the Combi abutment is too long it can be adjusted 1.5mm to the bottom of the laser mark on the vertical stack of the abutment. The Combi abutment has a short analog for the 1.5mm adjustment.

* A resin jig can be made to record the reduction if reduced more than 1.5mm.

Combi Abutment Line Up

Diameter	G/H	Vertical Angle
Ø4.5	1.0mm, 1.5mm, 2.5mm, 3.5mm, 4.5mm, 5.5mm	5°
Ø5.5	1.5mm, 2.5mm, 3.5mm, 4.5mm, 5.5mm	6°
Ø6.5	1.5mm, 2.5mm, 3.5mm, 4.5mm, 5.5mm	7°



Dual Milling / Angled / Temporary / Direct-Casting Abutment / Metal-Casting Abutment



Dual Milling Abutment

- Impression is taken at fixture level.
- When using a non-hex abutment a precise seating jig should be used.
- Either hex or non-hex abutments may be used, according to operators preference.

* If a cement retained restoration requires retrieval, cutting a hole in the occlusal surface would allow access to the screw for removal.

Angled Abutment

- The Angled Abutment is recommended when the restoration path of insertion is unfavorable in either anterior or posterior sites.
- Retention force can be increased through milling process.



Direct-Casting Abutment

- Excellent for either single or for bridgework.
- Used as an esthetic custom made abutment.
- Used when angulation is not ideal and a standard abutment cannot be used.
- Used when there is inadequate inter-arch distance and a standard abutment cannot be used.
- A fixture level impression is taken, and the soft tissue contours can be supported.

Dual Milling / Angled / Temporary / Direct-Casting Abutment / Metal-Casting Abutment

Metal-Casting Abutment

- Equivalent results for a fraction of the price!
- Our highly affordable metal alloy replaces expensive gold to alleviate financial burden to all.

Temporary Abutment

- Temporary abutments are available with titanium or plastic.
- The titanium abutment comes in hex and non-hex both with a gingival height of 1.0mm.
- The plastic abutment comes in diameters (Ø4.5, 5.5, 6.5) with a gingival height of 2.0mm.

Fixture Level Abutment (Hex / Non-hex)

Abutment	Diameter	G/H	Angle
Dual Milling 	Ø4.0	1.0mm	X
	Ø4.5	1.5mm	
	Ø5.5	1.5 / 2.5mm	
	Ø6.5	1.5 / 2.5 / 3.5mm	
	Ø7.5	2.5 / 3.5mm	
Angled 	Ø4.5	1.5mm 2.5mm 3.5mm	15° / 25°
	Ø5.5	1.5mm 2.5mm 3.5mm	15° / 25°
Direct-Casting Abutment 	Ø4.5	1.0mm	X
Metal-Casting Abutment 	Ø4.5	1.0mm	X
Ti-Temporary 	Ø4.5	1.0mm	X
Plastic Temporary 	Ø4.5 Ø5.5 Ø6.5	2.0mm	X

Screw Abutment



Screw Abutment



Angled Screw Abutment

If prosthesis repair is anticipated, use of a screw abutment retained prosthesis enables easy retrieval.

- Useful for connecting multiple units or if there is a preference for a screw retained prosthesis.
- Useful when respective long axes of implants differ. Each side tapers by 30° and this permits up to 60° divergence between two abutments.
- Useful if the prognosis of an adjacent restoration is not ideal thus permitting easy retrieval and modification of the restoration.

Ti-Retaining Screw (1.8mm - body diameter)

- Can minimize screw loosening due to increased approximal space.
- Can endure various kinds of masticatory force.



2.3mm
1.8mm



Screw Abutment

Diameter	G/H
Ø4.5	1.0mm, 1.5mm, 2.5mm, 3.5mm, 4.5mm, 5.5mm
Ø5.5	1.5mm, 2.5mm, 3.5mm, 4.5mm, 5.5mm

Angled Screw Abutment

Diameter	G/H	Angled
Ø4.5	1.0mm	15°
Ø5.5	1.5mm	30°



2.3mm
2.0mm

Points to Consider in Abutment Selection

Considerations in Selecting an Abutment

- Esthetic requirement
- Implant angulation
- Implant location
- Fixture installation depth (Gingival height)
- Interarch distance
- Prosthesis type
- Dentist & Dental technician's preference

Impression of Implant

According to the case the impression can be taken at abutment or fixture level.

Fixture Level

1. Dual Abutment
2. Dual Milling Abutment
3. Angled Abutment (15° / 25°)
4. Direct-Casting Abutment
5. Metal-Casting Abutment
6. Temporary Abutment (Plastic & Titanium)

Abutment Level

1. Dual Abutment
2. Combi Abutment
3. Screw Abutment
4. Angled Screw Abutment (15° / 30°)

Abutment Impression Recommendation

Dual	Cementation type, screw-cementation type	Fixture level impression or abutment level impression
Combi	Cementation type	Abutment level impression
Angled	Cementation type, screw-cementation type	Fixture level impression
Screw	Screw retained type	Abutment level impression
Direct-Casting	Cementation type, screw-cementation type	Fixture level impression
Metal-Casting	Cementation type, screw-cementation type	Fixture level impression
Dual Milling	Cementation type, screw-cementation type	Fixture level impression

Minimum Height Requirement for SuperLine Prosthetic Abutment

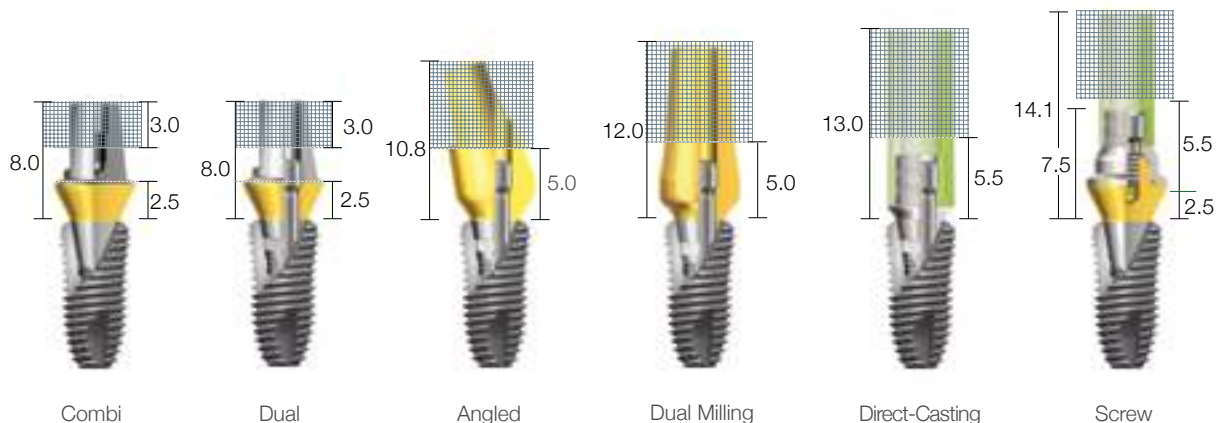

※ Diagram above indicates the minimum height required for SuperLine / IMPLANTIUM prosthetic abutment

Maximum Amount of Reduction Allotted for SuperLine

Combi Abutment

- Eliminate 3.0mm from the top level Combi abutment (laser marking: 1.5mm)
Caution _ Damage may be caused to the screw if the abutment is reduced to less than 2.5mm above the gingival height.

Dual Abutment

- Preparation of the abutment top is possible as follows.

Gingival Height	Preparable Amount
1.5mm	2.0
2.5mm	3.0
3.5mm	4.0
4.5mm	5.0
5.5mm	6.0

Angled Abutment & Dual Milling Abutment

- Required minimum abutment height: at least 5.0mm above the Fixture top.

Direct-Casting Abutment & Metal-Casting Abutment

- Required minimum abutment height: at least 5.5mm above the Fixture top.

Screw Abutment

- The Screw abutment cannot be modified, however the casting abutment can be modified for interarch distance, taking reduction into consideration of the height of the retaining screw.

Prosthetic Procedure 1

Impression Technique and Restoration Selection

Dual / Combi Abutment

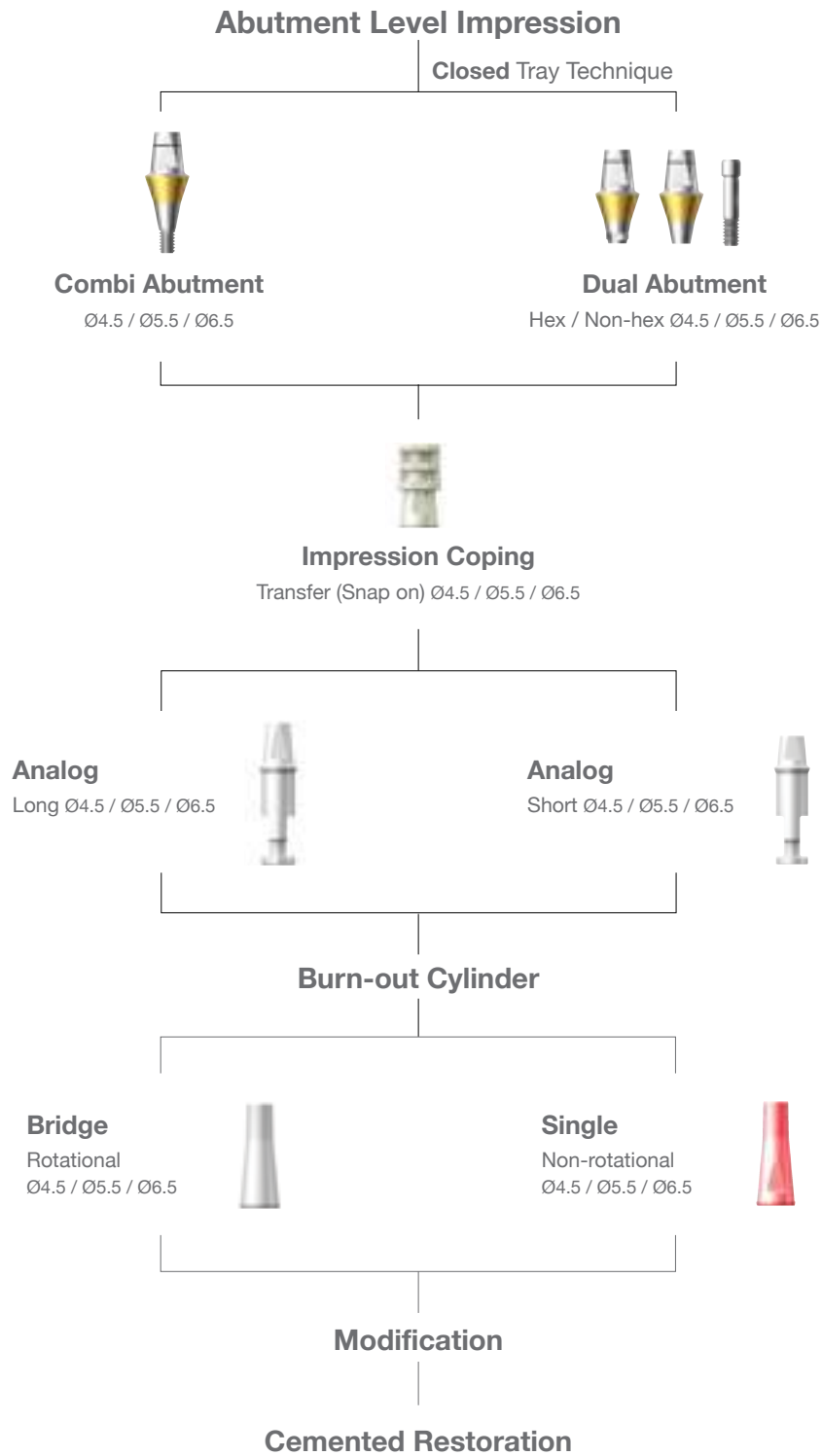

Abutment Level- Dual Abutment

[Multiple Units]

Clinical Procedure



Chairside



Remove the healing abutment after formation of soft tissue.

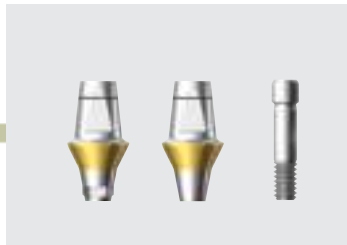

Dual Abutment (Hex / Non-hex)



Select the Dual Abutment by diameter and gingival height.



Retighten after 15 minutes
Tighten it to 25~30N·cm.



Seat the plastic cap over the abutment.

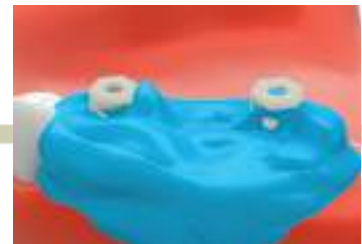

Injection of impression material.

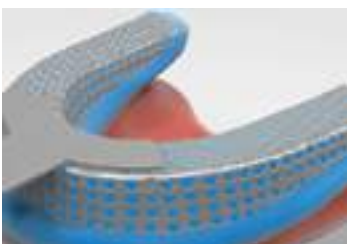

Impression taking.



Cap comes off into the impression.



Fabrication of provisional restoration
or insertion of comfort cap.

Abutment Level- Dual Abutment

[Multiple Units]

Laboratory Procedure



Lab Side



Insertion of Combi Abutment analog into impression.



Make sure analog seats securely into the impression cap (line up the flat side of analog to the flat side of the cap).



Soft tissue model.



Fabrication of master cast.



Seat burn-out cylinder security into analog.



Consider distance of opposing teeth, Modify burn-out cylinder to its proper height if needed.



Fabrication of burn-out cylinder and plastic bar in preparation for wax-up.



Completion of wax-up.



Fabrication of metal framework.

Abutment Level- Dual Abutment

[Multiple Units]



Trimming of the extended margin by using the rubber wheel.



Metal framework and reamer.



Reamer is used to eliminate "Lip" caused by 'snap-on' mechanism.



Metal Framework after removal of "Lip".



Metal framework.



Porcelain build-up.

SCRIP: Once an access hole has been created, it can be converted to a SCRIP (Screw & Cemented Retained Prosthesis).



Final prosthesis.



Access hole is made when burn-out cylinder is used to do the wax-up.



Extended margin around the metal framework due to 'snap-on' mechanism.



Trim extended margin by rubber wheel.



Metal framework and reamer.



Eliminate the lip remnant caused by 'Snap-on' mechanism by reamer.



Metal framework after removal of "Lip".



Metal framework.



Final prosthesis.

Abutment Level- Combi Abutment

[Multiple Units]

Chairside

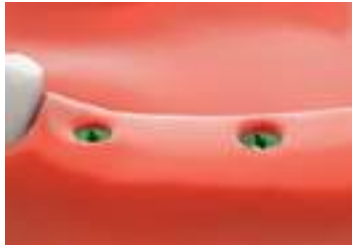

Second stage surgery (uncovering).



Following the 2nd stage surgery, soft tissue is healed around the healing abutment. healing abutment should be selected according to the size of abutment.



Choose abutment with gingival height then tighten it to 25~30N-cm. Re-tighten after 15 minutes.



Image of combi Impression coping and Abutment assembly.



Snap-on the plastic impression coping with the same sized diameter abutment.



Impression taking. Injection of impression material.

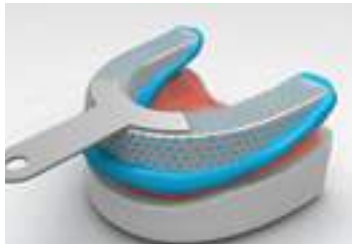

Impression taking.



Inner-surface of impression.



Fabrication of provisional restoration or insertion of comfort cap.

Lab Side



Seating of Lab analog.



Confirm analog is secured in snap cap.



Soft tissue model.



Fabrication of master cast.



Placement of burn-out cylinder.



Consider the distance of opposing teeth, modify burn-out cylinders to its proper height.

Abutment Level- Combi Abutment

[Multiple Units]



Connect the plastic bar in the middle of the trimmed burn-out cylinders to help support the resin pattern. Wax pattern may have shrinkage.



Wax-up.



Completed framework.



Trimming the extended margin with a rubber wheel.



Metal framework and reamer.



Removal of lip remnant with reamer caused by 'snap-on' mechanism.



Metal Framework after removal of "Lip".



Metal coping adaptation (Completed framework).



Porcelain build-up final prosthesis.

Chairside



* If the combi analog is trimmed due to limited inter-occlusal space in the lab, make a reduction jig. Then a slight modify of the abutment in the oral cavity may be necessary to the height of the jig.

Insertion of final prosthesis and occlusal adjustment.

Prosthetic Procedure 2

Impression Technique and Restoration Selection

**Dual / Milling / Angled / Direct-Casting / Metal-Casting /
Temporary (Plastic & Ti) Abutment**

Fixture Level Impression



Impression Coping Pick-up
Open tray technique (Complicated case)
Ø4.0 / Ø4.5 / Ø5.5 / Ø6.5



Impression Coping Transfer
Closed tray technique (Simple case)
Ø4.0 / Ø4.5 / Ø5.5 / Ø6.5



Analog
DAN 34 / DANSE



Dual Abutment
Hex / Non-hex
Ø4.5 / Ø5.5 / Ø6.5



Dual Milling Abutment
Hex / Non-hex
Ø4.0 / Ø4.5
Ø5.5 / Ø6.5 / Ø7.5



Angled Abutment
Hex / Non-hex
15° / 25°
Ø4.5 / Ø5.5



Direct-Casting Abutment
Hex / Non-hex
Ø4.5



Metal-Casting Abutment
Hex / Non-hex
Ø4.5



Temporary Abutment
Hex / Non-hex
Ø4.5 / Ø5.5 / Ø6.5

Modification

Cemented Restoration

Modification

Screw-Retained Restoration

Fixture Level [Pick-up Type]- Dual Abutment

[Multiple Units]

Clinical Procedure



Healing Abutment



Impression Coping
Pick-up Type



Fixture Level Impression
Open Tray

Chairside

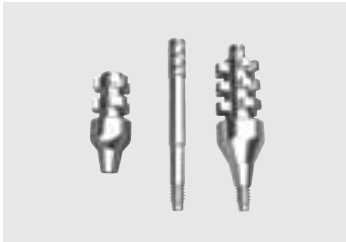

Open tray impression (pick-up)
4 diameters and two length.



Apply adhesive on open tray
(Individual tray).

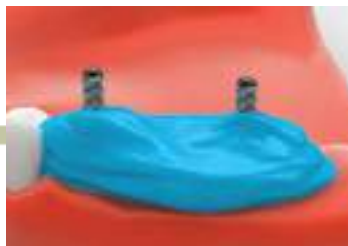

Injecting the impression material.

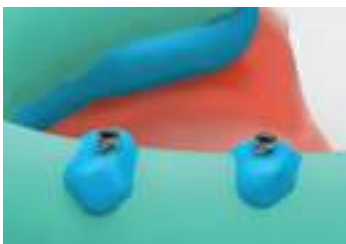

Impression taking.



Remove the screw before removing
the impression tray.



Inner surface of impression.

Fixture Level [Pick-up Type]- Dual Abutment

[Multiple Units]

Laboratory Procedure



Lab Side



Connect lab analog with impression coping.



Soft tissue model.



Fabrication of master cast.



Connect a proper abutment.



After surveying abutment milling is possible if necessary.



Fabrication of positioning jig.



Fabrication of the cap with pattern resin.



Wax-up.



Metal framework.

Fixture Level [Pick-up Type]- Dual Abutment

[Multiple Units]

Chairside



Final prosthesis.



Use positioning jig to transfer the abutment in model to oral cavity then tighten it to 25~30N·cm.
Re-tighten after 15 minutes.



Insertion of the final prosthesis and occlusal adjustment.

* In the process of seating the prosthesis, the prosthesis can be rebounded by gingival tissue. In this case it is advised to apply occlusal load on the prosthesis for 10~15 minutes.

SCR- Lab Side



Formation of access hole with long transfer coping screw.



Wax-up.



Metal framework.

SCR- Chairside



Final prosthesis.



Use positioning jig to transfer the abutment in model to oral cavity then tighten it to 25~30N·cm.
Re-tighten after 15 minutes.



Insertion of final prosthesis and adjustment of occlusion.

* In the process of seating the prosthesis, the prosthesis can be rebounded by gingival tissue. In this case it is advised to apply occlusal load on the prosthesis for 10~15 minutes.

Fixture Level [Transfer Type]- Dual Abutment

[Multiple Units]

Clinical Procedure



Chairside



Second stage surgery (Uncovering).



Soft tissue formed around healing abutment.



Transfer type impression coping.



Seating the impression coping which has the same diameter as healing abutment.



Impression of fixture level (No x-ray necessary for confirmation).



Injection of impression material.

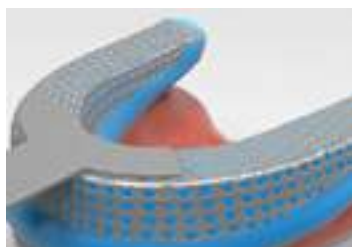

Impression taking.



Inner surface of the impression.

Fixture Level [Transfer Type]- Dual Abutment

[Multiple Units]

Laboratory Procedure



Lab Side



Impression coping and analog connection. And insert impression coping into the impression



Make sure the impression coping is fully seated into the impression.



Soft tissue model.



Fabrication of master cast.



Soft tissue condition after the of impression coping.



Measuring gingival height with depth gauge.



Selection of dual abutment of proper diameter and gingival height.



Verify by surveying the selected abutment (Milling of the abutment is possible if necessary).



Fabrication of positioning jig.

Fixture Level [Transfer Type]- Dual Abutment

[Multiple Units]



Seat the cap with pattern resin.



Completion of wax-up.



Completion of metal framework.

Chairside



Final prosthesis built up on the framework with porcelain.



Use positioning jig to transfer the abutment in model to oral cavity then tighten it to 25~30N-cm.
Re-tighten after 15 minutes.



Insertion of final prosthesis, adjust occlusion place lab wax into opening of abutment to protect screw head then cement.

SCRP- Lab Side



Make an access hole in the resin cap by using the long open tray transfer screw.



Completed wax-up.



Metal framework.

SCRP- Chairside



Final prosthesis.



Use positioning jig to transfer the abutment in model to oral cavity then tighten it to 25~30N-cm.
Re-tighten after 15 minutes.



Insertion of final prosthesis and occlusal adjustment. Place wax into opening of the abutment prior to sealing with composite.

* In the process of seating the prosthesis, the prosthesis can be rebounded by gingival tissue. In this case it is advised to apply occlusal load on the prosthesis for 10~15 minutes.

Fixture Level [Transfer Type]- Dual Milling Abutment

[Single Units]

Clinical Procedure



Healing Abutment



Impression Coping Transfer Type



Fixture Level Impression

Chairside



Placement of healing abutment.



Placement of impression coping with the same diameter as healing abutment.



Injecting of impression material.

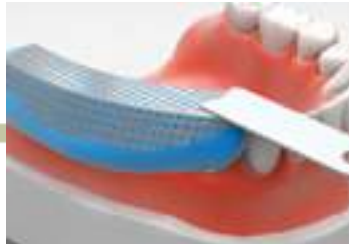

Impression taking.



Impression coping formation on the inside of impression is observable (Traces of impression coping on the inner surface of impression).

Laboratory Procedure



Lab Analog Connection



Dual Milling Abutment Connection



Modification



Crown Wax-up



Final Restoration Cementation

Fixture Level [Transfer Type]- Dual Milling Abutment

[Single Units]

Lab Side



Impression coping and analog connection. And insert impression coping into the impression.



Soft tissue model.



Master cast.



Selection of appropriate dual milling abutment.



Abutment after milling process.



Fabrication of positioning jig.



Fabrication of pattern resin cap.



Completion of wax-up.



Metal framework.



Final prosthesis.



Use positioning jig to transfer the abutment in model to oral cavity then tighten it to 25~30N-cm.
Re-tighten after 15 minutes.



Insertion of final prosthesis and occlusal adjustment.

* In the process of seating the prosthesis, the prosthesis can be rebounded by gingival tissue. In this case it is advised to apply acclusal load on the prosthesis for 10~15 minutes.

Fixture Level [Pick-up Type]- Angled Abutment

[Single Units]

Clinical Procedure



Chairside

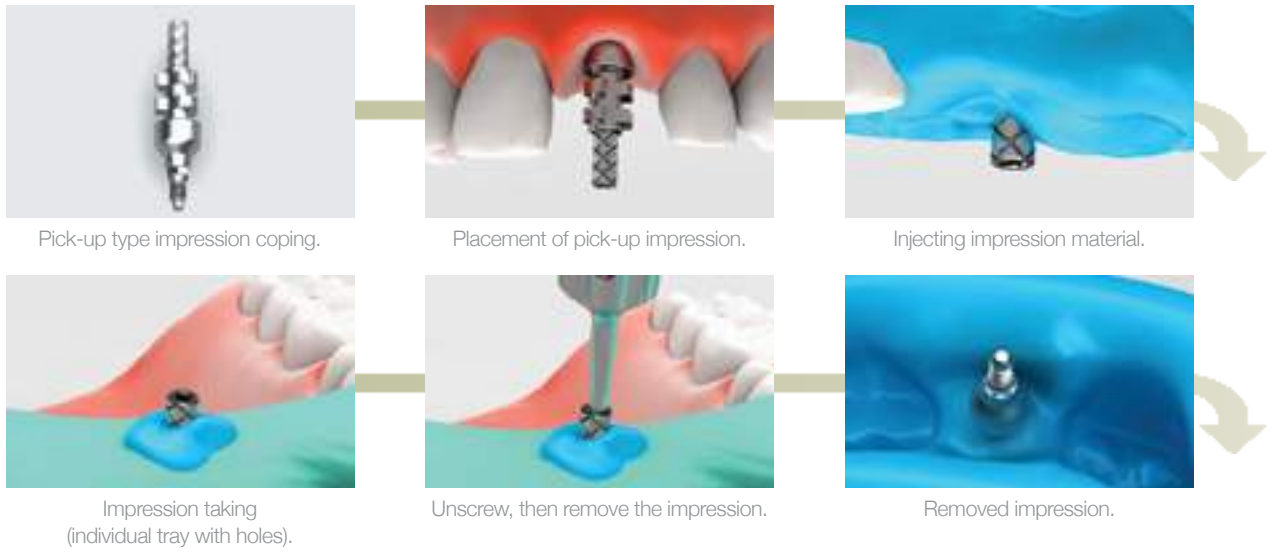

Laboratory Procedure

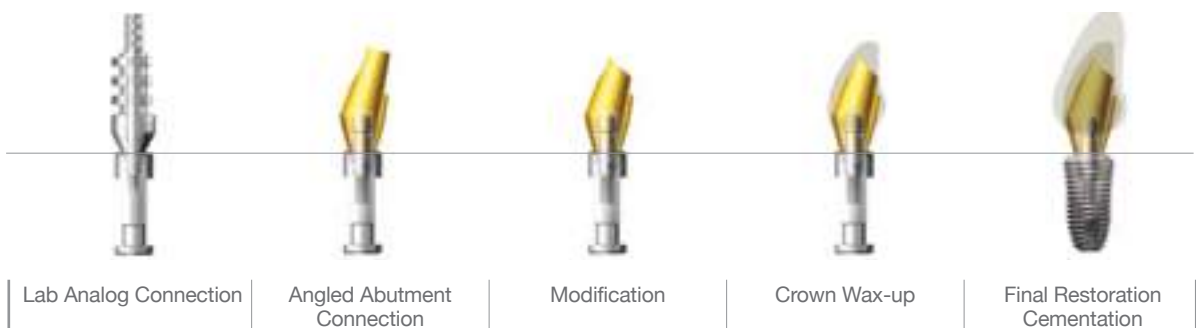

Fixture Level [Pick-up Type]- Angled Abutment

[Single Units]

Lab Side



Impression coping with analog connections.



Soft tissue formation and fabrication of master model.

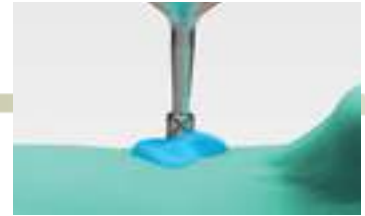

Unscrew then separate impression from the model.



Master cast.



Select an angled abutment.



Modification of angled abutment & fabrication of positioning jig.



Fabrication of pattern resin cap.



Wax-up.



Metal or zirconia framework.

Chairside



Final prosthesis.



Insertion of the angled abutment using positioning jig.



Insertion of final prosthesis and occlusal adjustment.

Fixture Level- Direct-Casting Abutment

[Single Units]

Laboratory Procedure



Lab Side

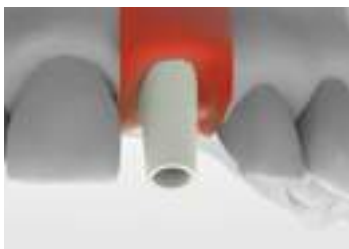

Placement of Direct-casting abutment.



Completed custom abutment.



Fabrication of positioning jig.



Fabrication of pattern resin cap.

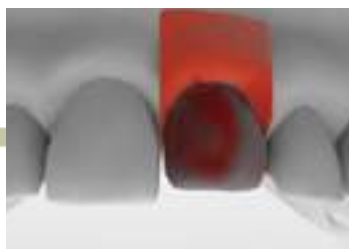

Wax-up.



Metal framework.

Chairside



Final prosthesis.



Insertion of custom abutment using positioning jig.



Insertion of final prosthesis and occlusal adjustment.

Fixture Level- Metal-Casting Abutment

[Single Units]

Laboratory Procedure



Lab Side

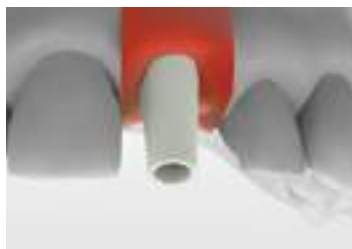

Placement of metal-casting abutment.

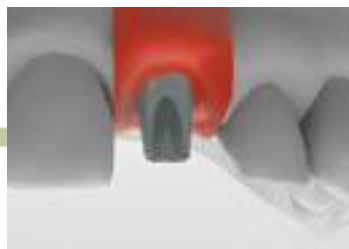

Completed custom abutment.



Fabrication of positioning jig.



Fabrication of pattern resin cap.

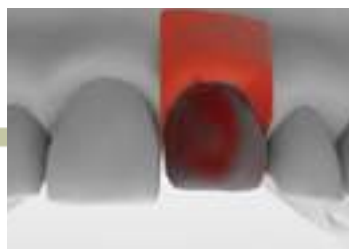

Wax-up.



Metal framework.

Chairside



Final prosthesis.



Insertion of custom abutment using positioning jig.



Insertion of final prosthesis and occlusal adjustment.

Fixture Level [Pick-up Type]- Temporary Abutment

[Single Units]



Ti-Temporary Abutment



Plastic Temporary Abutment

<Using Ti Abutment>



<Using Plastic Abutment>



Considering the opposing teeth before seating the temporary abutment, trim off the abutment as needed and complete the temporary abutment prosthesis with direct resin.

Prosthetic Procedure 3

Impression Technique and Restoration Selection

Screw Abutment

Abutment Level Impression



Screw Abutment

Ø4.5 / Ø5.5

Open Tray Technique



Impression Coping Pick-up

Bridge / Single Ø4.5 / Ø5.5

Closed Tray Technique



Impression Coping Transfer

Bridge / Single Ø4.5 / Ø5.5

Analog

Ø4.5 / Ø5.5



Burn-out Cylinder

Ø4.5 / Ø5.5



Gold Cylinder

Ø4.5 / Ø5.5



Metal Cylinder

Ø4.5 / Ø5.5



Titanium Cylinder

Ø4.5 / Ø5.5



Bridge
(Non-hex)

Single
(Hex)

Bridge
(Non-hex)

Single
(Hex)

Bridge
(Non-hex)

Single
(Hex)

Bridge
(Non-hex)

Single
(Hex)

Polishing Protector

Ø4.5 / Ø5.5



Temporary Restoration



Ti-Retaining Screw

Screw-Retained Restoration

Abutment Level [Transfer Type]- Screw Abutment

[Multiple Units]

Clinical Procedure

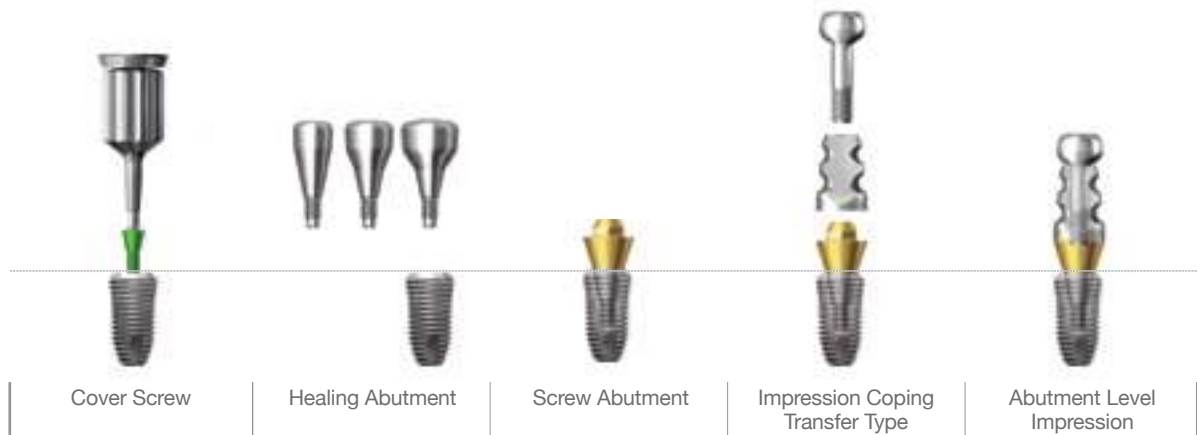

Chairside



Select and seat an appropriate screw abutment with delivery holder.

Tighten it to 25~30N·cm. Re-tighten after 15 minutes with screw abutment adaptor.

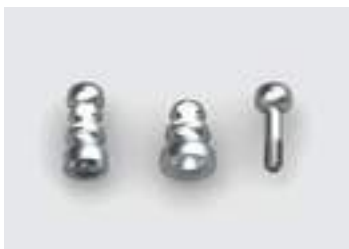

Screw abutment transfer copings (abutment level).

Placement of impression copings.

Injecting impression material.

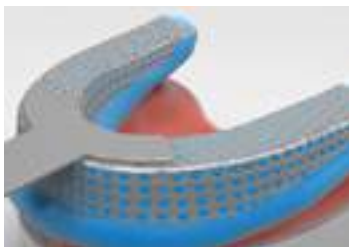

Impression taking.

Inner-surface of impression.

Placement of comfort cap on screw abutment.

Abutment Level [Transfer Type]- Screw Abutment

[Multiple Units]

Laboratory Procedure



Lab Side



Connecting impression coping with screw abutment analog.



Position impression coping and analog assembly in the exact location of the impression.



Soft tissue model.



Fabrication of master cast.



Removal of impression coping.



Connect the screw abutment cylinder then tighten it with Ti-retaining screw.



Consider the distance with opposing teeth, then trim cylinder to its appropriate height.



Connect the plastic bar in the middle of trimmed burn-out cylinders to help support the wax pattern. Wax pattern may have shrinkage.



Wax-up.

Abutment Level [Transfer Type]- Screw Abutment

[Multiple Units]



Metal framework.



Removal of lip remnant in the interior of metal framework by using reamer.



Completion of metal framework.



Completion of porcelain.



Insertion of final prosthesis and occlusal adjustment. Tighten with Ti-retaining screw (10N·cm).

Cementation Repair Method (SCRIP)

[Screw & Cement Retained Prosthesis]

In light of Implant Prosthesis:

- A screw type restoration helps to simplify prosthesis repair, including insertion and removal of the prosthesis if necessary.
- Cement type restoration tend to have a stable occlusion and may enhance the adaptability. However the weak point is that it cannot be removed after permanent cementation.
- A dual abutment can be cemented or screw retained.
- Combi abutments are cement retained and no occlusal hole is necessary.

In case of screw loosening or if prosthesis repair is needed



In case of the following:
screw loosening Prosthesis repair.



In order to unscrew, form access hole
on the occlusal surface with bur.



Unscrew, then remove the prosthesis
from the oral cavity.



Both cemented prosthesis and
abutment are removed.



Finish the repair then seat it inside the
oral cavity.



Tighten the prosthesis with
25~30N·cm by a screw driver
* It is recommended that the abutment screw is
retightened after 15 minutes.



First, fill the access hole with cotton.



Finally fill the access hole with resin.



Final prosthesis.

Cementation Repair Method (SCRIP)

[Screw & Cement Retained Prosthesis]

Prosthesis separation from abutment due to cement loss



Remove the screw completely with screw driver and remove prosthesis from the patient's mouth.



Apply cement to the prosthesis.



Place it back into the patient's mouth.



After the cement setting, unscrew and remove the excessive cement.



Finish the repair and seat it inside the patient's mouth.



Tighten the prosthesis with 25~30N-cm with a screw driver.

Adding to the interproximal contact surface due to prosthesis loosening



For instance of getting additional contact due to contact loosening.



Form access hole using bur.



Unscrew, then remove the cemented prosthesis with abutment in the oral cavity.

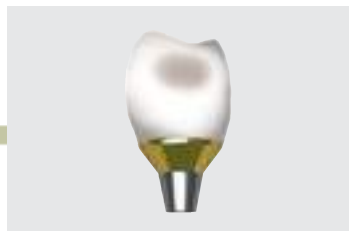

Contact adding with resin on the prepared under space.



Insert the prosthesis in the oral cavity and screw it in. Afterwards, perform light curing, then polish the contact area.

* It is recommended that the abutment screw is retightened after 15 minutes.



Position the prosthesis in the mouth and tighten the screw with 25~30N-cm, then fill up the access hole.



Prosthetic Procedure 4

Impression Technique and Restoration Type

Overdenture Procedure

Positoner / Ball / Magnetic Attachment

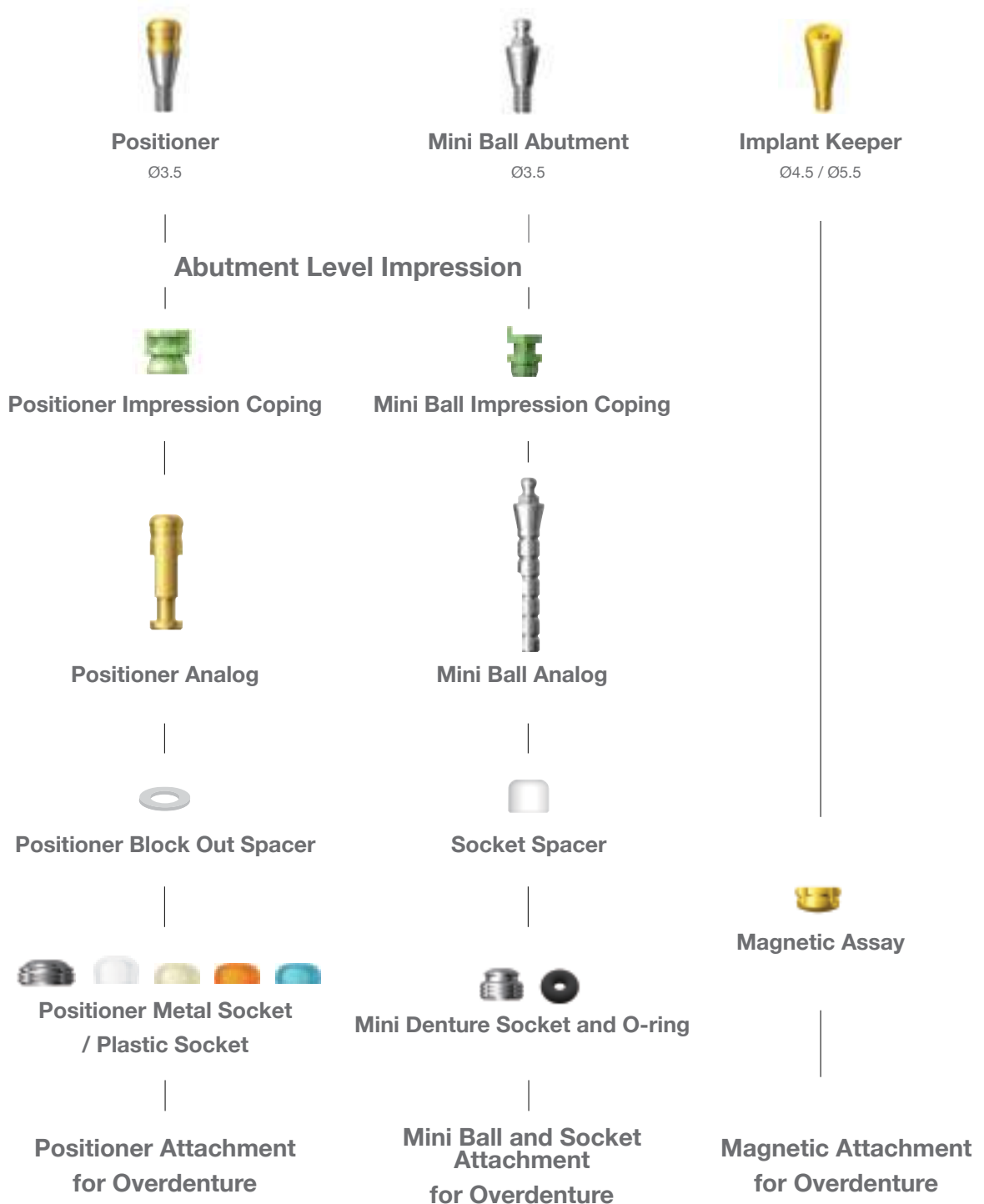

Positioner

Chairside



Connect the positioner abutment onto the fixture.

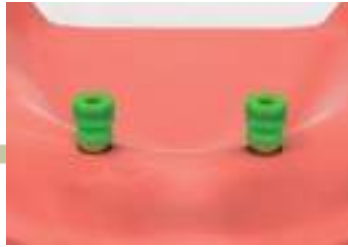

Affix the impression coping on the positioner abutment.

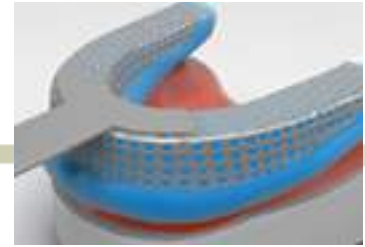

Take Impression for the production of individual tray.



Produce the individual tray for denture impression.



After connecting the positioner abutment and the impression coping together, apply the impression material.



Take the final impression with the prepared individual tray.

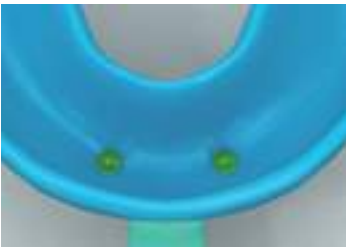

After the impression material is set, discard the individual tray.

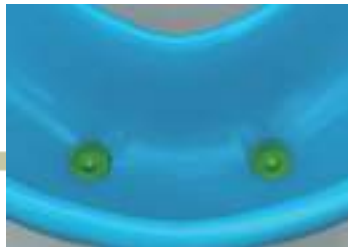
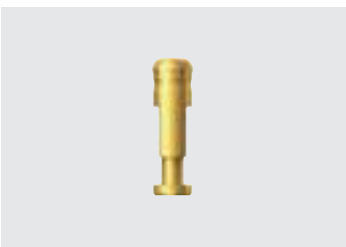

Image of the set final impression (with impression coping).

Lab Side



Positioner analog.



Insert the positioner analog into the embedded impression coping.



Create the master model.



"Block out" procedure to achieve the space required for the metal socket.



Fabrication of denture with conventional method.

Positioner

Case 1

Chairside



Secure spaces for the female sockets.



Place the "block out spacer" on the positioner abutment in the patient's mouth.



Connect the metal socket onto the positioner abutment.



Apply a small amount of resin into the space created for the metal socket.



Position the denture in the mouth and wait until the resin is completely set.



Remove the white plastic socket (100gf) using the positioner tool and assemble with the regular plastic socket giving the desired retention force (300, 500 or 1000gf).



Remove the denture after the resin is fully set. Image of the denture with the metal socket.



Remove the block out spacer from the patient's mouth.



Polish and the overdenture is complete.

Case 2

Chairside



Create holes for the placement of the metal sockets.



Place the "block out spacer" on the Positioner Abutment in the intraoral.



Connect the metal socket onto the Positioner Abutment.



Examine the interference between inner surface of the holes and the female sockets.



Apply the resin into the holes and wait until it is completely set.



Remove the white plastic socket (100gf) using the Positioner tool and assemble with the regular plastic socket giving the desired retention force (300, 500 or 1000gf).



Apply additional resin around the metal socket where there is a shortage of resin.



Apply resin around the metal socket.



Polish and the overdenture is complete.

Ball Attachment

Chairside



Connect the Ball Abutment onto the fixture.



Affix the impression coping on the ball type fixture.

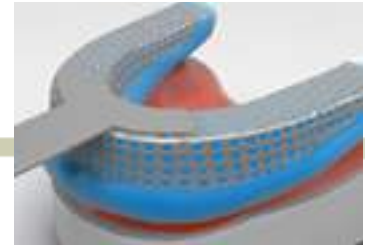

Take Impression for the production of individual tray.



Produce the individual tray for denture impression.



Apply the impression material.



Take the final impression with the prepared individual tray.



After the impression material is set, discard the individual tray.

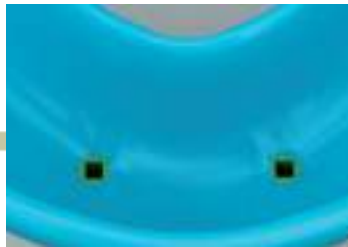

Image of the set final impression (with impression coping).

Lab Side



Ball Analog.



Insert analogs into the embedded impression coping.



Create the master model.



Socket spacer.



Fabrication of denture with conventional method.

Ball Attachment

Case 1



Secure spaces for the female sockets.

Chairside



Connect the female sockets to the ball abutments in the intraoral.



Apply small amount of the resin into the secured area.



Position the denture in the mouth and wait until the resin is completely set.



Female sockets are placed in the denture.



Polish and the overdenture is complete.

Case 2



Create holes for the placement of the female sockets.

Chairside



Connect the female sockets to the ball abutments in the intraoral.



Examine the interference between inner surface of the holes and the female sockets.



Apply the resin into the holes and wait until it is completely set.



Place the female sockets.



Apply resin around the female sockets.



Polish and the overdenture is complete.

Magnetic Attachment

Chairside



After healing abutment removal.



Connect implant keeper with fixture and tighten it with 25~30N·cm.



Implant keepers connected with the fixtures.



Position the magnetic assay on the implant keeper.



Secure spaces for the magnetic assays.



Examine the interference between inner divot of the denture and the magnets.

Case 1



Apply resin on the divot of the denture's inner surface.



Position the denture into the mouth and wait until the resin is completely set.



Magnetic assays are placed in the denture.



Apply some of resin around the magnetic assays.



After the resin is completely set, remove excess. Polish and the overdenture is complete.

Magnetic Attachment

Case 2



Create holes for the placement of the magnets.



Examine the interference between inner surface of the holes and the magnets.



Position the denture in the mouth and apply small amount of resin into the hole.



Wait until the resin is completely set.



After setting, remove denture from the mouth.



Add the resin around the magnets.



Polish and the overdenture is complete.

DENTIUM LONG-TERM CLINICAL DATA

2002

2003

2004

2005

2006

2007

2008



2002. 05. 17
Pre-op



2002. 09. 04
Post-op



2003. 03. 15
Final prosthesis

Dentium

For Dentists By Dentists

2009

2010

2011

2012

2013

2014

2015

11 YEARS



2008. 04. 14
5 years



2013. 12. 05
11 years

over
10 years
of Long
term
data

OVER A **DECADE** OF
COMMITMENT TO
THE **BEST PRODUCTS**
FOR DENTISTS AND
PATIENTS

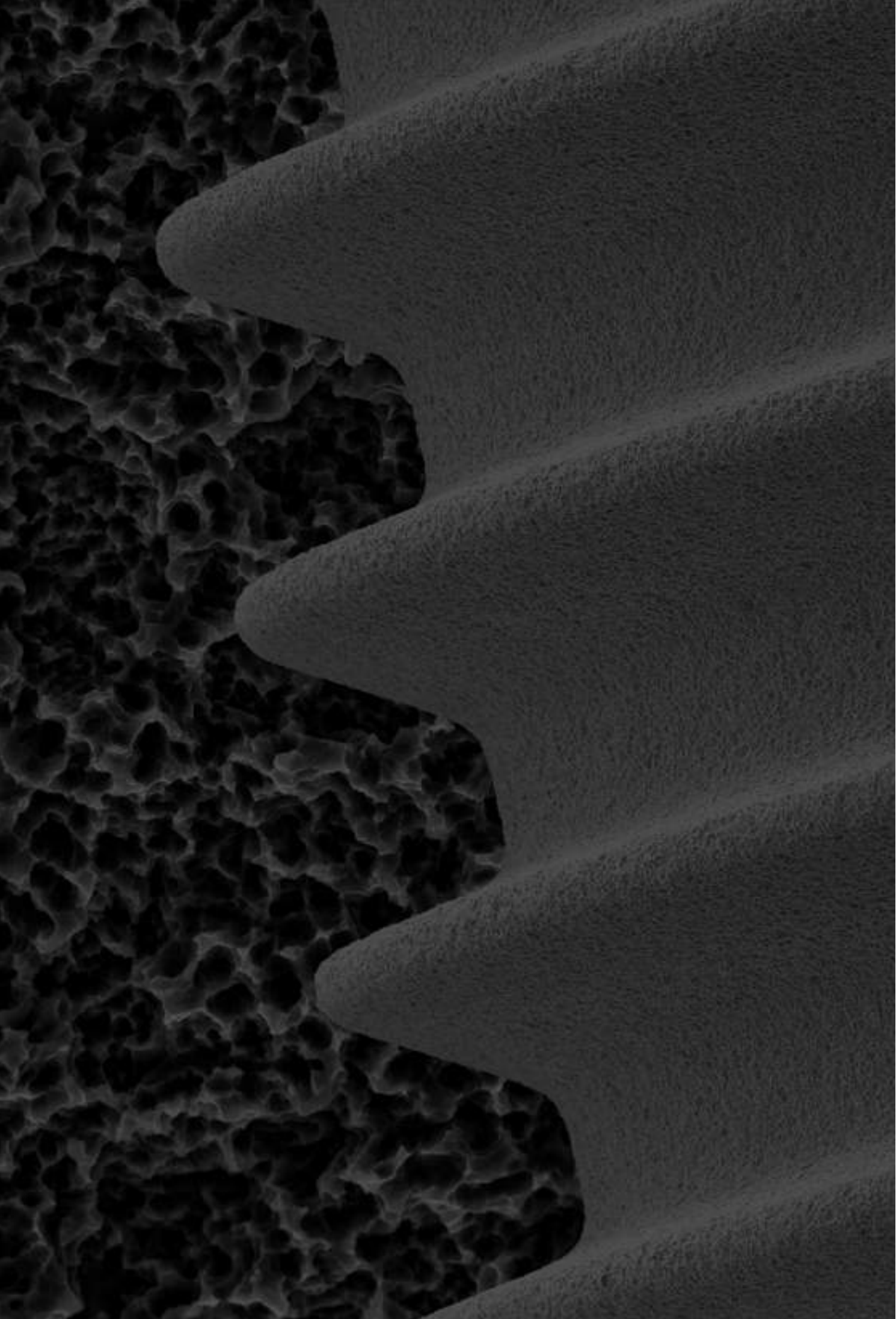

Dentium
For Dentists By Dentists

SuperLine & Implantium

Product/Manual Catalog

Dentium
For Dentists By Dentists

Specifications are subject to change without notice.
Some products listed in this catalog are not available in the market due to pending approval.

HEAD OFFICE

209 Gyeonggi R&DB Center, 105 Gwanggyo-ro, Yeongtong-gu, Suwon-si, Gyeonggi-do, Korea [443-270]

T +82-31-888-5441 F +82-31-888-5430

E-mail biz_mail@dentium.com / www.dentium.com

SIPMO-1503 [Rev.2]

