

- Exposed Mounting
- Stainless Steel **Bradex**[®]

Product Materials

CLOTHES HOOK: 12 gauge stainless steel with exposed surfaces in satin finish. All welded construction.

MOUNTING PLATE: 12 gauge stainless steel with exposed surfaces in satin finish. All welded construction.

Installation

Verify all rough-in dimensions prior to installation. Secure to wall with mounting screws (included) at holes provided.

Guide Specification

Clothes hook shall be 12 gauge stainless steel with exposed surfaces in satin finish.

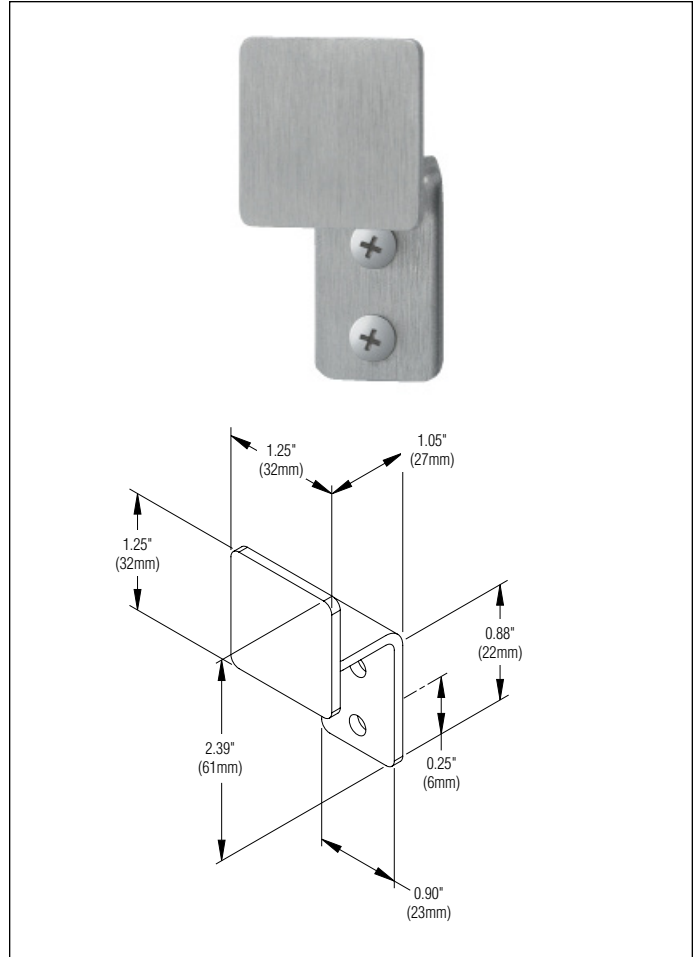

Orders composed of products indicated as **Bradex**[®] will be available to ship in three days after receipt of order at the factory. There is no pricing penalty for this service from Bradley.

Page 2 of 1 7/24/2012
This information is subject to change without notice.
Bradley_Hook_917

© 2015 Bradley
P.O. Box 309, Menomonee Falls, WI 53052-0309
800 BRADLEY (800 272 3539) +1 262 251 6000
bradleycorp.com