



# Signature Bed Installation Guide and Technical Specifications



# Contents

1. Explanations of Symbols	2
2. Installation and Commissioning	3
3. Bed Operation and Maintenance	23
4. Troubleshooting	27
5. Safety Instructions	28
6. General Information	33
7. Servicing	36
8. Technical Specification	39
9. Service Life and Disposal	46
10. Guarantee	47
11. Opera Warranty Terms and Conditions	47

# 1. Explanations of Symbols



Read information with this symbol carefully and urgently follow instructions. This information is safety-relevant.

---



This symbol indicates hazards due to electrical voltage. There is mortal danger!

---



This symbol indicates general hazards. There is danger to life and health.

---



Conformity mark in accordance with the Medical Device Directive (93/42 EEC).

---

**IPX4**

The electrical equipment is splash-proof.

---



Symbol for Protection Class II device, double shock-proof.

---



Symbol for type B device according to DIN EN 60601-1.

---



This care bed may only be used indoors

---



This product must be disposed of in a separate refuse collection in the European Union. Do not dispose of as normal domestic waste.

---



Symbol for direct current.

---



Symbol for alternating current.

---



Maximum permissible load.

---



Maximum patient weight.

---



Read instructions

---

## 2. Installation and Commissioning

# 2. Installation and Commissioning

(A) Head/Footboard\*\*\*\* x 2



(F) Side Rail x 4



(G) Side Skirt x 2



(B) Mattress Platform Securing Bolt\* x 16



(C) Side Skirt Fixing Bolt and Insert Nut x 8



(D) Side Rail Channel Fixing Bolt\*\* x 4



(E) Chassis Securing Bolt x 4



\* Eight of these are already fitted to the Mattress Platform Backrest Section

\*\* These items are already fitted to the Head/Footboards

\*\*\* These items are already fitted to the Mattress Platform Sections

\*\*\*\* Foot and headboards styles vary

## 2. Installation and Commissioning

### (H) Mattress Backrest platform

N.B. Easily identifiable because it has both an actuator and the black control box.



### (I) Mattress Legrest platform

N.B. Easily identifiable because it only has one actuator.



### (J) Bed Chassis

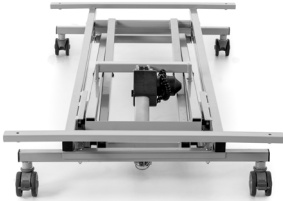

### (K) Mattress Retainers\*\*\* x 4



### (L) Side Rail End Cap x 8



### (M) Side Rail Runner x 4



### (N) Handset



### (O) Power Transformer



### Before you begin, you will also need:

- Wall space with a plug socket nearby
- Tools: 4mm & 6mm Allen Key, A cross head screw driver, Pair of scissors

## 2. Installation and Commissioning



**Read before you begin!** We recommend that two people install this bed due to the weight of individual parts.

1

### Position the bed

Move the bed into the centre of the room.

Place the side rail and side skirt boxes to one side.



2

### Place accessories to one side

Detach the following accessories and place to one side:

(B) Mattress Platform Securing Bolt x 16

(C) Side Skirt Fixing Bolt and Insert Nut x 8

(E) Chassis Securing Bolt x 4

(L) Side Rail End Cap x 8

(M) Side Rail Runner x 4

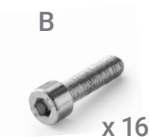

3

## Remove head/footboards and mattress platforms from the transportation bracket

Loosen the thumb screws (1) on each side of the transportation bracket, and slide the head and footboards (A) out of the bracket. Place the detached boards to one side. Lift the mattress platform sections out of the transportation bracket, place these to one side with the actuator motors facing up/on top of the sections.

**⚠ ATTENTION: The bed parts are heavy, please observe the general rules of manual handling to prevent strain and injury.**

Transportation bracket thumb screws



Head/footboard detached

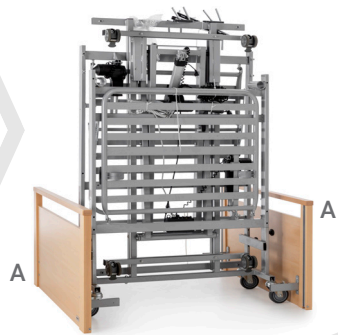

Mattress platform sections detached, leaving the chassis in the transportation bracket



Mattress backrest platform with the actuator motor on top

## 4 Position the bed chassis

With two people lower the bed chassis (J) down on to the floor. Next, carefully lift the chassis off the transportation bracket and place down. Move the transportation bracket to one side. Once the chassis is positioned, brake all four castors of the chassis by pressing down on the brake peddles.

**⚠ ATTENTION: The bed chassis is heavy, please observe the general rules of manual handling to prevent strain and injury.**

Chassis lowered down in the transportation bracket



Chassis with transportation bracket removed



Brake On



Brake Off



5

## Secure the actuator motor

Lay down the mattress legrest platform (1) with the actuator motor facing up (2).

On the actuator securing bracket (3) pull back the metal guard and remove the pin (4). Align the holes in the actuator to the bracket (this is where the pin was). Insert the pin through the holes and pull the metal guard back over the pin to secure the actuator in place. Repeat for the mattress backrest platform.



Actuator not aligned



Pin removed and holes aligned



Pin inserted with guard in place



Pin inserted

6

## Place the backrest mattress platform on the bed chassis

Lift the mattress backrest platform (H) onto the head end of the bed chassis (as per the photos below). Ensure that the mattress backrest platform is not placed above the height adjustment actuator/motor on the chassis.

Position the mattress backrest platform so that the securing bar (5) at the head end of the chassis is placed into the U bracket of the backrest (6).



**ATTENTION:**  
Do NOT place the mattress backrest backrest section over the actuator/motor on the bed chassis.

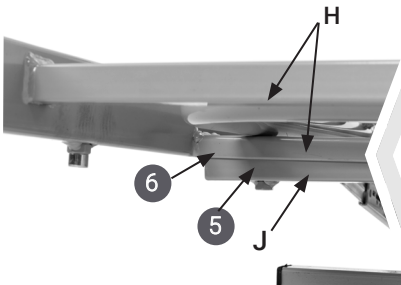
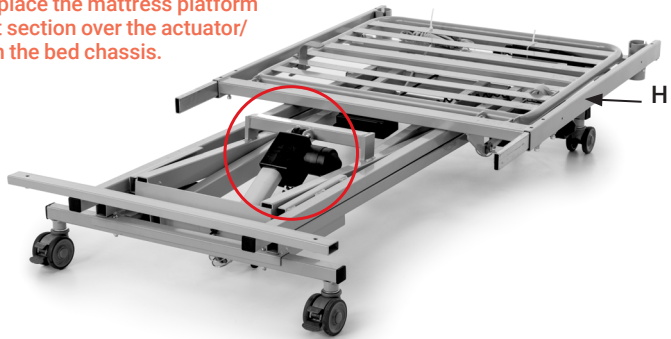

U bracket placed over security bar

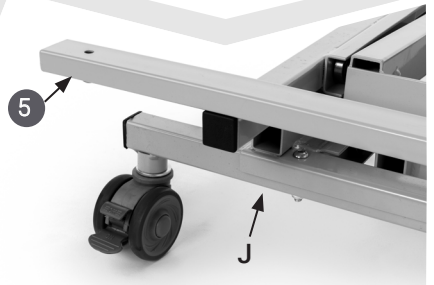

Security bar

7

## Fix the backrest mattress platform

Manually lift the mattress backrest platform to access the pre-drilled holes in the security bar of the chassis and the U bracket of the mattress backrest platform. Feed the chassis securing bolts (E) into the holes and through to the chassis, tighten with a 6mm Allen key. Repeat this on the other side of the bed.

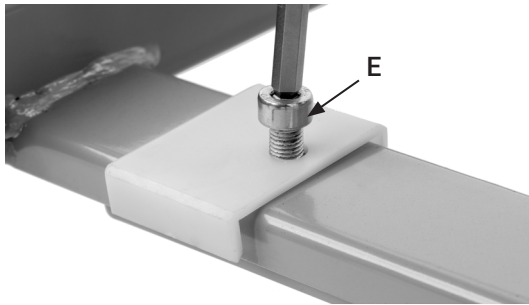

8

## Plug in the actuators to raise the bed

Plug in the height adjustment actuator (7), backrest actuator (8) and the handset (9) into the correct color-coded sections of the control box, as shown below. The control box is under the mattress backrest platform.

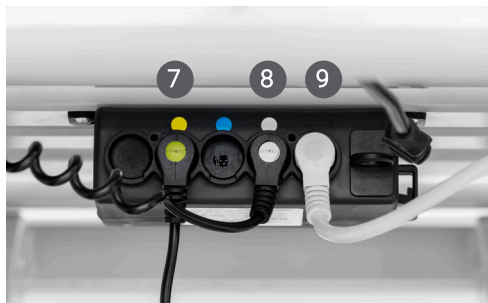

9

## Raise the bed

Plug the bed into a mains power supply and raise the bed with the handset\*, raise the bed to a suitable working height.



**ATTENTION:**  
Ensure that there are no cables caught in the scissor-action mechanism when adjusting the bed height.



\*Please see page 24 on how to use the handset.

10

## Connect the mattress platforms and secure the legrest section

Lift the mattress legrest platform (I) onto the chassis (J). Align the metal prongs in the mattress legrest platform to the channels in the mattress backrest section (H). Feed the metal prongs into the channels until the mattress platform sections are joined.

Make sure that the mattress legrest platform is placed on to the securing bar, and tighten the mattress platform securing bolts (10) to secure the mattress platforms together. After this, repeat the process in step 7 to secure the legrest mattress platform to the chassis.

Legrest platform inserted into backrest platform

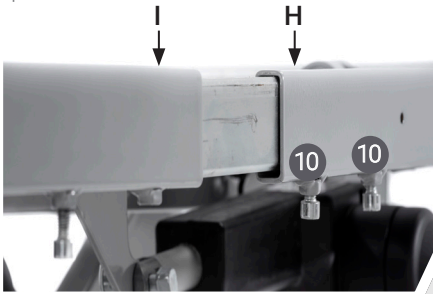

Mattress platform securing bolts

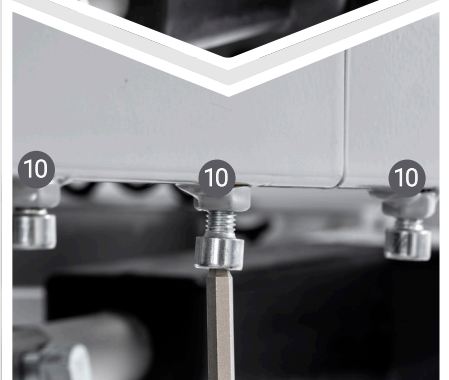
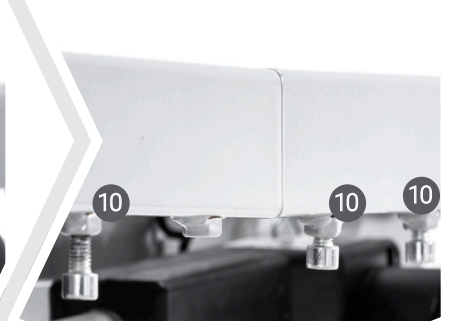

Mattress platform securing bolts tightened

11

## Connect the remaining actuator

Plug the legrest actuator into the control box (11). Take two cross head screws and attach the control box cover to the control box, with a cross head screw driver.



12

## Attach the head and footboards

Lift the headboard so that the two metal mounting brackets at either side are in line with the two channels at the head end of the mattress platform. Slide the metal mounting brackets in until the headboard is aligned with the mattress platform. Secure the headboard in place with the mattress platform securing bolts (B) and tighten with a 6mm Allen key. Repeat these steps to attach the footboard.

Mattress platform side channel

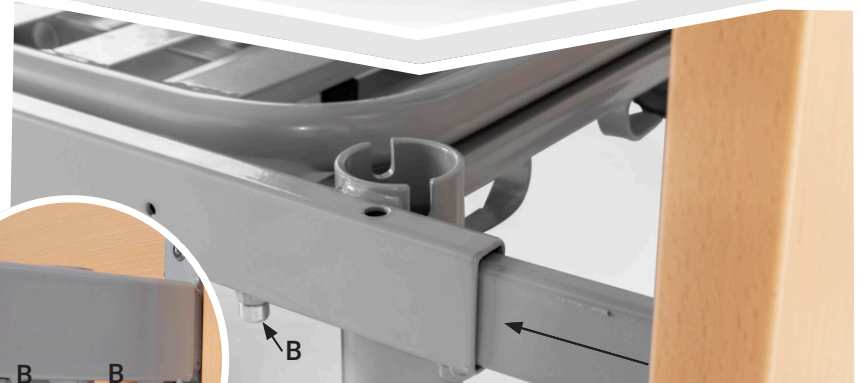
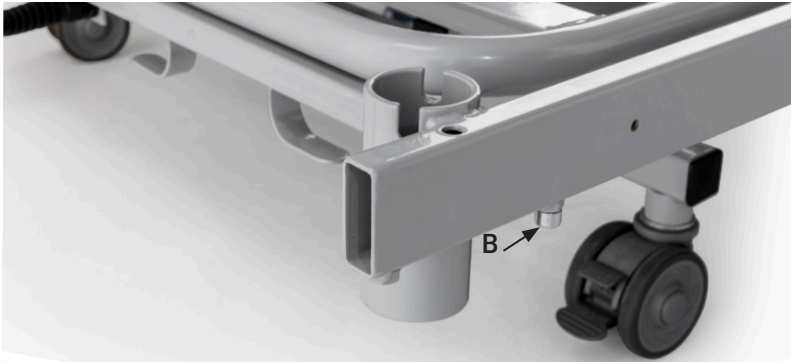

Headboard mounting bracket being inserted into the mattress platform side channel

13

## Fit the side skirts

Unpack the two side skirts (G). Place the side skirt insert nuts (C) into the pre-drilled holes of the inner side of the mattress platform channel (see photos below). Using the side skirt fixing bolts (C) and a 4mm Allen key, attach the side skirts to the mattress platform side channel. Insert all 8 bolts through the side skirt and into the insert nuts before fully tightening.

To attach the Signature Comfort side skirts please go to page 22.

Mattress platform channel pre-drilled holes circled



Insert nut inserted into the inside of the mattress side channel

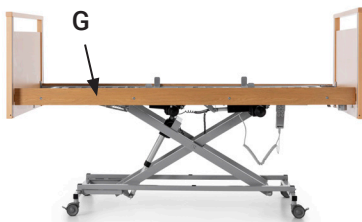

Finished bed without side rails

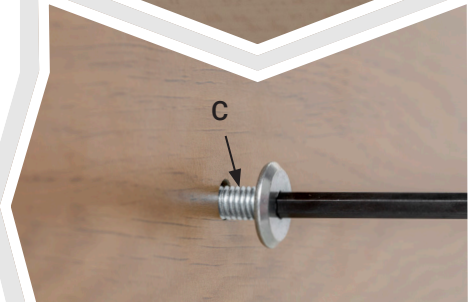

Side skirt fixing bolt inserted into the side skirt



14

## Fit the side rail end caps

Unpack the side rails (F) from their box. Lay all four side rails on to the floor. Fit the plastic end caps (L) to both ends of the side rails. To fit the plastic end caps put the side caps on the bottom edge of the side rail (see below) and push the side rail end cap on.



15

## Insert the side rail runners into the headboard

Unscrew the side rail channel fixing bolt (D) on the headboard and slide the side rail runners (M) up the channel. Screw the fixing bolt (D) back in place.

Side rail channel fixing bolt being removed



Side rail runner inserted



Side rail channel fixing bolt inserted and tightened

16

## Fit the side rails to the headboard

Fit the wooden side rails (F) onto the side rail runner (M) by sliding the rail runners all the way into the side rail end caps (L) and into the wood of the side rails. The side rail runners go into the top and bottom holes of the side rail and side rail end caps.

Side rail fitted onto side rail runner

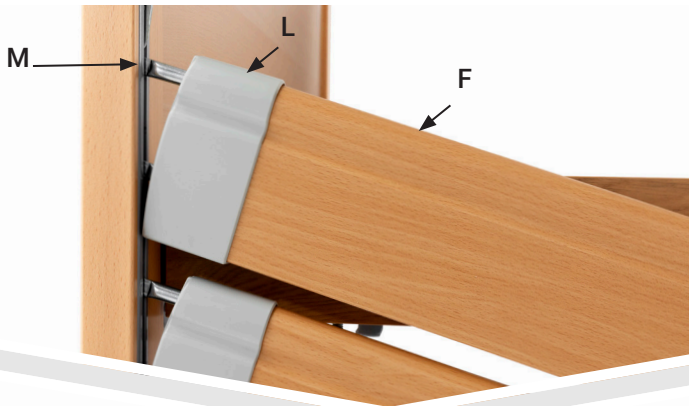

17

## Complete the side rail fitting

Remove the side rail channel fixing bolt (D) from the footboard. Attach the side rail runner to the foot end of the side rails as shown in step 16. Slide the side runner into the channel and bring it up until it clicks into place at the top channel. Lift the rails up to their highest position and screw the channel bolts back into place. Go back to step 15 and repeat the process for the other side of the bed.

Side rail attached to side rail runner

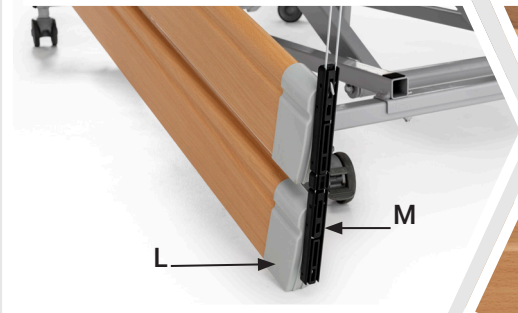

Side rail runner inserted into channel



Side rail in highest position



Side rail runner fully inserted with channel bolt in place

18

## Clip on the mattress retainers

Clip in place the mattress retainers (J), 2 slats down from the top of the backrest, and 2 slats up from the bottom of the legrest. Repeat for the other side of the bed.

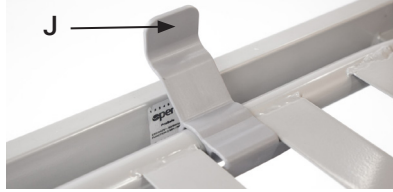

19

## Test functions

Test that the controls on the bed are working correctly, perform the following steps:

- I. Test the height adjustment
- II. Test the backrest elevation
- III. Test the legrest elevation

Please refer to page 24 on how to use the handset to perform the above tests.



**ATTENTION:** Ensure that there are no cables caught in the scissor-action mechanism when adjusting the bed height.

20

### Position the bed

Move the bed into the desired position (unbrake the castors before moving). Position the bed and apply the brakes to the castors.

Place the mattress onto the bed, make sure that the mattress is secure and all mattress holders are in place.

21

### Confirm compliance

Mattresses used with the Opera Signature Profiling Beds must meet the following requirements:

- The side rail height from the top of the mattress in an uncompressed condition and top edge of the side rail must be a minimum of 220mm.
- The mattress must meet the requirements outlined in the technical specifications.

22

## Instructions for attaching the Signature Comfort side skirts

Unpack the two comfort side skirts.

Use the handset to lift up the mattress backrest platform and the mattress legrest platforms to access the pre-drilled holes that are on the inside of the mattress platform side channel.

Line up the four holes in the side skirts to the four holes inside of the mattress platform side channels. Using the side skirt fixing bolts (C) and a 4mm Allen key, insert all 8 bolts into the side skirts from the inside of the bed, tighten the side skirt fixing bolts when all bolts are in place.

Repeat step 12 to attach the head and footboards.

Signature Profiling Bed



Bed electronically adjusted to give access to the side skirt fixing bolt holes



Signature Comfort Profiling Bed example



Side skirt holes lined up with the side channel holes

# 3. Bed Operation and Maintenance

## 3.1 Overview



- 1. Height adjustment actuator
- 2. Electrically adjustable backrest
- 3. Electrically adjustable legrest
- 4. Mechanically adjustable legrest
- 5. Handset with locking key
- 6. Backrest actuator
- 7. Legrest actuator
- 8. Headboard
- 9. Footboard
- 10. Mattress holders
- 11. Side rails
- 12. Side rail channel
- 13. Chassis
- 14. Side skirt
- 15. Castors with mechanical brake



## 3.2 Handset with Locking Function

The motorised bed functions can be operated via the handset. All functions can be locked with the nurses' key.

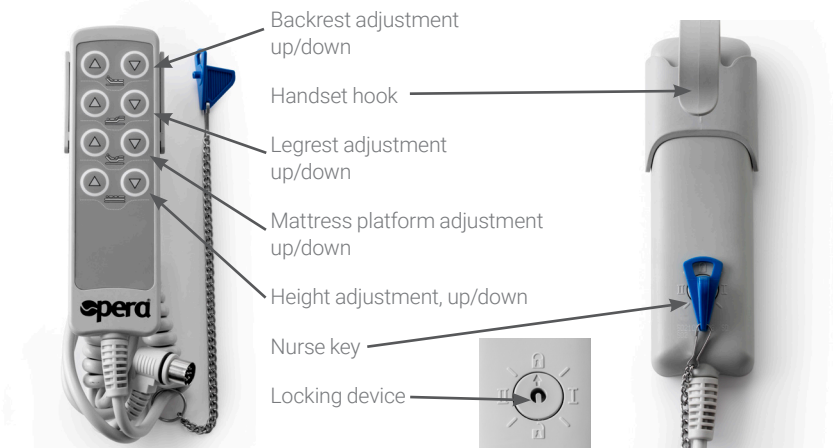

To avoid damage, the handset should always be hung up (e.g. on the mattress base or side rail) when not in use.



### ATTENTION:

Press only one button at a time, pressing multiple buttons at one time, may overload and damage the system.

## 3.3 Locking Function



Locking device



Unlocked handset



Locked handset

All electric adjustment functions can be locked by using the nurses' key.

To lock the adjusting functions insert the nurses' key into the locking device and turn the key so that the locked padlock setting is selected

The switching positions I and II are testing settings, used to check the safety of the bed during annual inspections, after repair work or each time the bed is put into storage. Please refer to page 39, section 7.2 to learn more.

### 3. Bed Operation and Maintenance

## 3.4 Operation of the Side Rails

To use the side rails, lift the upper side rail until it locks into place in the highest position.

To lower the side rails, lift the upper side rail and at the same time push the triangular release catch in the side rail runner (circled) and lower the side rails down carefully.



The side rails are designed to only prevent the occupant from falling out of the bed. Leaning or climbing on the side rail may result in injury.



When the side rails are in their highest position, ensure that they are securely locked in place, failing to do this may result in injury.

## 3.5 Operation of the Castors

All castors on the bed can be braked, to brake the castors push down on the brake peddle. The castors must always be in the braked position during normal operation.



**Brake Off**



**Brake on**



The brakes must only be released to move the bed into a new position. The bed is not intended to be used to transport occupants, doing so may result in injury.

## 3.6 Electric Emergency Lowering

The power supply unit fitted on the mattress backrest platform is equipped with a 9V block battery. This makes it possible to make a CPR emergency lowering in accordance with EN 60601-2-52 in the event of a power failure.

Please note that CPR emergency lowering is limited to one time per 9V battery and should be replaced after an emergency lowering. If the battery is not used in a two year period, it should be replaced. Replace the battery with a 9V type 6LR61 alkaline battery.

## 3.7 9V Battery Change

To replace, check or remove the 9V battery, open the battery compartment on the power supply unit, this is attached to the headrest motor.

Follow the below instructions to carry out a battery change:

- Turn off the power supply and unplug the mains plug, **failure to do this may result in electric shock and injury.**
- Take off the control box cover by removing the two screws with a cross head screw driver.
- Carefully pull out the battery holder and replace the 9V battery with a new one. Connect the new battery and slide the battery holder back in to the control box.
- Replace the cover and secure.



# 4. Troubleshooting

Fault	Possible cause	Remedy
No response	Mains plug not plugged in	Insert the mains plug into a mains socket
	Locking function on the handset has been activated	Unlock the handset (see page 24 on how to do this)
	Handset not plugged in	Insert the handset plug into the correct control box* socket (See page 10 on how to do this)
	Actuator motor/s not plugged in	Plug actuator motor/s into the correct control box* socket/s (See page 10 on how to do this)
Handset functions do not perform the correct actions	Actuator motor cables in the wrong sockets on the control box*	Ensure the colour coded plugs match the correct colour on the socket (See page 10 on how to do this)
No function after power failure	9V block battery is discharged	Replace the 9V block battery (See page 26 on how to do this)
Bed moves very slowly	Bed only adjusted via the battery	Plug in mains plug and replace the 9V block battery as a precaution (See page 26 on how to do this)

\*The control box is located underneath the mattress platform

# 5. Safety Instructions

## 5.1 General Safety Instructions



During the briefing, specific attention must be drawn to any potential dangers the first time, the Instruction Manual must be read conscientiously and in detail by the user / care personnel.

Any incidents or issues must be reported to Opera at, [support@opera-care.co.uk](mailto:support@opera-care.co.uk).



When operating the adjusting functions, there must not be any objects or limbs in the movement paths of the bed due to the risk of entrapment and crushing.

**Do not sit on the leg section of the bed when operating the raise function.**



Ensure that children cannot operate the control system and check if pets are under the bed before operating any of the functions. Never store anything under the bed.



If the physical or mental state of the patient requires, the handset can be locked on the reverse side of the handset when not in use (nurse's key). See detailed description of the locking operation at section 3.3. (it may be advisable to keep the handset out of reach of such a patient to avoid the risk of strangulation with the handset cord).

Adjustments to the bed must only be carried out by suitably instructed persons or in the presence of an instructed person.



The side rails have been designed in accordance with IEC 60601-2-52 to reduce entrapment risks and falls. When side rails are used, the following instructions must be adhered to, to ensure compliance with IEC 60601-2-52:

- Use only approved side rails supplied as an option by Opera.
- Only suitably instructed personnel are allowed to operate the side rails.
- Lower the side rails slowly and take care not to let them drop down.
- When operating the adjusting functions, the patient's limbs must not protrude beyond the mattress base or touch the side rails.
- **The side rails are only designed to prevent a person falling out of the bed; under no circumstances should they be climbed or leaned on.**

## 5. Safety Instructions

- The side rails only provide protection against rolling out of the care bed if the backrest and lower leg adjustments are in the horizontal position.
- The side rail height from the top of the mattress in uncompressed condition must be at least 220mm. If the height is less than 220mm increase the side rail height with an extension side rail kit.
- Side rails must only be adjusted to be either fully up and locked in place or fully down.
- During use, ensure that the side rails are level.
- Do not allow children to use the side rails, this may result in entrapment, injury and/or asphyxiation.
- Exercise caution when using the side rails with a disabled occupant, always conduct a risk assessment to ensure that the side rails are suitable for use.

Disconnect the mains plug from the socket before moving the bed, and take care to avoid dragging the mains plug across the floor when moving the bed.

The mains plug must always remain accessible to enable immediate cut-off by unplugging the mains plug from the wall socket in case of emergency.



The mains cable must be free and not caught up in anything, as it gets carried along when the bed height is adjusted the mains plug may be pulled out of its socket and electric leads exposed as a result.

If the mains cable or the mains plug are damaged, the relevant part must be replaced. This work should only be carried out by the manufacturer or authorised professionals.



When connecting the mains plug, do not use multiple sockets since liquids may penetrate into the sockets causing a fire hazard and a possible electric shock.



**Before cleaning and disinfection, the mains plug must be disconnected and hung up safely. Plugs for the handset and the motors which are inserted into the mattress base control box and motor unit, must remain plugged in. This is necessary to prevent water ingress into the control box.**



When the bed is stationary the castors must always be in the braked position. If the castors are not braked, the bed can move when the occupant gets in and out of the bed, since the occupant uses the bed for support. Injury can result if the care bed rolls away.

In order to move the care bed, the brake on all four castors must be released and the mattress base be adjusted to the lowest horizontal position.

The maximum duty cycle and the safe working load must not be exceeded, otherwise safe operation cannot be guaranteed (please refer to Technical Data).

Do not exceed the maximum weight limitation of the care bed. The maximum safe working load (SWL) is 205kg for the standard Signature Profiling Beds and 250kg for the Signature Profiling Bed in the 4ft bariatric version.

The bed must only be taken apart if there is no patient or occupant in it. The bed must not be used in rooms where there is a risk of explosion.

### 5.2 Safety Information for the Operator

With the help of this Instruction Manual, instruct each user in the safe operation of this care bed before it is put into service for the first time.

Advise the user of any hazards which may occur if not handled correctly.

Only persons who have been properly instructed may operate this care bed. This also applies for persons who only operate the care bed on a temporary basis.

The care bed outlined in this manual is a Class I Medical Device as defined by the Medical Device Directives 93/42 EEC. Please observe your obligations as the operator, see section 7.1.

### 5.3 Safety Information for the User

Ensure that the operator instructs you in the safe operation of this bed. In addition, pay particular attention to the safety information in section 5.1.

Adjustments of the bed must only be carried out by suitably instructed persons or in the presence of an instructed person.



Make sure that the mattress base has travelled to its lowest position before leaving the patient unattended. This will minimise the risk of injury to the patient when getting in or out of bed.

If there is a suspected fault or damage, disconnect the mains plug from the socket. Clearly mark the care bed as “Out of Order” and take it immediately out of service. Then inform the person responsible for the bed immediately.

## 5. Safety Instructions

### 5.4 Cleaning and Disinfection



Before cleaning and disinfection, the mains plug must be disconnected and hung up safely. Plugs for the handset and the motors that are plugged into the control box must remain in their sockets. This is necessary to prevent water from getting into the control system.



Do not immerse electrical components in water but wipe them with a damp cloth.

The electrical components must not be cleaned with a high pressure cleaner or a water jet. Only disinfection by wiping is permitted.



**Attention:** In the event of disinfection by large scale spraying with products containing alcohol, there is a danger of explosion and fire.

### 5.5 Servicing and Maintenance

Servicing work must only be carried out by persons who have at least read the safety regulations and are qualified according to the MPBetreibV (Operators of Medical Products Ordinance) § 4 and 6.

A technical check and/or safety inspection must be conducted at least once a year and after a lengthy break in use and before each further use. Refer to section 7.1.

Any defects, damage or signs of wear must be rectified without delay. Only original spare parts from Opera may be used, otherwise all guarantees or warranties will be excluded.

Please check all fixings on your bed at least once a month. Pay special attention to side rail components and mattress platform connections.

The 9V block battery is the energy store for electrical emergency lowering in the event of a power failure. The energy store is sufficient for one emergency lowering and must then be replaced. If the expiry date of the battery has passed it must be replaced. Since batteries are subject to self-discharging, it is recommended to use a 6LR61 alkaline manganese battery. Used batteries must be disposed of in an environmentally compatible way, contact your local waste recycling facility for further detail.



## 5.6 Accessories

The optional accessories available include a patients lifting pole, of which the safe working load is 80kg and must not be exceeded. The patients lifting pole (BOA011) may only be used within its admissible adjusting range which is defined by the sleeve on the bed. Otherwise the bed may tip up, resulting in serious injury.

The Signature Telescopic Split Side Rails (BOA082) and the standard side rails (BOA003) may be used with the Signature Profiling Beds.

Only use mattresses compatible with the side rails. The dimension between the mattress upper surface in an uncompressed condition and the top edge of the upper side rail must be 220mm minimum. If this dimension is less than 220mm, an extension side rail kit should be fitted.

## 5.7 Electromagnetic Compatibility

Regarding their emitted interference and interference resistance, the electric motor units comply with the requirements of EN 60601-1-2:2007 (see section 8.8). However it is possible that electrical devices can interfere with each other. In this case, switch off the care bed for a short time or remove the interference source.

## 5.8 Storage

If the care bed is stored for a lengthy period, the 9V block battery should be removed as it will be subject to a higher rate of self-discharge. The bed should be stored between -10°C and 60°C, in a room with a relative humidity between 30% and 75%. Keep the care bed dry and out of direct sunlight.

## 5.9 Service Life and Disposal

The normal service life for care beds in domestic use is approximately 5 years, please refer to chapter 9 for further instruction.

## 6. General Information

### 6.1 Definitions of Users

#### **Operator**

An operator is any natural or legal person who uses the care bed or on whose instruction it is used (e.g. nursing homes, specialised retailers, health insurance companies and medical product suppliers).

#### **Users**

Users are persons who as a result of their vocational training, experience or briefing are authorised to operate the care bed, carry out work on it, or are instructed in handling the bed. Furthermore, they recognise and avoid potential dangers and assess the clinical condition of the patient.

#### **Patient/Occupant**

Persons in need of care; handicapped or infirm; and occupying a care bed.

#### **Qualified Personnel**

Qualified personnel are employees of the operator, who as a result of their vocational training or briefing, are entitled to deliver, assemble, disassemble and transport the care bed. In addition, these persons are instructed in the cleaning and disinfection regulations for the care bed.

### 6.2 General Notice

Clean and disinfect the care bed before using it for the first time. Please note that the various safety instructions must be observed. Refer to chapter 5.4 on how to clean and care for the bed.

Opera Beds bear the CE mark and meet all general safety and performance requirements. The beds have been tested in accordance with international standards.

The safety and performance requirements can only be met if the user uses the care bed as outlined in this manual.

## 6.3 Intended Use

The Opera Signature Profiling Beds (including the Low footboard, Upholstered, Comfort and Bariatric) are intended for accommodating occupants in residential homes, nursing homes and the domestic environment. The care beds may only be used under the conditions for use described in this Instruction Manual.

The Opera Signature Profiling Beds (including the Low footboard, Upholstered and the Comfort beds) are designed to accommodate adults weighing up to 170kg or 26st 7lb.

The Opera Signature Bariatric Bed is designed to accommodate adults weighing up to 215kg or 33st 9lb.

The beds are intended to be used for occupants who have a condition where care from the bed is required, this may be to alleviate or compensate for handicaps and/or disabilities and to facilitate the working conditions of the carer. Any other use shall be regarded as non-compliant with the intended uses, this will void the warranty terms and conditions.

Under certain conditions the care beds may be used with other medical devices, such as antidecubitus/pressure relieving mattresses, aerators and alimentation systems. The beds may be used with the Opera Side Rails and the Signature Telescopic Split Side Rails.

The mattress must meet the technical specifications and requirements outlined in section 5 and 8. If electrical devices are used in the care bed or near the care bed, a risk assessment must be conducted and measures taken to ensure that any cables do not interfere with the bed.

### 6.4 Non-intended Use

A non-intended use is a use that deviates from the intended purpose and is not outlined in the Instruction Manual.

Non-intended uses include, but are not limited to the following:

- Loading the care bed beyond the safe admissible working load (refer to the specifications in section 8).
- Operation of the care bed by occupants who have not been instructed on its use.
- Use of the care bed for children.
- Attempting to move the care bed when in its braked position.
- Using the care bed for transporting occupants.
- Use of the care bed on a non-horizontal surface (max incline of 5°).
- Use with electrical applications which involve intravascular or intracardiac processes with the occupant.
- Use with any devices that will compromise the general safety and performance requirements of the care bed.
- Use as a hospital bed/in hospitals.

Using the care beds for any of the above uses or a use that is not outlined in this instruction manual will be regarded as non-intended, which will void the warranty terms and conditions.

### 6.5 General Regulations

The care beds must only be used for the purpose intended. When setting up, operating and using the care bed, respect the regulations in your country, the general recognised rules of technology, the occupational health and safety, and accident prevention regulations.

If the care bed is faulty, operation must not be started. Any issues or incidents must be reported to Opera Care. Please refer to the back cover for contact details.

## 6.6 Qualification of Users

The care bed must only be operated by persons who have the corresponding training or experience to enable them to handle the care bed correctly.

# 7. Servicing

Operators of care beds are obliged to conform to the servicing regulations in your country.

The test according to the regulation EN 62353 contains the following minimum requirements:

- Visual checks
- Functional tests
- Overall evaluation

A visual and functional test, including an electrical test must be carried out at least once a year. For this purpose, proceed according to the technical safety checklist as per regulation EN 62353.

**IMPORTANT:** If you have any doubts about the safety or functioning of the care bed or a component as a result of the checks performed below the bed should under no circumstances be placed into service again. Contact Opera when there is any uncertainty.

7. Servicing

## 7.1 Technical Safety Checks according to EN 62353

Care bed:.....  
 Serial No:.....  
 Location.....  
 Person responsible:.....  
 Inspected by:.....

Item	Instruction for testing	Comment	Yes	No
1.	Is the general condition OK?			
2.	Are the type plates for the bed and the motors legible?			
3.	Is the Instruction Manual available to staff?			
4.	Is the use one for which it was intended and is it safe?			
5.	No surface damage or corrosion?			
6.	Mechanical components and welded joints without faults?			
7.	Are all mechanical connecting elements securely fixed?			
8.	Mattress base underside undamaged?			
9.	Can all adjustment options for the bed be operated without hindrance on site?			
10.	Is the mechanism for locking the thigh rest in place in working order?			
11.	Are the side guard beams free of any fractures, cracks or other damage?			
12.	Do the side guard beams sit securely in their anchorage?			
13.	Has the load test been carried out successfully according to the regulations?			
14.	Are the patient's lifting pole and pole sleeve undamaged without any signs of wear?			
15.	Do the side rails lock safely into place?			
16.	Max. distance between the side rails 120mm?			

Item	Instruction for testing	Comment	Yes	No
17.	Height of side rails above the mattress at least 220mm?			
18.	Height of side guards above the mattress at least 220 mm?			
19.	Have castors including locking brake been tested for safe functioning?			
20.	Mains cable, connecting cables and plugs without damage?			
21.	Fixture available for safe transportation of mains plug?			
22.	Strain relief of the mains cable and handset securely attached?			
23.	Are all plug-in connections securely attached? (Washers without damage?)			
24.	Are cables laid correctly and safely? (No damage)			
25.	Motor housing and SMPS housing, mains plug housing without damage?			
26.	Are the thrust pipes of the height adjustment motors undamaged?			
27.	Functional test of the handset: can the buttons be operated properly?			
28.	Functional test of handset locking device: On/Off working correctly?			
29.	Testing of initial fault safety by means of integrated blocking box in handset			
30.	9V block battery OK / expiry date sufficient until next test?			
31.	Is the safe working load adhered to?			

Comments: .....

Place / Date: .....

Inspected by: .....

Next inspection: .....

Signature: .....

## 7. Servicing

### 7.2 Checking the Initial Fault Safety

To check the safety equipment, proceed as follows:

The switching positions I and II are testing settings only used to check the safety during the annual inspection, after repair work, or each time a bed is put back into service after being out of service.

- Select setting switch position 4 (padlock symbol closed). Set all bed adjustments to slightly raised positions.
- Select setting switch position 3 (padlock symbol closed). When operating the adjustment buttons, no motorised adjustments should be possible.
- Select the switch on the back of the handset to testing position 1 (symbol I). When operating the adjustment buttons no motorised adjustments should be possible.
- Select the switch on the back of the handset to position 2 (symbol II) When operating the adjustment buttons, no motorised adjustments should be possible.

## 8. Technical Specifications

### 8.1 Technical Data

Specification	3ft	3ft 6"	4ft	Bariatric 4ft
Max. weight of occupant	170kg/26st 8lb			215kg/33st 9lb
Height range (floor to top of mattress platform)	255-730mm/10.0"-28.7"			
External length	2079mm/81.8"			
External width	1041mm/40.9"	1191mm/46.9"	1341mm/52.8"	
External height (in lowest position)	782mm/30.8"			
External height (in highest position)	1305mm/51.4"			



## 8. Technical Specifications

Specification cont.	3ft	3ft 6"	4ft	Bariatric 4ft
Internal length	2000mm/78.7"			
Internal width	900mm/35.4"	1050mm/41.3"	1200mm/47.2	
Upper level of head section/foot section	70°, 30°			
Height adjustment of mattress base (range) from	255-778mm/10.0"-30.6"			
Backrest adjustment adjustable electronically up to	approx. 70° (electric, stepless)			
Thigh rest adjustment adjustable electronically up to	approx. 30° (electric, stepless)			
Foot rest in raised position (Raised mechanically) to	-25° to -0° degrees in five stages			
Mattress base surface	Powder-coated steel			
Wooden side guards (with plastic ends)	1973 x 115 x 28mm (77.8" x 4.5" x 1.1")			
Castors with individual lockable brake	4 of 4			
Max. castor loading capacity	90kg/pcs			
Operating noise	< 53 db(A) at a distance of 1m			
Maximum mattress depth	165mm/6.5"			
Recommended mattress length	2000mm/78.7"			
Recommended mattress width	900mm/35.4"	1000mm/39.4"	1200mm/47.2"	
Backrest length	743mm/29.2"			
Thighrest length	350mm/13.8"			
Legrest length	540mm/21.3"			

## 8. Technical Specifications

Specification cont.	3ft	3ft 6"	4ft	Bariatric 4ft
Maximum backrest angle	approx. 70°			
Maximum legrest angle	approx. 30°			
Safe working load -SWL ( Max weight of patient + Mattress + Accessories)	Max. weight of patient: 170kg/26st 8lb Advisory weight of mattress: 20kg/3st 1lb Advisory weight of accessories: 15kg/2st 4lb SWL: 205kg/32st 3lb			215kg/33st 9lb 20kg/3st 1lb 15kg/2st 4lb SWL: 250kg/39st 4lb
<b>Side Rails</b>				
Weight	Approx 2.8kg per rail			
Height in lowest and highest position	100mm-431mm/3.9"-16.9"			

### 8.2 Technical Data (Electrical)

Power supply unit	SMPS
Voltage rating	Input voltage: 100-240V AC and Output voltage: 29V DC
Frequency rating	50-60Hz
Type of current	Input voltage: AC and Output voltage: DC
Nominal consumption during operation	approx. 70 W
Nominal consumption in idle state	approx. 0.5W
Nominal operating time	max. 2 minutes (max. 5 switch cycles/minutes)
Nominal idle time	18 minutes
Primary safety fuse	2A
Battery for emergency lowering	x 1 6LR61
Mattress base motor units (back/leg)	MD100 (limoss)
Height adjustment motor unit	MD102 (limoss)
Motor unit protection class	III

### 8.3 Classification

Medical Device Class (MDD 93/42 EEC)	Class I
Degree of protection to DIN EN 60601-2	Group 1, Class B (CISPR11)

Housing degree of protection to EN 60529	Power supply unit: IP66 motor Motor units: IP44 Control box: IPX6 Hand switch: IP44
Max. duty rating	max. 2 minutes
Max. switching cycles/mins	max. 5 switch cycles/minutes
Safety inspections	Annually

## 8.4 Technical Data (Environmental)

Temperature range during operation	+10°C to + 40°C
Temperature range for storage/transport	-10°C bis to 60°C
Humidity of the air for storage/transportation	30% to 75% rel.
Air pressure for storage/transportation	700 to 1060 hPa

## 8.5 Weights of the Individual Components

Mattress platform - head section	24kg
Mattress platform - leg section	20.5kg
Bed chassis	45kg
Head and foot board (individual)	10kg
Wooden side rails	Approx 2.8kg each
Transportation bracket	10kg

## 8.6 Information about Electromagnetic Emissions

Guidance and Manufacturer's Declaration - Electromagnetic Emissions		
The care bed is intended for use in the electromagnetic environment specified below. The customer or user of the care bed should ensure that it is used in such an environment		
Emitted interference	Compliance	Electromagnetic Environment - Guidelines
RF emissions according to CISPR11	Group 1	The care bed uses RF energy only for its internal functioning. Therefore the RF emissions are very low and it is unlikely that nearby electronic devices will be disturbed

## 8. Technical Specifications

RF emissions according to CISPR11	Class B	The care bed is designed for use in all establishments including domestic establishments and those determined to be directly connected to a public supply network that supplies buildings used for residential purposes
Emissions of harmonics according to IEC 61000-3-2	Class A	
Emissions of voltage fluctuations/Flicker according to IEC 61000-3-3	Complies	

### 8.7 Information about Electromagnetic Interference Immunity

Guidance and Manufacturer's Declarations - Electromagnetic Interference Immunity			
The care bed is intended for use in the electromagnetic environment specified below. The customer or user of the care bed should ensure that it is used in such an environment			
Interference Immunity Certification	IEC 60601 Test Level	Compliance Level	Electromagnetic Environment - Guidelines
Electrostatic Discharge (ESD) according to IEC 61000-4-2	± 6 kV Contact discharge	± 6 kV Contact discharge	Floors should be wood, concrete or ceramic tile floors
	± 8 kV Air discharge	± 8 kV Air discharge	If the floor is covered with synthetic material, the relative humidity should be at least 30%
Electrical fast transients/ bursts according to IEC 61000-4-4	± 2 kV For power lines ± 1 kV for input and output lines	± 2 kV For power lines ± 1 kV For input and output lines	The quality of the supply voltage should be equivalent to that of a typical business or hospital environment

## 8. Technical Specifications

<p>Surges according to IEC 61000-4-5</p>	<p>± 1 Kv Voltage phase-phase conductor</p> <p>1 Kv Voltage phase-ground conductor</p>	<p>± 1 Kv Voltage phase-phase conductor</p> <p>1 Kv Voltage phase-ground conductor</p>	<p>The quality of the supply voltage should be equivalent to that of a typical business or hospital environment</p>
<p>Voltage dips, short interruptions and supply voltage variations according to IEC 61000-4-11</p>	<p>&lt; 5% UT for 1/2 cycle (&gt;95% dip)</p> <p>40% UT for 5 cycles (60% dip)</p> <p>70% UT for 25 cycles (30% dip)</p> <p>&lt;5% UT for 5s (&gt;95% dip)</p>	<p>&lt;5% UT for 1/2 cycle, 10ms (&gt;95% dip)</p> <p>40% UT for 5 cycles 100ms (60% dip)</p> <p>70% UT for 25 cycles 500ms (30% dip)</p> <p>&lt;5% UT for 5s (&gt;95% dip)</p>	<p>The quality of the supply voltage should be equivalent to that of a typical business or hospital environment. If the user of the care bed also requires continued operation during interruptions in energy supply demands, it is recommended to feed the care bed from an uninterruptible power supply or a battery</p>
<p>Magnetic field of power frequency (50/60Hz) according to IEC 61000-4-8</p>	<p>3 A/m</p>	<p>0.3 A/m</p>	<p>Magnetic fields of power supply frequency should comply with the typical values, as can be found in a business and hospital environment</p>

## 8.8 Information about Non Life Support Devices

Guidance and Manufacturer's Declarations - Non-Life-Support-Devices Electromagnetic Interference Immunity			
The care bed is intended for use in the electromagnetic environment specified below. The customer or user of the care bed should ensure that it is used in such an environment			
Interference Immunity Certification	IEC 60601 Test Level	Compliance Level	Electromagnetic Environment Guidelines
<p>Conducted RF interferences according to IEC 61000-4-6</p> <p>Emitted RF interferences according to IEC 61000-4-3</p>	<p>3 V eff 150 kHz-80 MHz</p> <p>3 V/m 80 MHz-2.5 GHz</p>	<p>3 V eff 3 V/m</p>	<p>Portable and mobile radios, including cables, should not be used closer to the care bed than the recommended working clearance that is calculated by the equation for the appropriate frequency</p> <p>Where P is the Power of the transmitter in Watts (W) according to specifications of the transmitter manufacturer and D is the recommended working clearance in meters</p> <p>Field strengths from fixed RF transmitters should, at all frequencies, according to a site survey, a-Note p.5 be lower than the level of agreement be b- Note.p.5.</p> <p>In the vicinity of equipment, bearing the following symbol, interference</p>
<p>Note 1: At 80 and 800 MHz, the higher frequency range must be taken</p> <p>Note 2: These guidelines may not apply in all situations. The propagation of electromagnetic waves is affected by absorption and reflection from structures, objects and persons</p> <p>a) Field strengths from fixed transmitters, such as base stations of mobile telephones and land mobile radios, amateur radio, AM, FM radio and TV broadcast can not be predicted theoretically with accuracy. To assess the electromagnetic environment due to fixed RF transmitters, an electromagnetic site survey is recommended. If the field strength at the location of the care bed exceeds the specified compliance level above then the care bed should be monitored with respect to its normal operation. If abnormal performance is observed, it may be necessary to take additional measures, such as reorienting or relocating the care bed</p> <p>b) Over the frequency range 150 kHz to 80 MHz, field strengths should be less than 3 V/m</p>			

## 8.9 Working Clearances between Communicators

Recommended working clearances between portable and mobile RF communications equipment and the care bed			
The care bed is intended for use in the electromagnetic environment in which radiated RF disturbances are controlled. The customer or user of the care bed can help to prevent electromagnetic interference by maintaining a minimum distance between portable and mobile RF communications equipment (transmitters) and the care bed as recommended below, according to the maximum output power of the communication device.			
Output Power of Transmitter in Watts (W)	Working clearance according to transmission frequency (In meters - M)		
	150 kHz to 80 MHz at 3 V/m	80 MHz to 800 MHz at 3 V/m	800 MHz to 2.5 GHz at 3 V/m
0.01	0.12	0.12	0.23
0.1	0.38	0.38	0.73
1	1.2	1.2	2.3
10	3.8	3.8	7.3
100	12	12	23
For transmitters not rated in the list above, the working clearance can be determined using the equation, which belongs to the transmitter, where P is the nominal output of the transmitter in Watts (W) according to specifications of the transmitter manufacturer.			
Note 1: An additional factor of 10/3 is applied when calculating the recommended working clearance between transmitters in the 80 MHz to 2.5 GHz frequency range in order to reduce the probability that a mobile/portable communications device unintentionally brought into the patient area could lead to interference.			
Note 2: These guidelines may not apply in all situations. Propagation of electromagnetic waves is affected by absorption and reflection from structures, objects and persons.			

## 9. Service Life and Disposal



The service life of the care beds is approximately 5 years. This is dependent upon the manner of use. The care bed is suitable to be put into service again if all measures of section 2 and 7 are taken. Frequent transportation, setting up and adjustment, reduce the service life, as does improper treatment, irregular servicing and exceeding the safe working load or the admissible load cycle of the electric motors. The care bed must not be disposed of as normal household waste after the end of its service life. Contact your local waste recycling facility for further information.

## 10. Guarantee

As stated in the Warranty Terms and Conditions, below, Opera provides a manufacturer's warranty of 3 years from the date of purchase.

## 11. Opera Warranty Terms and Conditions

### 11.1 Warranty Terms

11.1.1 Subject to the terms and conditions set out below, Opera agrees to repair or replace the product within the United Kingdom at its own cost, and any Opera accessory supplied with it, purchased by you from Opera. In circumstances where the product does not perform in accordance with Opera's specifications during the warranty period of 3 years, commencing on the date of delivery (or deemed delivery) of the product.

11.1.2 This contractual product warranty does not operate to limit rights under the statutory warranties referred to in clause 11.3.1 below.

### 11.2 Warranty Conditions

11.2.1 Proof of purchase (invoice) must be provided when requesting service under warranty.

11.2.2 Opera requires any customer requesting service under the warranty to comply with directions from Opera staff in relation to troubleshooting any issue and facilitating any repair or replacement under these Warranty Terms and Conditions.



**11.2.3** The customer is responsible for inspecting all goods received from Opera upon arrival. In instances where goods have been damaged in transit, the customer must report this to Opera within 3 working days of receipt of the product. Failure to report physical damage on arrival within three working days of receipt may result in denial of warranty for physical damage.

**11.2.4** Opera reserves the right to replace the product or relevant part with the same or equivalent product or part, rather than repair it. Where a replacement is provided, Opera will determine, in its discretion, the closest product within the current range of products offered by Opera with which to replace the faulty or damaged product. The replacement product may differ with the replaced product in size and specifications, at the reasonable election of Opera. Opera may replace parts with refurbished parts. Replacement of the product or a part under the warranty does not extend or restart the warranty period.

**11.2.5** If Opera is unable to repair or replace the product, the customer will be provided with credit for Opera products or may be refunded the price of the product (at Operas election). This credit or refund will be for the amount of the purchase price of the product, excluding the associated delivery cost.

**11.2.6** In the event that a replacement, refund, or store credit is provided as per section 11.2.5, the faulty item will become the property of Opera.

**11.2.7** Opera may seek reimbursement of any costs incurred by you where the product is found to be in good working order.

**11.2.8** Opera reserves reasonable discretion to determine whether any product is or is not performing in accordance with Opera specifications, subject to applicable law.

### 11.3 General

**11.3.1** Legislation may imply warranties or conditions or imposes obligations on Opera, which cannot be excluded, restricted or modified in relation to consumer goods.

**11.3.2** To the full extent permitted by law, but subject always to clause 11.3.1, the warranty will not apply in respect of a product:

- (a)** If the product has not been installed, operated, maintained or used in accordance with the Opera instructions or specifications provided with the product;
- (b)** If the factory-applied serial number has been altered or removed from the product;
- (c)** To damage, malfunction or failure resulting from alterations, accident, misuse, abuse, fire, liquid spillage, mis-adjustment of customer controls, use on an incorrect voltage, power surges and dips, thunderstorm activity, force majeure, voltage supply problems, tampering or unauthorised repairs by any persons, use of defective or incompatible accessories, exposure to abnormally corrosive conditions or entry by any insect, vermin or foreign object in the product.
- (d)** To damage arising during transportation, installation or while moving the product or to any transportation costs of the product or any parts thereof to and from the customer, unless otherwise specified in these warranty terms and conditions;
- (e)** To any third-party software or hardware not contained in the product as originally configured by Opera.
- (f)** To any failure, to the extent that the failure is not a failure of the product to perform in accordance with its specifications.
- (g)** To service of any product whilst it is outside the United Kingdom.

**11.3.3** To the full extent permitted by law, but subject always to clause **11.3.1**:

**(a)** Opera will not be liable for any loss, damage or alterations to third party products, no matter how occurring; or for any loss or damage arising from loss of use, loss of profits or revenue, or for any resulting indirect or consequential loss of damage.

**(b)** Opera's aggregate liability in respect of all claims under the warranty shall not exceed the original purchase price of the product or, at Opera's option, the replacement of the product with a like or similar product.

**(c)** Opera excludes all other warranties, conditions, terms, representations and undertakings whether express or implied.



## **Opera Care**

Azure House, Connaught Road,  
Kingswood, Hull. HU7 3AP

0333 222 8584

[support@opera-care.co.uk](mailto:support@opera-care.co.uk)

[opera-care.co.uk](https://opera-care.co.uk)

Version 2 | Published September 2020