

Instruction Manual Ver 1.00

FES-255

Connection Tarp Hexa Pro. Air



Thank you for purchasing this Snow Peak Product. This product is a tarp designed for camping. For safety, read the following instruction manual before use. Please keep it safe for future reference. Finally, if you find anything that you do not understand in the description or any problems with the product, please stop use immediately and contact the retailer or Snow Peak Customer Service.

Contents

The contents are designed to be set up in normal conditions. This product is a tarp that connects to the specified shelter. Basic setup requires one 280 cm / 9'2" wing pole, the tarp, and the pegs used to secure the tarp. These items are required separately. Pegs, ropes, and rope tensioners are consumables. We recommend that you always carry spares of these items.

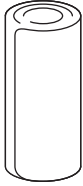

Tarp x 1



Carry bag x 1

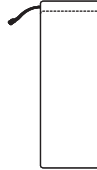

Pole case x 1



Peg case x 1

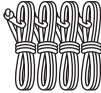

Ropes with rope tensioners
10 m / 32'8" forked end x 1, 4 m / 13'1"
x 2, 3 m / 9'8" x 2

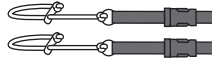

Pole mounting rope
with rope tensioner x 2



Instruction manual
(this document) x 1

Name of the Parts

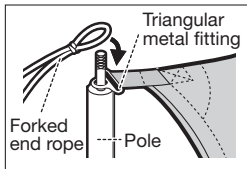

* The actual tarp color is ivory, however, the tarp is colored in the instruction manual so that it can be easily identified.

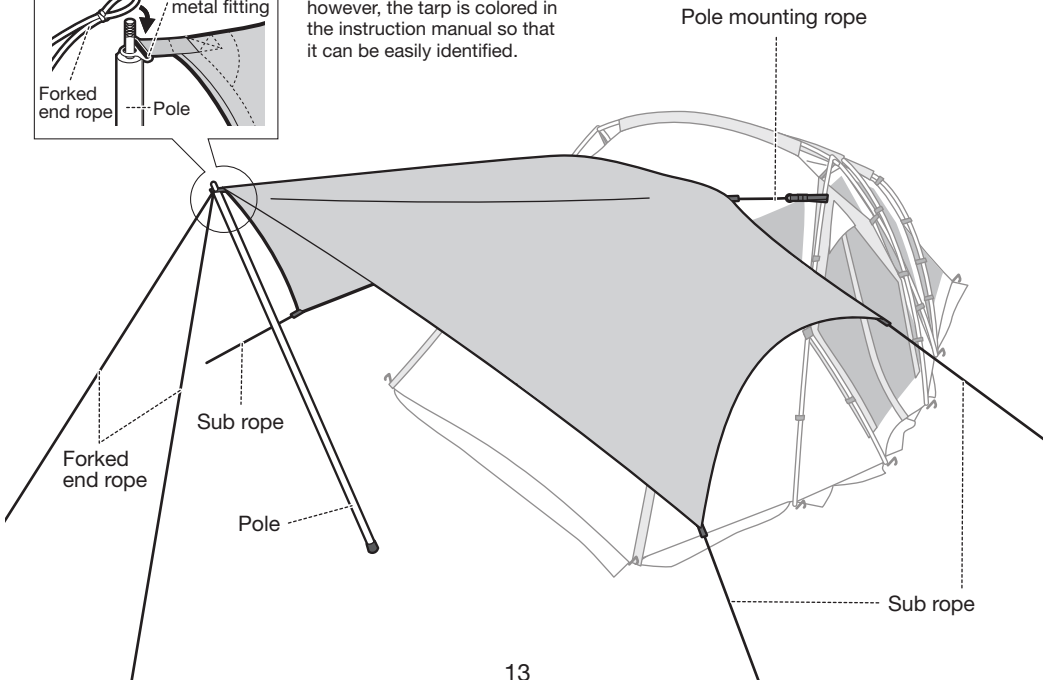

⚠ DANGER: Misuse could easily result in a serious accident or death.

- The material of this tarp is not flameproof. Do not use combustion-based heat sources such as lanterns, stoves, or heaters, or open flames or fire such as matches, candles, lighters, or cigarettes, under the tarp. The use of such heat or light sources inside a small enclosed space is hazardous and may result in fire.
- Do not keep fuel or flammable items for replenishing the fuel under the tarp.



⚠ WARNING: Misuse could result in serious injury or death.

- Pay close attention to the weather. If extreme weather is in the forecast, pack up camp and evacuate to a safe place.
- Choose a flat, well-drained area with firm ground to pitch the tent. Choose a place with no chance of avalanches, landslides, wind gusts, or sudden flooding.



⚠ CAUTION: Misuse could result in injury to the user and/or damage to property.

- It is not recommended that this product, Connect Tarp Hexa, be used together with shield roofs for the following reasons:
 - If a shield roof and Connect Tarp Hexa are used together, they will rub against each other, which may reduce the water-repellent characteristic of the fabric.
 - The pole mounting rope and the shield roof intersect, which may damage the shield roof.
- Sunlight can cause the surface of the tarp to heat up, potentially causing low-temperature burns.
- Do not assemble or use this product close to a fire, fireworks, etc. Flying sparks can create holes in the fabric.
- When assembling or disassembling the tarp, firmly support the pole so that the tarp will not be blown by the wind, and secure it using pegs or rocks. Be sure to confirm the safety of your surroundings, such as whether there are any people nearby. Otherwise, an unexpected accident may occur, for example, when the edge of the pole rebounds as the pole falls over.
- Secure the tarp using a tension rope.
- This product is made of a thin fabric, so it may break if you pull the fabric excessively.
- If this product is left in the sun for long periods of time, the tarp materials may fade, or the fabric may deteriorate and lose its strength. Do not leave the product set up permanently.

Before using this product for the first time

- Please check that all accessory items are included before attempting to assemble the product. Practice assembling and handling the product in a safe location before using it while camping. In the unlikely event that there is a problem or a missing accessory, please contact the dealer where you purchased the product, or Snow Peak Customer Service.
- This product does not include wing pole, pegs, hammers, etc. that are required for the setup process.
 - Basic setup requires one 280 cm / 9'2" wing pole, the tarp, and six pegs used to secure the tarp. These items are required separately. Please prepare them after referring to the recommended size below.
 - Recommended pole and peg sizes
 - 280 cm / 9'2" wing pole x 1
 - Peg with a driving length of 25 cm / 9.8" or more x 6

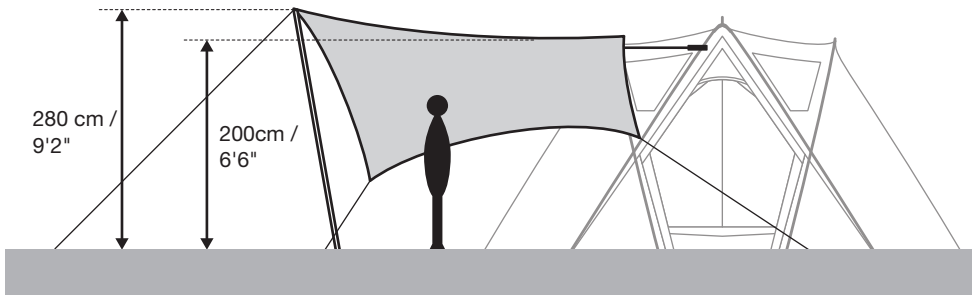

Adjustment of pole mounting rope length

The pole mounting rope has an extra length so that it can be connected to various shelters. Because the required rope length differs depending on the model, cut off the excessive length of rope. (Refer to the following.)

If the rope position overlaps with the position of the shelter sleeve when you attach the rope to the specified pole, pass it over the sleeve.

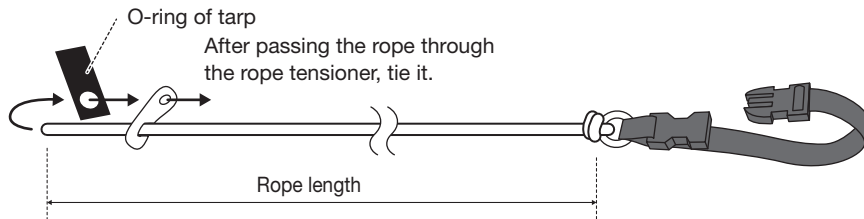

Shelter used / Mounting direction	Mounting Pole	Rope length
Land Lock	Pole A (tarp side)	Approx. 20 cm / 7.9"
Living Shell	Pole A (tarp side)	Approx. 90 cm / 35.4"
Living Shell Long / doorway side	Pole A (tarp side)	Approx. 90 cm / 35.4"
Living Shell Long / rear side (tent connection side)	Pole A (tarp side)	Approx. 170 cm / 5'6"

Rope with rope tensioner, peg down position

Secure and peg down the tension ropes as shown below.

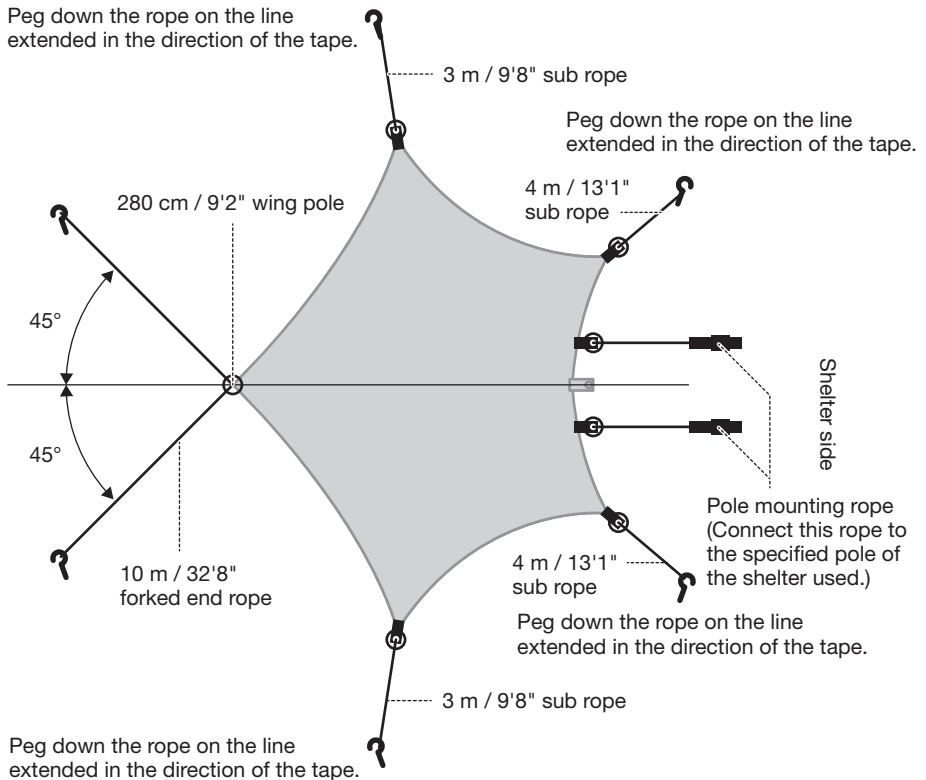

Please note that if you peg down a rope at a position where the angle between the ropes at the main corner is 90° or more, appropriate tension will not be transmitted to the poles, which will prevent you from setting up the tarp correctly. The ideal position to insert the peg is the place where the rope is at an angle of 45° to the ground when set up. [Fig. A] Insert the pegs at a 90° angle to the rope. [Fig. B]

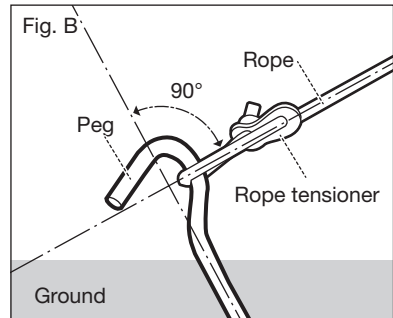
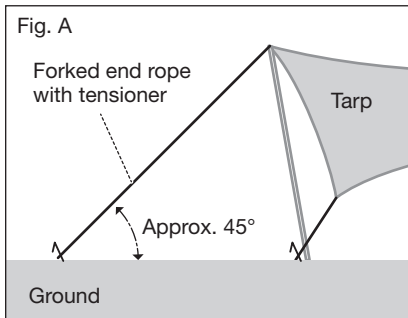

Setup procedure Please be sure to have two or more people available to set up the tarp.

Please practice tent setup and disassembly repeatedly according to the following explanation to prepare for use when camping. Make sure that you have all the accessories in advance. Inappropriate setup or disassembly may damage this product or wing poles, or lead to an accident. Please read this manual carefully before use.

- ① Spread the tarp.
Spread the tarp on a flat surface. At this time, make sure that all the peg down positions of the shelter to be connected are correctly secured. Please note that if the shelter is not secured correctly, the tension will not be transmitted, which may prevent you from setting up the tarp correctly.

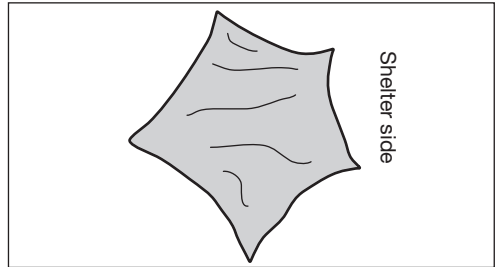

- ② Connect two pole mounting ropes to the shelter.
Attach one pole mounting rope to the specified pole of each shelter. At this time, adjust the position of the rope tensioner so that it comes to approximately halfway between the ends of the rope as shown in the figure. While covering the shelter with the tarp, attach the pole mounting rope on the side opposite the specified pole in the same way.
* For details on the specified pole, refer to the table shown on page 3.

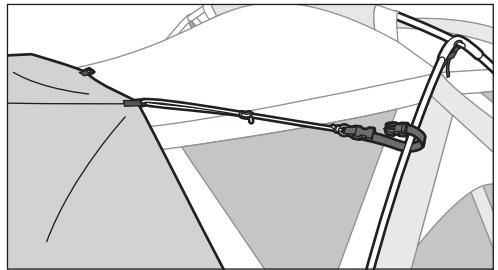

- ③ Attach the pole to the forked end rope.
After checking that the center line of the tarp and the center line of the shelter are on the same line, insert the end of the pole into the triangular metal fitting at the main corner, and hang the forked end rope from above. At this time, adjust the rope tensioner positions to ensure that all the rope ends are the same length.

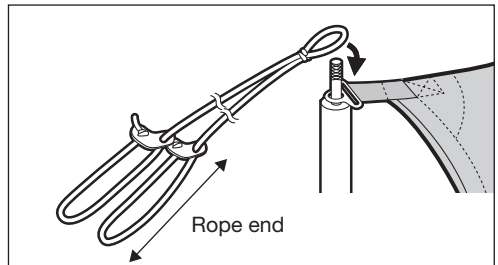

- ④ Raise the pole and peg down the forked end rope.
Raise the pole and peg down the rope according to "Rope with rope tensioner, peg down position" on page 4.

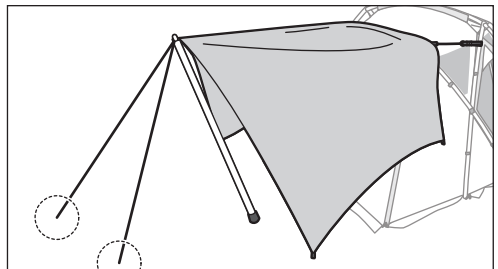

- 5 Slacken the ridgeline part. Adjust the tensioner position of the rope so that the ridgeline part is slackened by approximately 20%. This slackness creates a beautiful curve when setup is completed.

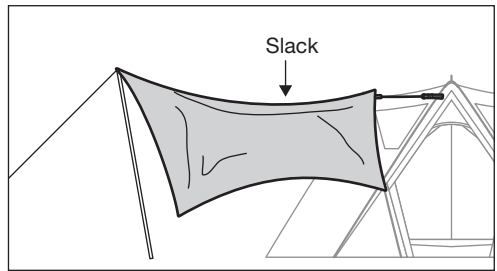

- 6 Peg down the sub ropes. Peg down according to "Rope with rope tensioner, peg down position" on page 4.

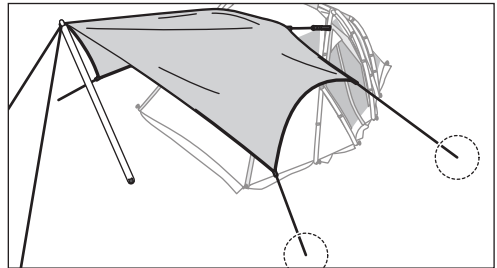

- 7 Apply tension to each rope. First apply tension to the sub ropes in numerical order. Pull the sub ropes on both wings evenly by applying approximately 80% of your strength. When you finish pulling a sub rope, then pull the rope in its diagonal position. After the slackness of the ridgeline is completely removed, apply tension to the main forked end rope. Finally, apply tension to all the ropes again in numerical order to finish.

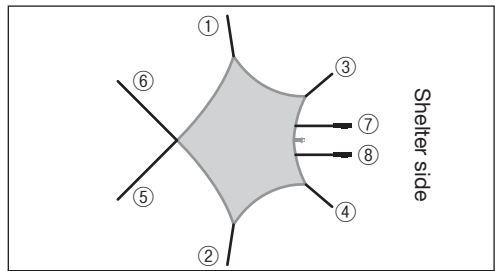

* Be careful not to apply too much tension. If you pull the rope excessively, you will see large wrinkles in that direction. Loosen the sub rope attached to corners that are wrinkled to adjust the overall tension balance. If you use the tarp when it is loose or wrinkled, risks may occur. For example, the tarp may fall over due to a strong wind, or rain may accumulate on it.

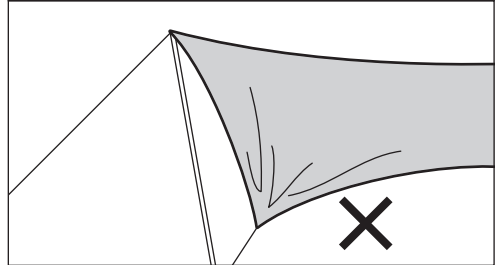

- 8 The tarp has been set up. Finally, look at the entire setup and adjust tension(s) if necessary.

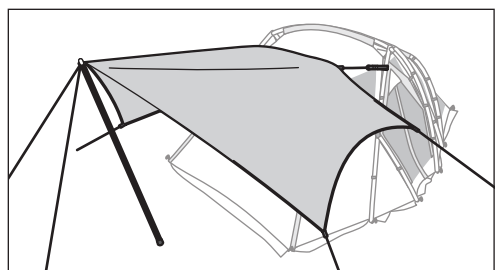

When setting up the tarp independently

You can also set up the tarp independently without connecting it to the shelter. In that case, you will need one more pole, one more set of 10 m / 32'8" forked end ropes, and two more pegs. The positions of the tension ropes (rope with rope tensioner) and peg down positions are as follows:

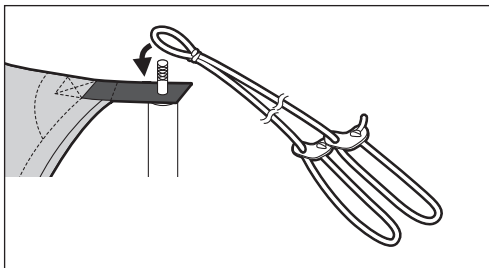
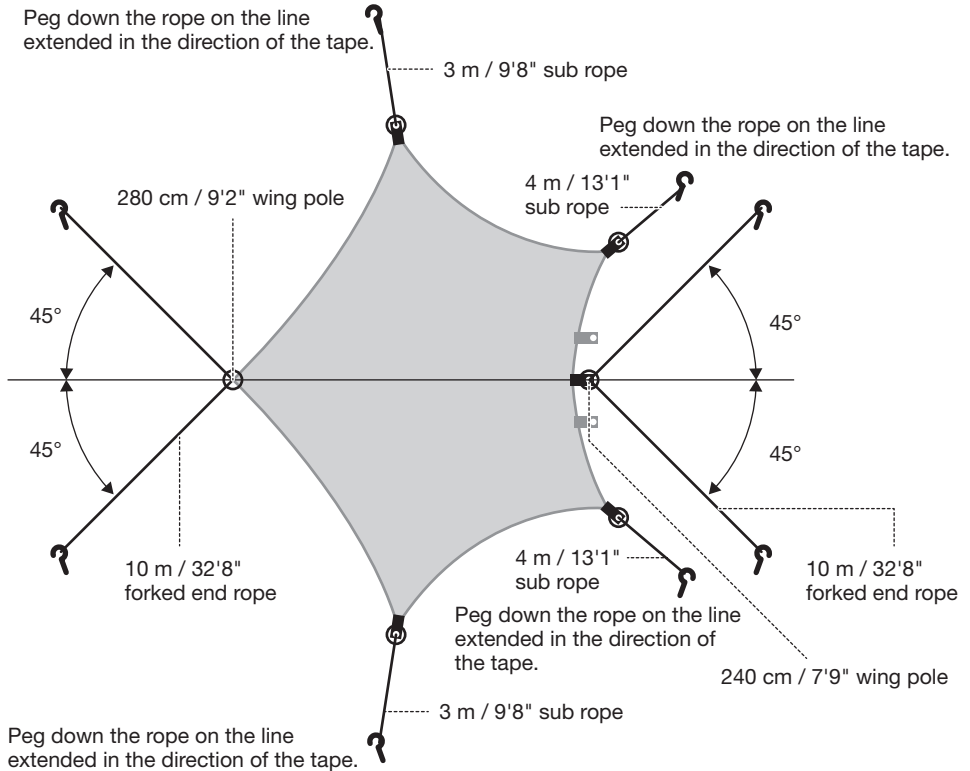

Insert the pole into the grommet on the center line on the shelter side of the tarp, and hang a forked end rope to set it up. The basic part of the setup method is the same as that used when connecting the tarp to the shelter.

Disassembly procedure This product should always be assembled/disassembled by two or more people.

Make sure there is nothing under the tarp before you start disassembling the tarp. Be sure to remove items used under the tarp to outside the tarp, and keep a sufficient distance from the tarp.

- 1 To disassemble, basically perform the setup procedure in reverse order.

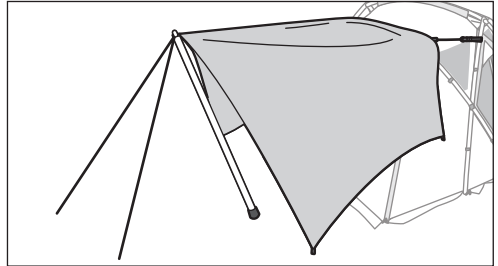

- 2 Fold the tarp in half so that the back side comes inside.

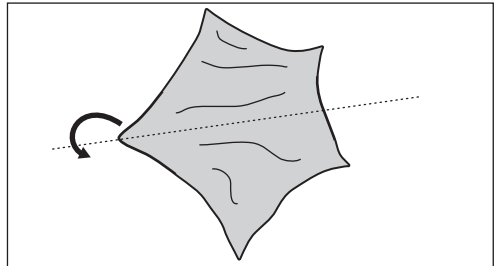

- 3 Fold the tarp to match the width of the carry bag.

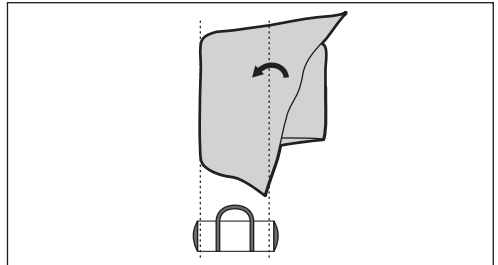

- 4 Roll the tarp up while removing air, and store it in a carry bag.

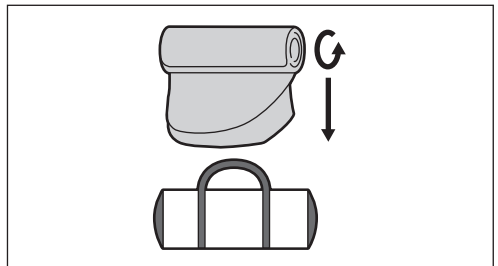

Precautions for disassembly and storage

- Make sure that the product is sufficiently dry before storing it.
- If the wind is strong, wait for it to subside before disassembling the tent.
- Remove all pegs, clean them, and store them in the peg case with their heads facing down. Store all wing poles in the wing pole storage case. If they are exposed, they may damage the fabric or the carry bag.

Water-repellent and waterproof functions

- The fabrics of this product are treated with a high-quality, water-repellent finish. However, the level of the water-repellent ability and durability may vary slightly due to the characteristics of each material. The water-repellent finish will lose its effectiveness after repeated use. When the water-repellent ability decreases, please use a water-repellent spray purchased from your local outdoor gear retailer. When using such sprays, please follow the product's instructions.
- Although this product is made of highly waterproof fabric, rainwater may soak into it if it is in contact with water pools on the ground for long periods of time.
- The PU coating may be damaged by agricultural chemicals, which cause the water pressure resistance to decrease to an abnormal degree. Please note that the product will not be covered by the warranty if it is damaged by agricultural chemicals.
- The logo may peel off due to the effect of the water repellent agent.

The effect of ultraviolet rays

- If this product is left in the sun for long periods of time, its materials may fade, or the fabric may deteriorate and lose its strength. Do not leave the product set up permanently.

Maintenance & storage

- A polyester fabric blend is used for this product. Considering the material characteristics, we adopted processing and color patterns that will result in less color migration. However, depending on storage conditions, slight color migration may occur. Do not store the product while it is wet.
- Note that this product is made of a material that wrinkles easily.
- Before storing, the product should be cleaned and dried. If the product is stored while wet, the build-up of mold, bad odors, color migration, and material deterioration will occur. Dry the product sufficiently in a breezy and shaded area and clean the surface using a soft brush before storing.
- Clean and dry the surface of the poles before storing. If stored when wet, corrosion may occur, resulting in strength deterioration. Keep the joints clean and apply a small amount of silicone lubricant. Applying an excessive amount of lubricant will stain the fabric.
- Please store in a well-ventilated area away from direct sunlight, high temperatures, and humidity.
- Small areas of fabric damage can be fixed with repair tape. Please read the repair tape manual carefully before applying.
- Depending on the conditions during use, the tent material may deteriorate over a wide area, losing its durability and becoming irreparable.
- In preparation for the next use, regularly check and maintain the product, including accessories such as tension ropes.
- Seam tape is pressure-capped at a temperature setting that prevents the PU coating from being damaged. However, it may peel off as it is used repeatedly. If peeling is discovered, set an iron at a low temperature and reattach the peeling sections only. Be aware that excessive heat will discolor or accelerate the deterioration of the fabric. Do not forcibly peel off the seam tape. If the PU coating peels off completely, it may not be possible to repair.
- Sap cannot be easily removed. Do not set up this product under trees that frequently drop sap. If the sap is forcibly removed with a solvent, etc., the fabric or coating may be damaged.

Warranty

Snow Peak has taken all possible measures to ensure every product is durable and functions correctly. If you find any product defects, please contact the retailer where you purchased the product, Snow Peak, or the contact information provided for each product. If apparent defects in the product's manufacturing are found, the defective product will be repaired or exchanged free of charge. In other cases, Snow Peak will repair the product for an appropriate fee. The decision to repair or replace the product will be at our discretion. Snow Peak will not be able to repair the product or any damage that occurred due to any of the following:

1. Material deterioration caused by age
2. Damage caused by modifications or rough handling
3. Damage caused by inappropriate use not mentioned in the instruction manual
4. Damage caused by unexpected accidents
5. Any damage other than defects in the manufacturing process
6. Damage caused by dust or rust
7. Damage and defects caused by dismantling the product
8. Damage and defects caused by dropping, jolting or other shocks
9. Deterioration or failure of parts due to friction
10. Damage caused by the use of the product in combination with another manufacturer's products

Repair

- If professional repair is necessary, please contact the dealer where you purchased the product or Snow Peak Customer Service.
- Please dry and clean the product before sending it for repair.
- Please attach a memo onto the damaged area of the product. In the memo, include details explaining the circumstances that led to the damage.
- Transportation and repair costs are determined as follows.
 1. If the damage is subject to warranty, Snow Peak will cover the transportation cost (both ways) and repair cost.
 2. If the damage is not subject to warranty, the customer will cover the transportation cost (both ways) and repair cost.

Specifications

- Contents:Tarp, Ropes with rope tensioners (Forked end 10 m / 32.8' x 1, 4 m / 13.1' x 2, 3 m / 9.8' x 2), Pole mounting rope with rope tensioner (x2), Carry bag, Pole case, Peg case
- Material(s):Tarp / 75D silicon polyester ripstop, Shield pigment PU coating waterproof rating: 1,500mm minimum
- Carry bag size:80 × 17 × 23(h) / 31.5" x 6.7" x 9.1"
- Weight:2.0 kg / 4.4 lbs

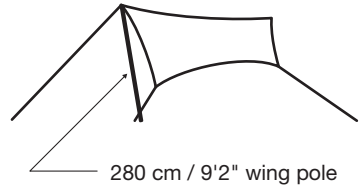
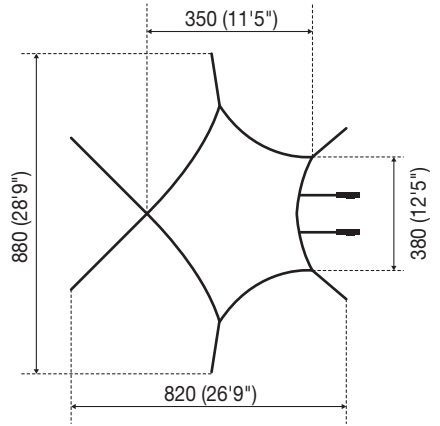

If you have any questions or concerns, please contact your retailer or Snow Peak customer service.

Snow Peak Customer Service

+1(503)461-0781 (9:00-17:00)
Email: info@snowpeak.com

Snow Peak USA, Inc.

404 NW 23rd Avenue, Portland, Oregon 97210, USA
Tel. +1 (503) 461-0781 / Instagram. @snowpeakusa
Email. info@snowpeak.com / www.snowpeak.com

MADE IN CHINA