

LUPINE

LIGHTING SYSTEMS



LIGHTBOOK 2021 / 2022
INTERNATIONAL

TABLE OF CONTENT

ABOUT US	4 - 13
BIKE LIGHTS	14 - 37
E-BIKE LIGHTS	38 - 57
HEADLAMPS & HELMETLIGHTS	58 - 93
FLASHLIGHTS	94 - 109

OUR PHILOSOPHY

We were one of the first to develop shockproof and waterproof lamps for outdoor use based exclusively on LED technology. It is this advanced experience and our unique will to create the perfect light for your activity that makes us what we are.

We are helped in this by our employees' many years of experience and, above all, by the experience of our customers and athletes. Mountain bikers, winter sports enthusiasts, climbers and mountaineers: But our products aren't just used by all kinds of athletes – they're also used by well-known institutions such as mountain rescue services, various special forces, the police, the military, the fire brigade, government agencies/authorities, research expeditions and all kinds of industrial customers. It is their needs and requirements that drive us forward.





DESIGN & DEVELOPMENT

Yes, our lamps are damn bright, but we don't build some sort of "lumen monsters". Outdoor lights from Lupine impress thanks to their numerous lighting options, ease of use and impeccable workmanship with minimal weight and size. High-quality aluminium housings make our lamps elegant, robust and waterproof. In conjunction with the sophisticated electronics, they also play a key role in heat regulation and thus in the efficiency of our lamps.

The interplay of LED and lens forms another core element: the highly-efficient thin-film LEDs we use emit light in a large, uncontrolled area. Only by using our specially developed lenses can we use one hundred percent of the light where it is needed. In order to optimally illuminate the far and near range, several individual lenses are arranged to form a perfectly coordinated system. In this way we create lighting patterns that are perfectly suited for their task as both a bike lamp and outdoor lighting.

MADE IN GERMANY

More than 25 years of quality – Made in Germany. We develop and manufacture our products exclusively in Germany. We do without automation and machines for the most part, preferring instead to trust in the dexterity and quality control of our employees.

A majority of the components are also developed in Germany or in neighbouring European countries especially for our high performance and durability requirements. When selecting our components, we place the highest value on quality, durability, origin and efficiency. System-relevant components are subjected to a full check in order to reduce the probability of an electronic defect to 0 as much as possible. All components we use are specially developed for our needs and guarantee unsurpassed product quality.





CUSTOMER SERVICE

Our lighting systems are not disposable products. In the event of a defect, we'll repair it, even long after the end of the usual warranty. To help get your lights up and running again as quickly as possible, we guarantee processing within 48 h and the availability of replacement parts for up to 10 years after buying your lamp.

The cost of repairing a device is usually significantly lower than the cost of replacing it. A repair in no way changes the quality of a product – but it does reduce the environmental impact it would have as rubbish while simultaneously protecting your wallet.

In contrast to comparable products, permanent adhesive solutions are deliberately avoided even during the development phase. Our lamps are designed to be easy to take apart, repair and put back together again.

PRODUCT PORTFOLIO

Lupine – that means a full range of lighting systems for just about any outdoor activity. Whether it's an e-bike, s-pedelec, bike, MTB or the headlamp or flashlight for your next adventure, we guarantee you will find the right lighting to extend your day. Depending on your needs, you can choose between different performance classes, light patterns, battery lifetimes, brackets, weights and sizes.

What about snow? Rain? Mud and muck? – No problem. Whether it's a headlamp, battery, flashlight, bike light or a safety light, our lights are made to survive almost all extreme conditions at night. Our lamps and rechargeable batteries are impact resistant, waterproof and can be used in ambient temperatures from -25 °C to +70 °C.





BIKE LIGHTS

SL AX
16 - 19

SL AF
20 - 23

SL NANO AF
24 - 27

ROTLICHT
30 - 33

C14 MAG
34 - 37



SL AX

THE BRIGHTEST BIKE LIGHT OUT THERE- MADE BY LUPINE

The new SL AX is safety – safety during the day and safety at night. But it is also an extremely powerful light, perfect for quick trips and, with a full beam of up to 2200 lumens, currently the brightest bike light permissible by the German Road Traffic Act.



reddot winner 2021



SL AX

THE BEST OF BOTH WORLDS

You switch to high beam, the SL X opens a bright corridor far above the glare-free cut-off line and lights up the 9 automotive LEDs of the main headlamp to the maximum. What's unique here is that the daytime running light is activated at the same time with significantly increased output. Its 6 LEDs and ingenious Fresnel lens system increase the light output and create close-range illumination with which you can also playfully master the quick descents and the technical root passages.

DAYTIME RUNNING LIGHT

The SL AX daytime running light is particularly bright and guarantees the full attention of all other road users thanks to the distinctive signature of the daytime running light.







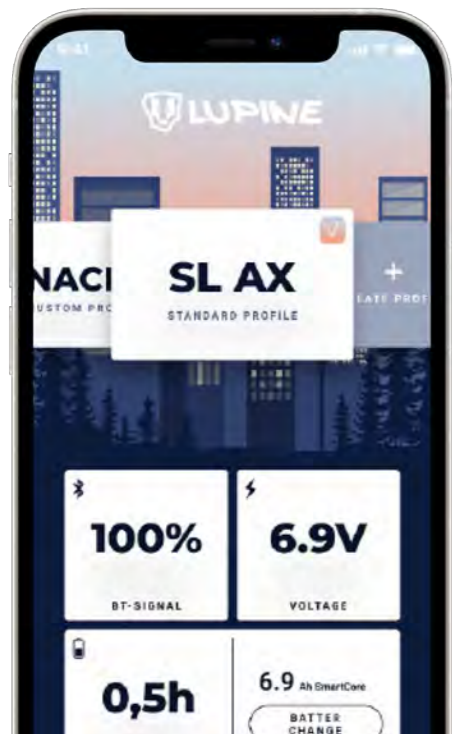

SENSOR SYSTEM

The stereo sensor system, which can be adjusted incrementally, scans the ambient light in real time and switches your SL X from daytime running light to low beam at the right time. At the same time, the sensor system releases the full beam function.

APP AND REMOTE CONTROL

You can control your SL AX with your Bluetooth remote control or via your smartphone or smartwatch using the new app. But our app is much more than just an alternative remote control, it makes setting the lamp functions much easier.



 2200LM MAX 340 LUX	 30W MAX POWER	 370m BEAM DISTANCE	 160G LAMPHEAD
 45 x 85 x 48mm SIZE	 BLUETOOTH REMOTE CONTROL	 BEAM PATTERN	 BRIGHTNESS- & MOTION SENSOR

SL AF

"F" STANDS FOR FULL BEAM - THE SL F WITH ITS OWN BATTERY

The sensor-controlled "daytime running light" and the glare-free 1000 lumens low beam will get you safely through traffic at any time of day. At the push of a button, you can unleash the 1300 lumens full beam and let your bike loose on country roads, forest roads and demanding trails.



SL AF

LIGHT FOR EVERY SITUATION

As dusk falls, the SL automatically switches from „daytime running light“ to low beam and guides you safely through traffic without any glare. Away from the city, press the button on your Bluetooth remote control and unleash the power of the 1300 lumens full beam.

A CARPET OF LIGHT

In contrast to other bicycle lights approved by the German Road Traffic Act, the light pattern of the SL F is not limited to illuminating a narrow sliver of road, rather it casts a broad and homogenous carpet of light right in front of your front wheel.









LIGHT. YEARS AHEAD

The 18 Osram Compact CL Automotive LEDs and the first ever Dual Aspheric Lens system for bike lights in the world are the core of the Lupine SL AF. The material used for the lenses is extremely weather-resistant and is also used in aviation and medical technology, among other things. The extremely robust and high-quality aluminum body reliably protects the SL AF from impacts, dust and water.

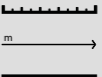
BLUETOOTH REMOTE CONTROL

Everyone has had this experience: it's night, the road is clear, you turn on your full beams and put your foot down. This is the exact feeling the SL AF gives you on your bike. Using the two buttons on the Bluetooth remote control, you can turn the lights on and off in a fraction of a second or switch through the lighting levels of the low beam.



 1300LM MAX 110 LUX	 16W MAX POWER	 210m BEAM DISTANCE	 100G LAMPHEAD
 49 x 50 x 48mm SIZE	 BLUETOOTH REMOTE CONTROL	 BEAM PATTERN (INTERNATIONAL VERSION AVAILABLE)	 BRIGHTNESS SENSOR

SL NANO AF

THE SMALL ONE FOR THE STREETS

The SL Nano AF is our smallest German Road Traffic Act-approved bicycle lamp. With its 700 lumens dipped beam, you can move safely through the streets without blinding oncoming traffic. Out of town, you can switch to the 1100 lumens full beam with your Bluetooth remote and illuminate country roads, dirt tracks and trails.



SL NANO AF

SMALLER, LIGHTER, STRONGER, BETTER LOOKING

The SL Nano is the smallest, brightest and we think it's also the best looking lamp in its category. The lightweight device, which weighs just 52 g, lights the way in a totally German Road Traffic Act-compliant way – whether in full beam, low beam or daytime driving mode.

WITH GLARE-FREE LOW BEAM

When it gets dark, the Nano automatically switches from „daytime running lights“ to low beam. The glare-free low beam of the SL Nano provides an impressive 700 lumens of illumination and thus beats every comparable lamp of its size. The illumination from the low beam is extremely even, allowing you to recognise obstacles in your visual range with ease.

AND FULLBEAM

1100 lumens of full beam from such a small lamp seem almost unbelievable. With the Bluetooth remote control, you can quickly switch between low beam and full beam or dim your current light level.

FULL FOCUS

The SL Nano owes its uniform light pattern and its enormous light output in relation to its size to sophisticated lens technology. The polycarbonate look combines complex free-form surfaces with Fresnel elements, creating a quality of illumination that is unrivalled in this class.



1100LM MAX
140 LUX



14W MAX
POWER

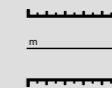

240m
BEAM DISTANCE



52G
LAMPHEAD

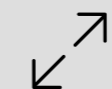

41 x 30mm
SIZE



BLUETOOTH
REMOTE CONTROL



BEAM PATTERN



BRIGHTNESS- &
MOTION SENSOR

OVERVIEW

LAMPSETS BIKE LIGHTS

LIGHTTEST:

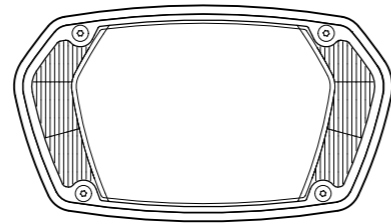

SL AX

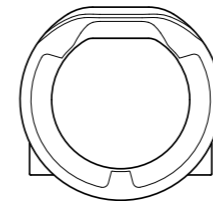

SL AF

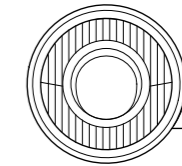

SL NANO AF

LIGHT OUTPUT

BLUETOOTH

BATTERY

MOUNT

OPTIONAL MOUNT

APPROVAL

SENSOR

STRENGTH

LEDs

SIZE

WEIGHT

2200 Lumens

With Bluetooth remote control

With 6.9Ah or 10.0Ah battery

Quick release (25.4mm, 31.8mm, 35mm)

SmartphoneHub, Aero, GoPro, Twinfix, Classic

StVZO

Brightness-, & motion sensor

High beam distance & High light output

Osram Compact PL, Compact CL

45 x 85 x 48mm

160g

1300 Lumens

With Bluetooth remote control

With 3.5Ah or 6.9Ah battery

Quick release (25.4mm, 31.8mm, 35mm)

Flexmount, Aero, GoPro with Spacer, Twinfix

StVZO

Brightness sensor

Wide, homogeneous beam pattern

Osram Compact CL

49 x 50 x 48mm

100g

1100 Lumens

With Bluetooth remote control

With 3.5Ah or 5.0Ah battery

Quick release (25.4mm, 31.8mm, 35mm)

Newmen, Aero, GoPro

StVZO

Brightness-, & motion sensor

Extremely small and light weighted

Osram Compact PL

41 x 30mm

52g

ROTLICHT

ON THE BRAKES, READY, RED

Sensor-controlled brake light, brightness sensor, a high-quality aluminium case, robust front lid, powerful 160 lumens and lighting duration of up to 30 hours: you won't find a rear light like this Rotlicht anywhere else.



ROTLICHT

BRAKE LIGHT

The brake light, which reacts immediately and makes the Rotlicht brighter when you hit the brakes, provides additional safety. The sensitivity of the sensor can be adjusted. The high-quality aluminium case and the robust polycarbonate front lid are extremely durable and protect the red light from impacts, dust and water.

VARIOUS FEATURES

You are on the road and a vehicle is coming behind you? A brightness sensor recognizes at any time how much light you need and adjusts the brightness of your taillight. So you are always perfect to see even in strong ambient light and automatically save power when you just need less. To increase your visibility even more the international version of the Rotlicht comes with several lighting features like pulsing, flash and more.

SEAT RAIL MOUNT

The seat rail mount ensures secure and tidy attachment. You can remove the light from the holder with just one click to charge it or stop it from being stolen when leaving your bike in a bike rack.



ROTLICHT OR ROTLICHT MAX

Rotlicht or Rotlicht Max? This question is easy to answer: When battery life becomes more important than weight, the Rotlicht Max is your first choice. The Rotlicht Max is our red light with extra large battery and doubled runtime.



160 LUMENS



0.1W - 2W
POWER



55G
WEIGHT



20 x 32 x 60mm
SIZE



30H
RUNTIME



IP68 / K09

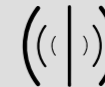

BRIGHTNESS-, &
MOTION SENSOR

C14 MAG

MAGICALLY MAGNETIC

45 lumens, integrated rechargeable battery, brake light, brightness sensor and a hitherto-unseen innovative magnetic holder for mounting on the seat rail – the C14 Mag is all this and more.



C14 MAG

MAGNETICALLY SECURE

The C14 Mag holds securely – and with pure magnetic force. The CNC-milled seat rail bracket is simply screwed in place under the saddle. The C14 Mag can now be attached or removed in a fraction of a second, whether to charge it or to prevent it from being stolen.

MAGNETICALLY CHARGED

The C14 Mag provides perfect visibility in any situation for up to 22 hours. And if the battery is empty, simply attach your rear light to the blue-lit magnetic charger to charge it again.

BRAKE LIGHT

Wouldn't it be nice if you could warn the person behind you before you hit the brakes? No problem – if you need to make a braking manoeuvre, a G-sensor reliably detects your movement and briefly makes the C14 Mag brighter. The brake light function is extremely precise and guarantees extra safety.

BRIGHTNESS SENSOR

The C14 Mag has a button that is easily accessible while riding your bike. However, if you want to focus solely on riding your bike, you can also rely on the automatic mode. A brightness sensor scans the ambient light levels and activates your rear light as soon as you need it to be seen.



45 LUMENS



0.2 - 0.5W STEADY LIGHT
0.75W BRAKE LIGHT



60G
WEIGHT



70 x 40 x 23mm
SIZE



22H
RUNTIME



IP68 / K09



BEAM PATTERN



BRIGHTNESS-, &
MOTION SENSOR



E-BIKE LIGHTS

SL X

40 - 43

SL F

44 - 47

SL NANO

48 - 51

C14

54 - 57

Compatibility:



SL X

SAFETY AND POWER – FOR PEDELECS AND S-PEDELECS

The new SL X is safety – safety during the day and safety at night. But it is also an extremely powerful light, perfect for quick trips and, with a full beam of up to 1800 lumens, currently the brightest e-bike and s-pedelec light permissible by the German Road Traffic Act*.

*S-Pedelec-Version: 2100 Lumens



SL X

THE BEST OF BOTH WORLDS

You switch to high beam, the SL X opens a daylight corridor far above the glare-free cut-off line and lights up the 9 automotive LEDs of the main headlamp to the maximum. What's unique here is that the daytime running light is activated at the same time with significantly increased output. Its 6 LEDs and ingenious Fresnel lens system increase the light output and create close-range illumination with which you can also playfully master the quick descents and the technical root passages.

DAYTIME RUNNING LIGHTS

The SL X daytime running light is particularly bright and guarantees the full attention of all other road users. The SL X is currently the only German Road Traffic Act-approved Lupine light with a real daytime running light function, tested according to ECE R87.

SENSOR SYSTEM

The stereo sensor system, which can be adjusted incrementally, scans the ambient light in real time and switches your SL X from daytime running light to low beam at the right time. At the same time, the sensor system releases the full beam function.









FOR ALL CURRENT E-BIKE MOTORS

The SL X needs power. Fortunately, most current motors can supply this power. The SL X is compatible with Bosch Gen4, Shimano Ep8, Brose, Specialized and more. (More details can be found in our compatibility list)

ALSO FOR S-PEDELECS

The S-pedelec version of the SL X offers up to 2100 lumens of high beam and all the features of the e-bike version. A special feature here is the operating voltage: The SL X for S-pedelecs can be operated with voltages from 24V-60V and is therefore maximum flexible to install and use.



 1800LM MAX 260 LUX	 6 - 15V	 290m BEAM DISTANCE	 170G LAMPHEAD
 45 x 85 x 48mm SIZE	 WIRED REMOTE CONTROL	 BEAM PATTERN	 BRIGHTNESS- SENSOR

SL F

"F" STANDS FOR FULL BEAM – THE SL F FOR E-BIKES

The sensor-controlled "daytime running light" and the glare-free 1000 lumens low beam will get you safely through traffic at any time of day. At the push of a button, you can unleash the 1300 lumens full beam and let your bike loose on demanding trails.



SL F

LOW BEAM AND FULL BEAM

The SL F's low beam has been designed according to the example of car headlights and is completely glare-free for other road users coming the other way. The SL F's 1300 lumens full beam isn't just a more powerful low beam. At the push of a button, the entire lighting pattern changes and lights up an additional area far above the glare-free light-dark boundary: perfect for fast journeys and demanding trails.

LIGHT FOR EVERY SITUATION

As dusk sets in, the SL switches automatically from "daytime running light" to "low beam" and shows the way through traffic safely and without glare. Outside of the city, press the remote control button and unleash the full 1300 lumens full beam.









BUTTON

Everyone has had this experience: it's night, the road is clear, you turn on your full beams and put your foot down. This is the exact feeling the SL F gives you on your bike. With the wired remote control, specially developed for e-bikes, you can switch your light on or off in a fraction of a second.

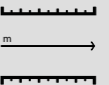
A CARPET OF LIGHT

In contrast to other bicycle lights approved by the German Road Traffic Act, the light pattern of the SL F is not limited to illuminating a narrow sliver of road, rather it casts a broad and homogenous carpet of light right in front of your front wheel.



 1300LM MAX 110 LUX	 6 - 15V	 210m BEAM DISTANCE	 100G LAMPHEAD
 49 x 50 x 48mm SIZE	 WIRED REMOTE CONTROL	 BEAM PATTERN	 BRIGHTNESS- SENSOR

SL NANO

THE SMALL ONE FOR THE STREETS

The SL Nano is the smallest, brightest and we think it's also the best looking lamp in its category. The lightweight device, which weighs just 52g, lights the way in a totally German Road Traffic Act-compliant way and gets its power straight from your e-bike's light output. The glare-free low beam of the SL Nano provides an impressive 600 lumens of illumination and thus beats every comparable lamp of its size. Thanks to the wired remote control, developed specially for e-bikes, you'll be able to switch to the 900 lumens full beam and back to the low beam when required in a fraction of a second.



SL NANO

SMALLER, LIGHTER, BETTER LOOKING, STRONGER

The SL Nano is the smallest, brightest and we think it's also the better looking lamp in its category. The lightweight device, which weighs just 52g, lights the way in a totally German Road Traffic Act-compliant way and gets its power straight from your e-bike's light output, and is compatible with nearly all e-bike motors.

FULL FOCUS

The SL Nano owes its uniform light pattern and its enormous light output in relation to its size to sophisticated lens technology. The polycarbonate look combines complex free-form surfaces with Fresnel elements, creating a quality of illumination that is unrivalled in this class.

UNIVERSAL CLAMP

The SL Nano is mounted directly onto the handlebar with a two-piece holder clamp as standard. The holder itself is made from CNC-milled aluminium, has been anodised black and holds the Nano firmly in place even under heavy impact.

CLASSIC MOUNT









Mounting directly onto the fork crown is a good option, especially for city pedelecs and e-trekking bikes. The Classic Mount version of the Nano is mounted just above the mudguard and thus creates space for a bike computer, mobile phone or a shopping basket on the handlebar.

NEWMEN

Developed together with Newmen Components, the SL Nano can be integrated into your stem. The Newmen version of the SL Nano is held directly by the stem clamps on the handlebars – perfectly centred, secure, tidy and clean.*

*compatible with all 4 screw-stems from Newmen (Evolution 31.4)



 900LM MAX 130 LUX	 5 - 15V	 230m BEAM DISTANCE	 52G LAMPHEAD
 41 x 30mm SIZE	 WIRED OR BLUETOOTH REMOTE CONTROL	 BEAM PATTERN	 BRIGHTNESS- SENSOR

OVERVIEW

LAMPSETS E-BIKE LIGHTS

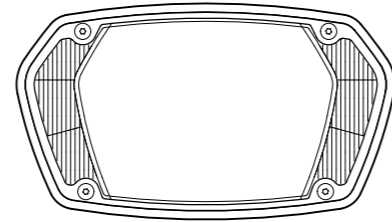

SLX

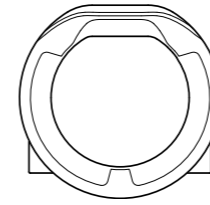

SLF

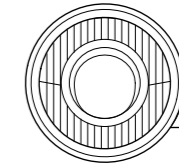

SL NANO

COMPATIBILITY:



LIGHT OUTPUT

BLUETOOTH

BATTERY

MOUNT

OPTIONAL MOUNT

APPROVAL

SENSOR

STRENGTH

LEDs

SIZE

WEIGHT

1800 Lumens

Wired remote control

6 - 15V (S-Pedelec 24 - 60V)

CNC barmount (25.4mm, 31.8mm, 35mm)

SmartphoneHub, Aero, GoPro, Twinfix, Classic

StVZO

Brightness sensor

High beam distance & light output

Osram Compact PL, Compact CL

45 x 85 x 48mm

160g

1300 Lumens

Wired remote control

6 - 15V

CNC barmount (25.4mm, 31.8mm, 35mm)

Flexmount, Aero, GoPro mit Spacer, Twinfix

StVZO

Brightness sensor

Wide, homogeneous beam pattern

Osram Compact CL

49 x 50 x 48mm

100g

900 Lumens

Wired or bluetooth remote control

5 - 15V

CNC barmount (25.4mm, 31.8mm, 35mm)

Newmen, Classic, Aero, GoPro

StVZO

Brightness sensor

Extremely small and light weighted

Osram Compact PL

41 x 30mm

52g

C14

THE FIRST REAR LIGHT FOR E-BIKES INTEGRATED INTO THE SADDLE CLAMP.

There are saddle clamps and there are rear lights, and now you can get both in one – Lupine C14. The extraordinarily powerful 45 lumens rear light is fully integrated into the saddle clamp. Thanks to the latest COB technology and high-performance Fresnel lenses, the C14 can achieve an all-round high level of visibility while simultaneously reducing glare. The special arrangement of the 14 LEDs and a sophisticated lens system also create unprecedented, homogeneous lighting characteristics.



C14

PART OF YOUR BIKE

The C14 combines anti-theft protection and visual appeal like no other: the unique integration of the rear light into the saddle clamp makes the C14 an integral part of your bike.

FOR EVERY E-BIKE

Bosch, Shimano, Brose, Yamaha: the C14 is connected directly to the motor of your e-bike and is compatible with all current e-MTBs. Use of the C14 is approved for all e-bikes up to 25 km/h, in accordance with the German Road Traffic Act.

ON THE SEAT POST

In some cases, for example if your saddle clamp is positioned very low, it may make sense to install the C14 directly on the seat post itself. We have developed the C14 SP for this purpose. The two-piece C14 SP holder clamp allows for quick and easy installation without having to dismantle the seat post.



OR LUGGAGE RACK

As another alternative to the saddle clamp, the C14 G can also be mounted on standard luggage racks.



45 LUMENS



6 - 15 V



35G
LAMPHEAD



DIAMETER
31.8, 34.9, 35.6,
36.4, 38.6mm



IP68 / K09



BEAM PATTERN



HEAD & HELMET LIGHTS

PENTA

60 - 63

NEO

64 - 67

PIKO

68 - 71

BLIKA

72 - 75

WILMA

76 - 79

BETTY

80 - 83

ALPHA

84 - 87

PENTA

A LAMP FOR DAY-TO-DAY USE, BUILT FOR THE EXTREME

An 86-g compact headlamp with an integrated battery from Lupine. Its light output* of up to 1100 lumens is perfect at close range and for any work, any use and all types of sport at a moderate speed. It even shines in cold or adverse conditions with excellent handling, perfect ergonomics and additional lighting functions such as red and diffuse light. A high-quality aluminium case reliably protects the inner parts from impacts, dust and water (IP68).

*Boostmode



PENTA

FOR YOUR SPORT

The Penta's light pattern is softer and wider, making it perfect for sports like running, climbing, mountaineering or just about any activity where it's important to see what's happening right in front of your feet. Also available for any athlete, we recommend the headband with adjustable top band for a better hold under strenuous activity.

FOR YOUR FREEDOM

Hot or cold, rain or snow – with the Penta you don't need to worry about the weather but only about what's important: you, your activity, your night, your freedom. The Penta is waterproof, impact resistant and, with dimensions of just 62 x 46 x 30mm and a weight of just 86 g*, perfect when it comes to keeping your backpack small.









FOR YOUR ADVENTURE

Whether you're pitching your tent, bivouacking, building a fire or making tea on your gas cooker: the diffuse light, which can be adjusted incrementally, shows its strengths in such situations. Double-click to fire the Penta up to 1100 lumens at any time to scan your surroundings, and best of all, the Penta will light even while charging, if you want it to.

FOR OUR ENVIRONMENT

Let's not kid ourselves: every product consumes resources. In order to keep the impact on the environment as low as possible, we do not make any disposable products; rather, we ensure during development that all system-relevant parts can be easily replaced when they reach the end of their life after a few years or when the battery needs to be replaced.



 1100LM MAX. 38 LUX	 6W MAX. POWER	 86G LAMPHEAD	 120m BEAM DISTANCE
 1H - 120H RUNTIME	 62 x 46 x 30mm SIZE	 IP68 / K09	 CHARGING WITH USB C

NEO

SMALL LAMP, BIG OUTPUT

The 1000 lumens Neo includes the full range of Lupine technology in the smallest lamp we've ever built: active heat management, five different lighting modes, numerous additional functions and a high-quality, stable aluminium case.



NEO

PERFECT USE

The Neo headlamp is with up to 80 hours runtime, amazing 1000 lumens and its perfectly designed light pattern the ideal companion for mountaineering, hiking, running, ski touring or working at night.

PERFECT ILLUMINATION

When developing the Neo, we placed particular emphasis on optimal light distribution and long-lasting, high light output. Thanks to the broad angle of the edge of the light, you can see your surroundings perfectly. The narrow central spotlight provides you with an excellent lighting range of more than 140 metres, and the accompanying diffuser provides reduced glare and a softer light.

INDIVIDUALLY ADJUSTABLE

The Neo offers you a choice of five pre-programmed lighting modes. With the push of single button, you can easily switch between 2-stage, 3-stage or 4-stage mode and the integrated red light. Other functions such as SOS or the Alpine emergency signal are also available.

LESS IS MORE

The impressive 1000 lumens generated by the Neo are delivered from a single latest-generation CREE XM-L3 chip. A red light and a particularly effective lens have also been integrated for the unobtrusive reading of maps. The Neo weighs just 50 grams and you will barely notice you are wearing it on your head, even after wearing it for a long time.



1000LM MAX.
55 LUX



10W MAX.
POWER



50G
LAMPHEAD

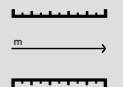

140m
BEAM DISTANCE



INTEGRATED
RED LIGHT



32 x 40 x 32mm
SIZE



IP68 / K09

PIKO

SMALL, LIGHT, BRIGHT - REDEFINED

The Piko headlamp is extremely small and light, but also robust and bright enough for any situation, no matter how extreme. The third generation of the Piko uses its full 2100 lumens and has a self-contained diffuse reading and camping light. Its CNC-milled aluminium body has been completely redesigned and is 3mm shorter than before. This brings the centre of gravity of the 60g Piko closer to your head, which makes it even more comfortable to wear for extended periods.



PIKO

PERFECTED OVER GENERATIONS

The Piko: the established headlamp of the mountain rescue service, a sought-after bike lamp and for years unrivalled when it comes to achieving as much light as possible with as little weight as possible and with a minimal size. But how do you improve an already unbeaten headlamp? You redevelop it – make it more functional, brighter, refine its look and do it all with attention to detail.

DIFFUSE READING AND CAMPING LIGHT

The diffuse reading and camping light is perfect for situations like camping, reading and repair work. The light itself is particularly soft and even. Its colour temperature is particularly warm compared to the main headlamp, making it especially pleasant for close-range activities.







IMPROVED HEAT MANAGEMENT

With a lamp as small and bright as the Piko, heat management and the integration of an additional reading light are a major challenge. Thanks to state-of-the-art materials and optimised software, the heat dissipation and dimming behaviour of the Piko have been significantly improved. That means that, even with little airflow or a lamp that is already warm, you now have visibly more light than before.

BLUETOOTH AND APP

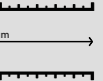
With the optional integrated Bluetooth module, you are no longer limited to controlling the Piko via the button on the lamp head, you can now also use the Bluetooth remote control or free mobile app.



 2100LM MAX. 115 LUX	 20W MAX. POWER	 60G LAMPHEAD	 215m BEAM DISTANCE
 BLUETOOTH & APP POSSIBLE	 INTEGRATED DIFFUSE LIGHT	 32 x 43 x 26mm SIZE	 IP 68 / K09

BLIKA

ONE LIGHT FOR EVERY ADVENTURE

There are lights for running, lights for climbing, lights for your bike and one for every adventure. A gigantic 2400 lumens, close range and full beam functions, red and green light, a soft reading light and the FrontClick changing system make the Blika the most versatile Lupine light we have ever constructed.



BLIKA

MULTISPORT

There are lights for running, lights for climbing, lights for your bike and one for just about any of your adventures: When developing the Blika, we asked ourselves what a lamp has to be able to do in order to facilitate the widest possible range of activities at night and combined all of these into a single lamp – the Lupine Blika.

NOW EVEN COOLER

Wherever there is light, there is heat, and that heat has to go. In order to keep the Blika efficient for even longer, we have massively improved the cooling of the lamp head. That means that, even with little airflow or a lamp that is already warm, you now have visibly more light than before.

AND BETTER

A spotlight providing twice as much light for more range, a more even reading, red and green light. The new Blika is better than its predecessor in every respect. Based on the popular Piko lighting configuration, the Blika has a switchable, narrow spotlight, which provides a range improved many times over. Red and green lights make it possible to carry out the most specific activities, and the diffuse reading and camping light is perfect when a softer light is needed.

TWO BUTTONS - FULL CONTROL

To make operating the Blika as straightforward as possible, we designed an innovative operating system with two buttons which can be assigned independently of each other. That means you have direct access to all lighting levels and special functions at all times. You also have the option of using the Bluetooth remote control and app.



2400LM MAX.
150 LUX



26W MAX.
POWER



85G
LAMPHEAD

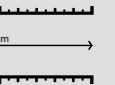

255m
BEAM DISTANCE



BLUETOOTH
& APP POSSIBLE



INTEGRATED
DIFFUSE-, RED-, &
GREENLIGHT



33 x 51 x 33mm
SIZE



IP68 / K09

WILMA

NIGHT WANDERER

With 3600 lumens, you can identify every stone on your path, even when moving quickly and under difficult conditions. Wilma: an extremely bright light for extreme speeds and activities at night – Bluetooth and remote control included.



WILMA

A NEW LAMP

We have steadily improved our Wilma, which has proven itself for years. Its high-quality aluminum body has become more robust, more beautiful and, thanks to more cooling fins and our FrontClick system, significantly more functional. Its light pattern has been made more harmonious, its performance increased. This and more makes the current generation of the Wilma your perfect companion for every night, no matter how crazy.

A NEW NIGHT

Unbelievable 3600 lumens, which is brighter than traditional car headlights. Such powerful output and a perfectly balanced lighting configuration make it possible for you to carry out quick, extreme or other such difficult activities at night. Regardless of whether you want to master the descent of a lifetime while skiing or push yourself to your mountain biking limits. The light of Wilma has none.

INDIVIDUALLY ADJUSTABLE

The Wilma lamp head offers 10 different dimming levels and numerous additional functions, including SOS, FLASH, RVLIR and the Alpine emergency signal. With the single press of a button, you can switch between the levels, display the remaining battery life or combine up to 4 lighting levels in any order and create your own personal lighting programme.

WITH BLUETOOTH AND APP

With the integrated Bluetooth module, you are no longer limited to controlling the Wilma via the button on the lamp head, you can now also use the Bluetooth remote control or free mobile app.



3600LM MAX.
200 LUX



28W MAX.
POWER



120G
LAMPHEAD

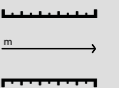

285m
BEAM DISTANCE



BLUETOOTH
& APP



50 x 50mm
SIZE



IP68 / K09

BETTY

A FLOODLIGHT ON YOUR HEAD

Switch on and be amazed: a blinding 5400 lumens, a range of up to 360 metres, an elegant and extremely robust aluminium case, a special lens design for the perfect beam of light, and enough power to illuminate entire valleys. Even today, our Betty is still showing why it earned the title of “benchmark in helmet and head lamps” until the Alpha was released.



BETTY

FASCINATION BETTY

Switch it on and be amazed. 5400 lumens and a range of up to 360 meters – as good and bright as it gets. A beautifully designed and extremely robust aluminium case, a special lens arrangement for perfect illumination and enough output to illuminate entire valleys. Our Betty is the absolute maximum technology can achieve.

NO COMPROMISES

In order to produce the brightest head lamp in the world, we first asked what makes a headlamp – a strong yet light housing, high-performance LEDs, an effective lens system and ease of use. For Betty, we wanted to get the best out of all the components. To do that, we redefined the limits of technology and created something special. A lamp without compromise.







INDIVIDUALLY ADJUSTABLE

With the Betty lamp head, you have 11 different dimming levels and numerous additional functions at your disposal, including Centre LED, SOS, FLASH, RVLR and the Alpine emergency signal. By pushing the button on the lamp head, you can switch between the levels, display the remaining capacity or combine up to 4 light levels in any order and create your own personal light program.

WITH BLUETOOTH AND APP

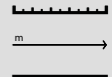
With the integrated Bluetooth module, you are no longer limited to controlling the Betty via the button on the lamp head, you can now also use the Bluetooth remote control or free mobile app.



 5400LM MAX. 320 LUX	 45W MAX. POWER	 150G LAMPHEAD	 360m BEAM DISTANCE
 BLUETOOTH & APP	 INTEGRATED RED CENTER LED	 55 x 44mm SIZE	 IP68 / K09

ALPHA

THE NEW MAXIMUM

The new Lupine Alpha is our most powerful bike light for racing and is now even brighter. An incandescent 8000 lumens, perfect illumination at close and far range and an enormous range of up to 480 metres turn every bike into the ultimate night-time racing machine.



ALPHA

PURE POWER

Whether it's right in front of the front wheel or several hundred metres away: with the Alpha, you can really see every detail on your trail. The Alpha combines 3 different types of lens into a light configuration perfectly tailored for racing use. Two 22° lenses work in combination with two ultra-wide-angle lenses for a level of close-range illumination never achieved before. Four 18° lenses focus part of the light and generate a range of lighting that leaves every comparable light in the shadows.

REDUCED TO THE ESSENTIALS

Wherever there is light, there is heat. To optimise the cooling of the Alpha we have completely redesigned it. New, more aggressive housing, more cooling fins and a completely new interior make the Alpha not only fit for more lumens but probably the most powerful MTB lamp on the market.









LED BAR

To make sure that you can immediately see the level at which your lamp is currently operating, even at top speed, an extra-large, coloured LED status bar has been integrated into the Alpha to display the lighting levels and functions.

BLUETOOTH UND APP

With the 2-button Bluetooth remote control on the new Alpha, you can now switch between the lighting levels even more easily – directly from the handlebar. You can switch back and forth between the lighting levels at lightning speed, similar to a gear box. You can set lighting levels and create your own custom profiles using our free smartphone app.



 8000LM MAX. 570 LUX	 70W MAX. POWER	 225G LAMPHEAD	 480m BEAM DISTANCE
 BLUETOOTH & APP	 DAYTIME RUNNING LIGHT	 77 x 55 x 42mm SIZE	 IP68 / K09

MOUNTS

FRONTCCLICK

Why don't we distinguish between helmet and head lamps? It's quite simple: with the FrontClick quick-change system, you are more flexible than ever before. You can turn your head lamp into a helmet lamp or swap your lamp head from one helmet to the next in just a few seconds and without any tools.



HELMET MOUNT

With hook-and-loop fastener



HEADBAND

black, olive, Heavy Duty



HELMET MOUNT

with 3M glue pad



HELMET MOUNT

Wilcox



HELMET MOUNT

Goggle



BAR MOUNT

Ø 31.8mm and 35 mm

ACCESSORIES

USB ONE

The USB One transforms any Lupine battery into a mobile power bank. It can then be used to charge almost any USB device within a very short period of time. The USB TWO, on the other hand, charges your smartphone directly from the Lupine battery while simultaneously providing the light with power.



USB CHARGER

With the USB charger you can easily charge any Lupine battery using the USB port on a PC, laptop or power pack. This small charging device, just a few centimetres in size, provides up to 1 amp – that's more than fast enough to charge your battery during work hours, for example.



LUPINE APP

FOR IOS & ANDROID



LUPINE LIGHT CONTROL 2.0

You have countless options with the **Piko, Blika and Alpha** thanks to this app: assign lighting levels and special functions to whichever button you want. Save the settings, create individual profiles for different activities and simply use them whenever you need them. This way, you're perfectly prepared for any type of sport – simply select the profile you've created and activate the light.

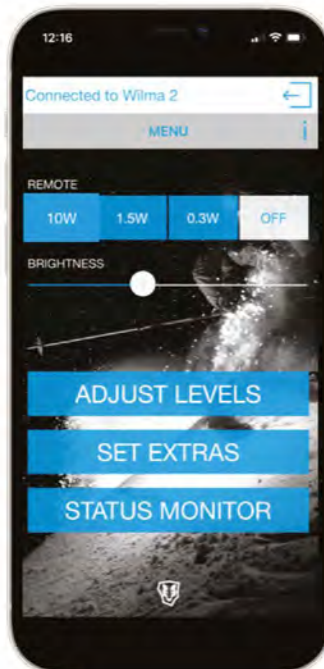

LUPINE LIGHT CONTROL

Lupine Light Control connects **Wilma or Betty** with your smartphone. With just a few swipes, you can specify how bright you want your light to be at individual levels, add additional levels or use numerous special functions.

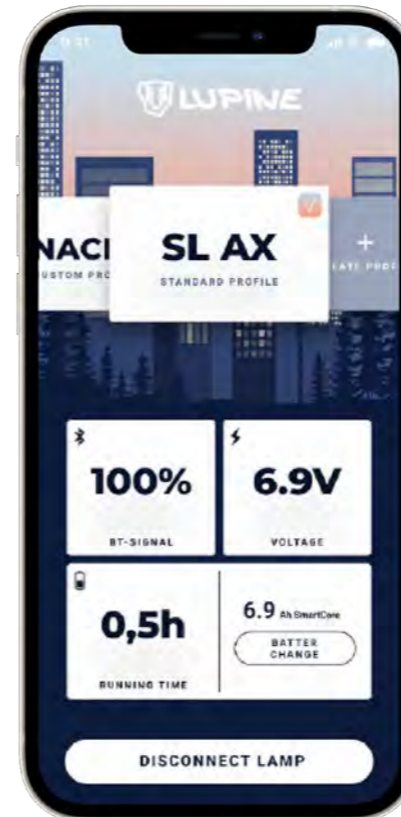

THE NEW APP FOR YOUR SL AX

The new **SL AX** app makes setting lamp functions much easier: sensors, lighting levels and special functions can be set almost* however you want and saved as your own profile. You can also use your smartwatch to directly control your lamp, read the expected battery life or change the profile.
*Within the scope of the German Road Traffic Act

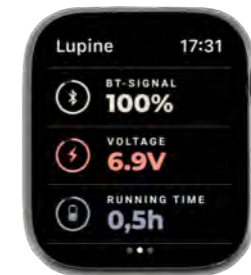

OVERVIEW

LAMPSETS HEAD- & HELMETLAMPS

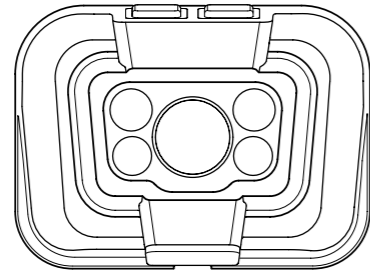

PENTA

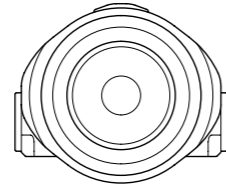

NEO

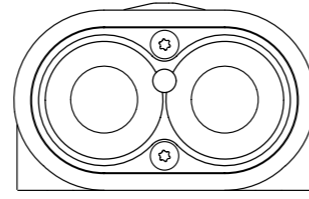

PIKO

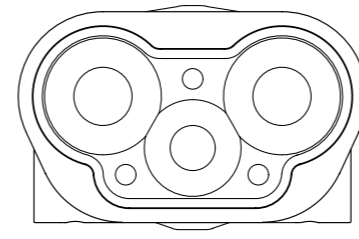

BLIKA

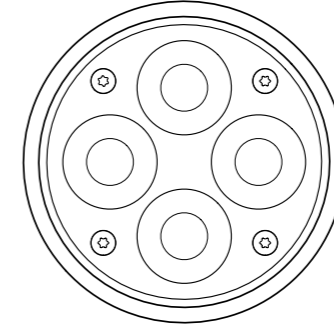

WILMA

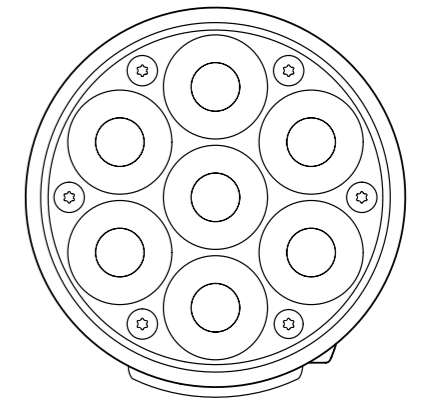

BETTY

LIGHTTEST:



LIGHT OUTPUT	1100 Lumens	1000 Lumens	2100 Lumens	2400 Lumens	3600 Lumens	5400 Lumens
BLUETOOTH	No	No	Yes (optional)	Yes (optional)	Yes	Yes
APP	No	No	Yes (optional)	Yes (optional)	Yes	Yes
BATTERY	Integrated, 1.8Ah	2.0Ah, 3.5Ah	2.0Ah, 3.5Ah, 6.9Ah	3.5Ah, 6.9Ah	3.5Ah, 6.9Ah	3.5Ah, 6.9Ah
LAMPSET	Headlamp	Head-, & Helmetlight	Head-, & Helmetlight, All in One Set	Head-, & Helmetlight, All in One Set	Head-, & Helmetlight	Head-, & Helmetlight
MOUNT	FrontClick optional	FrontClick	FrontClick	FrontClick	FrontClick	FrontClick
SPECIAL FEATURE	Diffuse-, and Redlight	Redlight	Diffuselight	Diffuse-, Red-, Greenlight	-	Red Center LED
LEDs	Cree XP-G2, Cree XQ-E Hi	Cree XM-L3	Cree XM-L3, XQE-Hi	Cree XM-L3, XQ-E HI (green, white, red)	Cree XM-L3	Cree XM-L3, XP-E2
PROTECTION CLASS	IP68 / K09	IP68 / K09	IP68 / K09	IP68 / K09	IP68 / K09	IP68 / K09



FLASH LIGHTS

PIKO TL

96 - 99

BETTY TL 2

100 - 103

BTL 2 PRO

104 - 107

PIKO TL

MAXIMUM MINIMUM

Piko TL: that's maximum output at minimum size and a popular design for years. The light and compact flashlight is made from black anodised aluminium and shines with a fabulous 1600 lumens. Piko TL is a high-tech flashlight, smaller than a smartphone and perfect for your trouser pocket.



PIKO TL

ALWAYS AT HAND

With the Piko flashlight, you'll always have a light with you. It is small and light enough that you can carry it comfortably in your pocket or on your belt. 2 high-power LEDs illuminate the PTL to a maximum of 1600 lumens – bright enough to provide you with enough light in any night-time situation. Its extremely robust yet elegant aluminium body reliably protects against impacts, dust and water.

TWO VERSIONS

The Piko TL is available in two different sizes. The Piko TL Max is just 1.3 cm longer than the Piko TL MiniMax but has 65% more battery capacity: 3.3Ah battery / Piko TL MiniMax: 2.0Ah battery

ALUMINIUM HOUSING

To make the Piko TL as robust and light as possible, we use a particularly high-quality aluminium body and a main element milled from one piece. We have designed every single millimetre to the highest technical and design standards and created a new kind of flashlight that is extremely powerful and extremely compact.

INDIVIDUALLY ADJUSTABLE





With the Piko flashlight you can choose between five pre-programmed lighting modes. Easily switch between 2-stage, 3-stage, 4-stage, ECO and RVLRL modes with the touch of a button. Other special functions such as SOS or the Alpine emergency signal are also available.







MINIMAX

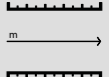

MAX

		
1600LM MAX. 100 LUX	16W MAX POWER	150G WEIGHT
		
87 x 42 x 24mm SIZE	1 - 47H RUNTIME (2.0AH BATTERY)	200m BEAM DISTANCE

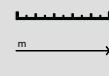
		
1600LM MAX. 100 LUX	16W MAX POWER	180G WEIGHT
		
103 x 42 x 24mm SIZE	1.5 - 80H RUNTIME (3.3AH BATTERY)	200m BEAM DISTANCE

BETTY TL 2

THE HANDHELD FLOODLIGHT

The Betty TL is your personal handheld floodlight. An easy-to-replace battery, a robust yet elegant aluminium case and a maximum output of 5400 lumens make Betty the perfect flashlight. A light yet robust aluminium case, a special lens arrangement for perfect illumination and enough output to illuminate entire valleys. The particularly powerful red light is perfect for not being immediately noticed when working in the dark. Our Betty flashlight is the absolute maximum technology can achieve.



BETTY TL 2

NO COMPROMISES

In order to produce the BTL, we first asked what makes a flashlight- a replaceable battery, robust and watertight housing, high-performance LEDs, an effective lens system and ease of use. With Betty TL, we wanted to get the best out of all the components. To do that, we redefined the limits of technology and created something special. A lamp without compromise.

FOR PHOTOGRAPHY AND FILM

The Betty TL is ideal for lighting in photography or film. With the 1/4 inch thread adaptor, you can mount the BTL on any commercially available photography tripod or even straight onto your camera using a flash slide adapter. Its 55 mm thread cap allows you to use a diffuser for softer light or common photo filters.

TRUST

Our Betty TL2 is official equipment used by the Norwegian police and proves itself regularly in rescue operations.

INDIVIDUALLY ADJUSTABLE

With the Betty torch, you have 11 different dimming levels and numerous additional functions at your disposal, including the red Centre LED, SOS, FLASH, RVLR and the Alpine emergency signal. With the single press of a button, you can switch between the levels, display the remaining battery life or combine up to 4 levels in any order and create your own personal lighting programme.



5400LM MAX.
320 LUX



45W MAX
POWER



57x195 mm
SIZE



1 - 160H RUNTIME
(6.9AH BATTERY)



425G
WEIGHT

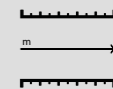

360m
BEAM DISTANCE

BTL 2 PRO

HIGH POWER LED FLASHLIGHT WITH CHARGING STATION

Far away from civilisation, you want a light that delivers what it promises: Waterproof, scratch-resistant and impact-resistant, 10.4 Ah battery tank and a gigantic 5400 lumens light output. The patented orbital charging technology and the docking station provides a charging current of 1.5 A to ensure the flashlight is always full.



BTL 2 PRO

UNCOMPROMISING OUTDOORS

When you're far away from civilisation, you want a light that delivers what it promises. Waterproof, scratch-resistant and impact-resistant, 10.4 Ah battery tank and a gigantic 5400 lumens light output. The BTL2 Pro is your uncompromising outdoor flashlight.

ALWAYS AND FULLY READY FOR ACTION

The unique orbital charging technology and the docking station ensure the flashlight is always fully charged. The BTL2 Pro is waiting in the charging station: just grab it and you'll instantly have 5400 lumens at your disposal for any use. Coloured LEDs display the current charge level and help you find your torch in the dark.





DOCKING STATION

The BTL2 Pro is the only lamp in the world with a charging station that you can use with a power supply unit, or with any source of voltage between 12 and 24V (direct current). The connection cable can be laid flexibly in all directions. The torch is held in the station by two low-wear spring systems which are reliable even under heavy loads, and can also be secured mechanically using a lever. The BTL2 Pro system is perfect for helicopters, ships and vehicles that are exposed to strong vibrations.

FLASHLIGHT EXTRA

The extra thick, hard-anodised surface (100 µm) and the shatterproof AF front glass protect the lamp head from knocks, impacts, dirt and water. The grooves on the outside of the extra-large battery tank ensure optimal handling and grip, even if you drop it in the mud.

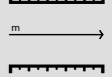

 5400 LUMENS 320 LUX	 45W MAX POWER
 57 x 274mm SIZE	 1.5 - 90H RUNTIME (10.4AH BATTERY)
 600G WEIGHT	 360m BEAM DISTANCE

OVERVIEW

LAMPSETS FLASHLIGHTS

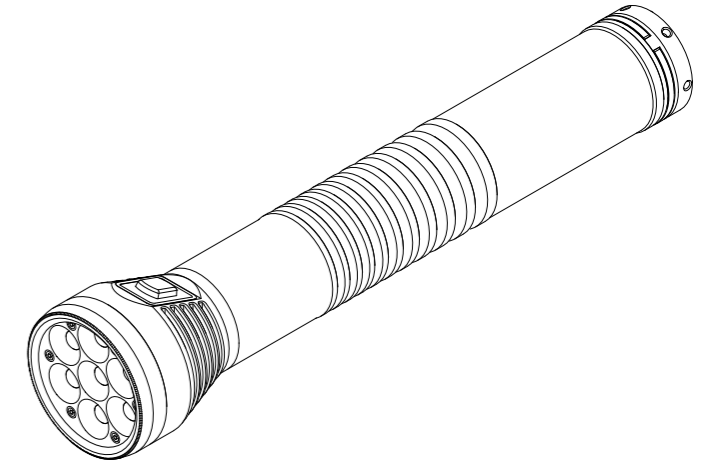
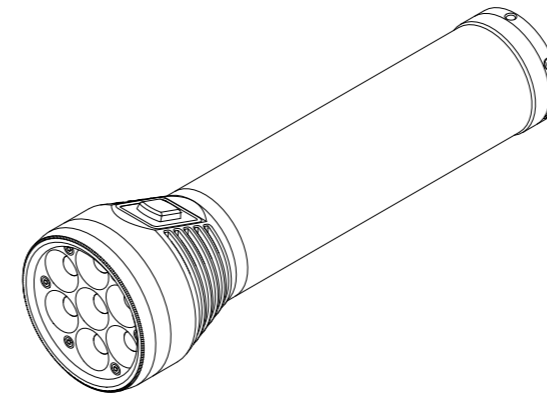
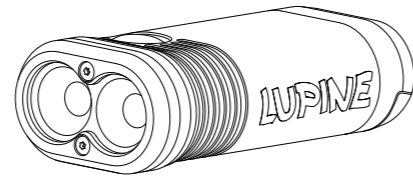

LIGHTTEST:



PIKO TL

BETTY TL 2

BTL 2 PRO

LIGHT OUTPUT
BATTERY
ACCESSORIES

SPECIAL FEATURE

LEDs
PROTECTION CLASS

1600 Lumens
2.0Ah, 3.3Ah
Toolfree mount, filter,
diffuser, holster
Extremely small and bright

Cree XM-L3
IP68 / K09

5400 Lumens
6.9Ah
1/4 inch tripod adapter,
diffuser, holster
Red Center LED

Cree XM-L3, XP-G
IP68 / K09

5400 Lumens
10.4Ah
Diffuser

Red Center LED,
Dockingstation
Cree XM-L3, XP-G
IP68 / K09

WE ARE THE LIGHT

LEGAL NOTICE

Lupine lighting systems GmbH
Im Zwiesel 9
92318 Neumarkt
GERMANY

Phone: +49 (0) 9181 509 49-0
E-Mail: info@lupine.de
www.lupine.de

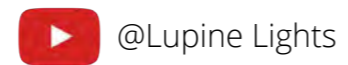
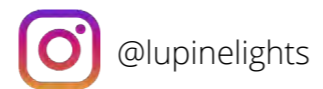

Rights for improvements and modifications of our products reserved.

