

# ASSEMBLY INSTRUCTIONS

---

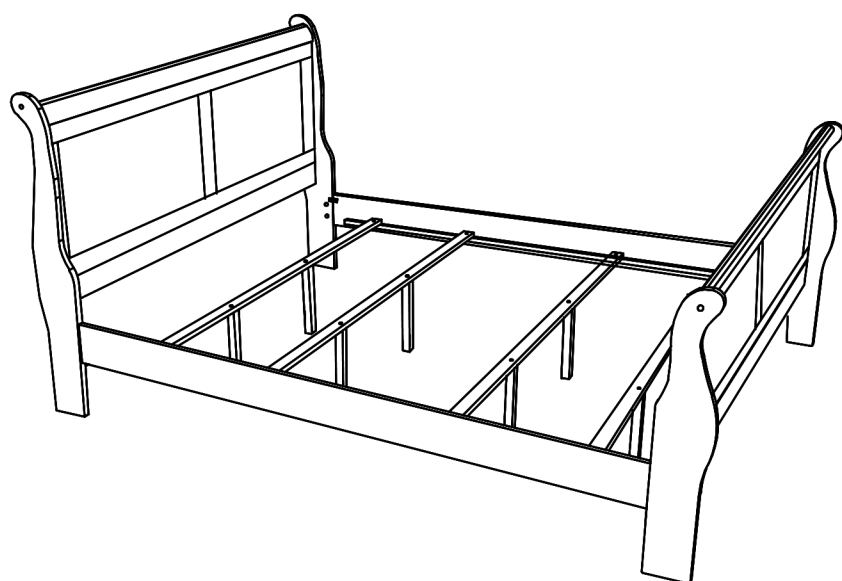

## TOOLS REQUIRED

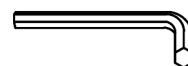

Allen Wrench

(Included)



Phillips Screwdriver

(Not Included)



**3- People Recommended**

## ASSEMBLY RATING



EASY → DIFFICULT

The Assembly Rating is a 5-point system showing the level of effort needed to assemble a specific product.



## **CHECK BEFORE STARTING**

### **Are you missing anything?**

Double-check all parts, hardware and accessories listed on Page 6 are accounted for.

### **Should we send any replacements?**

Are there any irregularities or flaws in the parts? We can send replacements!

### **Check out our Quick Tips!**

We recommend reviewing the pre-assembly handouts. Even experts need a refresher now and then!

### **Prep Time!**

Please review the assembly instructions and all diagrams prior to assembling. Arrange parts as recommended on Page 7 and group identical hardware together to make assembling easier.

# PRE ASSEMBLY INTRODUCTION

We understand building ready-to-assemble furniture can be a challenging experience for some. To help avoid confusion, we have provided some helpful tips that may speed up the process.

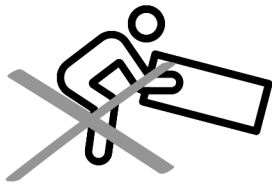

## Teamwork

ALWAYS have at least two people to help with transporting and assembling the product to avoid potential injury and/or damage.

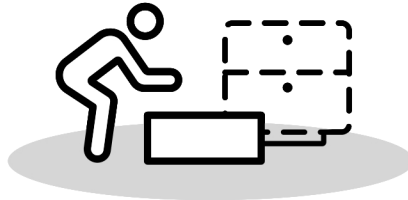
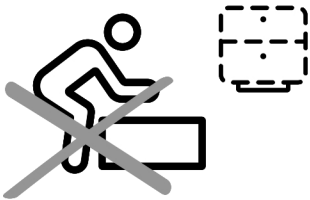

## Suitable Location

Assembling near the area of the intended location is highly recommended.



## Sufficient Space

Make sure you have enough space to move around during the assembly.

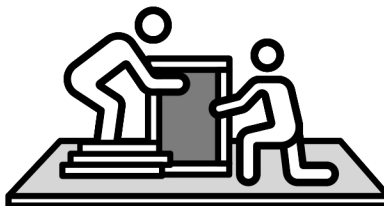

## Avoid Scratches

Use cardboard, blankets or a carpeted area while assembling furniture to prevent scratches.

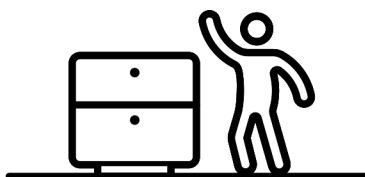
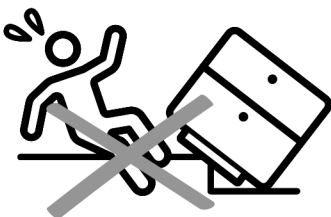

## Flat Surface

Make sure the furniture rests on a flat and level surface with each leg evenly touching the floor.

# ASSEMBLY AND CARE ADVICE



**FAILURE TO FOLLOW THE GUIDELINES BELOW MAY RESULT IN INJURY AND/OR PROPERTY DAMAGE.**



Position each part correctly and insert screws or bolts into their respective holes.

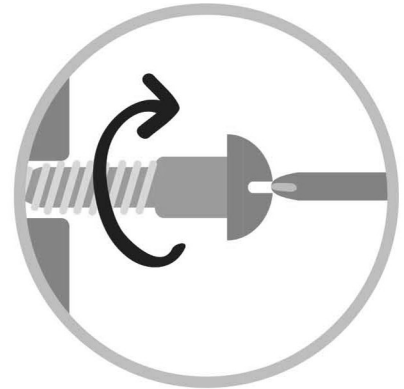

Turn clockwise to tighten and only tighten when step is completed or when instructed to do so.



Save the instructions and store any supplied tools for later maintenance.

Use the appropriate hand tools or power tools for assembly. Select steps, such as tightening screws and/or bolts, may require hand tools to avoid causing damage during assembly.



After two weeks, check and tighten any loose hardware and repeat again every six months thereafter.

**IT IS THE USER'S RESPONSIBILITY TO MAINTAIN THE FURNITURE. THE HARDWARE MAY LOOSEN OVER TIME AND MAY CAUSE THE FURNITURE TO BE WOBBLY AND UNABLE TO SUPPORT ITS INTENDED WEIGHT CAPACITY. THIS MAY LEAD TO COLLAPSE AND MAY CAUSE SERIOUS INJURY.**

# EASTERN KING BED



- Please keep instructions for future reference.
- Check the quantity and irregularity of parts and hardware before you start.

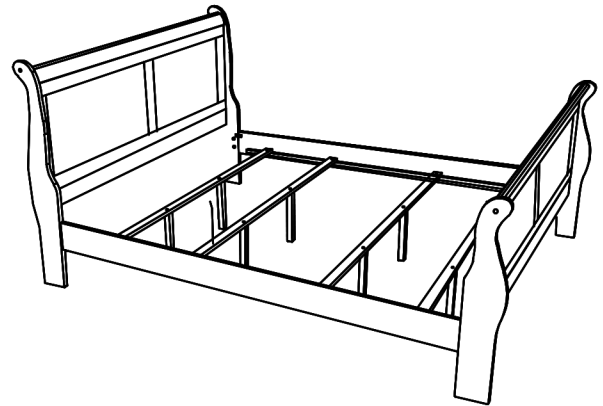

## PARTS

#1 1pc

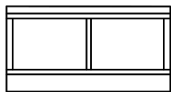

Headboard

#2 1pc

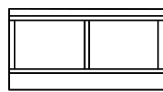

Footboard

#3 2pcs



Headboard Leg(L&R)

#4 2pcs



Footboard Leg(L&R)

#5 2pcs



Side Rail  
1948x140x18mm

#6 4pcs

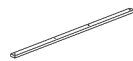

Bed Slat  
1951x45x18mm

#7 8pcs

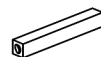

Bed Slat Support  
225x30x30mm

## HARDWARE

#A 4pcs



Wood Dowel  
M10x40mm

#B 4pcs

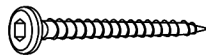

Bolt Wood Screw  
5/16" x 1 9/16"

#C 8pcs

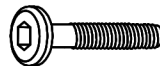

Bolt 1/4" x 1 3/8"

#D 8pcs



Lock Washer M6

#E 8pcs



Flat Washer M6

#F 1pc

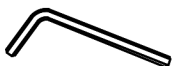

Allen Key m4

#G 4pcs



Wood Button

#H 8pcs

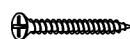

CSK M4 x 32mm

#I 16pcs

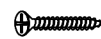





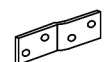



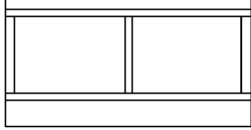

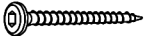



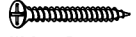

CSK M4 x 16mm

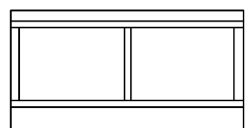
#J 4pcs



Bracket

| Carton | Designation               | Part   | Hardware  |
|--------|---------------------------|--|---|
|        | <b>E.King Size Bed HB</b> | #1         |  #A x 4pcs<br> #B x 4pcs<br> #C x 8pcs<br> #D x 8pcs<br> #E x 8pcs<br> #F x 1pc<br> #G x 4pcs<br> #H x 8pcs<br> #I x 16pcs<br> #J x 4pcs |
|        | <b>E.King Size Bed FB</b> | #2         |   |
|        | <b>Headboard Leg</b>      | #3  2pcs   |   |
|        | <b>Footboard Leg</b>      | #4  2pcs   |   |
|        | <b>Bed Slat</b>           | #6  4pcs  |   |
|        | <b>Bed Slat Support</b>   | #7  8pcs  |   |
|        | <b>Side Rail</b>          | #5  2pcs |   |

# ASSEMBLY INSTRUCTIONS

## 1

- Part #1 x1pc
- Part #3 x2pcs
- Hardware #A x2pcs
- Hardware #B x2pcs
- Hardware #C x4pcs
- Hardware #D x4pcs
- Hardware #E x4pcs
- Hardware #G x2pcs

1) Insert dowels (#A) to the headboard (#1).

2) Align HB legs (#3) to the headboard (#1), then secure by using bolts (#C) with washers (#D,E).

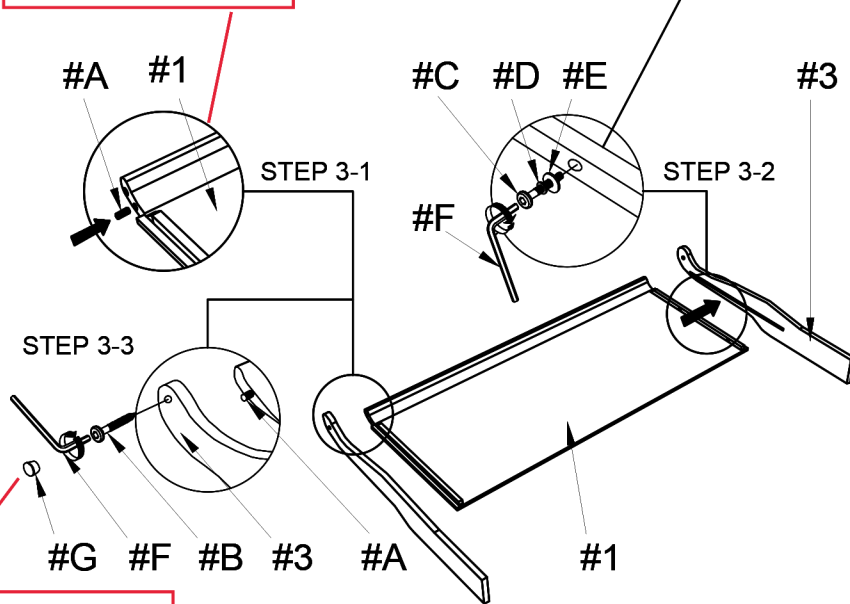

3) Secure HB legs (#3) onto headboard (#1) by using bolts (#B), then covering with caps (#G).

## 2

- Part #2 x1pc
- Part #4 x2pcs
- Hardware #A x2pcs
- Hardware #B x2pcs
- Hardware #C x4pcs
- Hardware #D x4pcs
- Hardware #E x4pcs
- Hardware #G x2pcs

Follow same step 1 as the headboard, but apply it to the footboard.

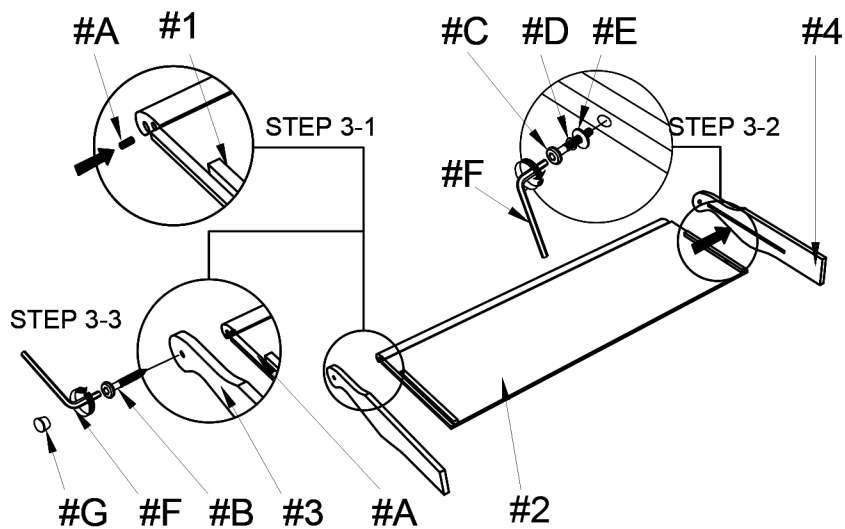

# ASSEMBLY INSTRUCTIONS

## 3

Part #5 x2pcs

Part #6 x4pcs

Part #7 x8pcs

Hardware #I x8pcs

Hardware #H x16pcs

Hardware #J x4pcs

2) Align brackets (#J) to the headboard and side rails, then secure by using screws (#I).

1) Align and hook the side rails (#5) to the headboard and footboard, then using a rubber mallet with cloth to apply pressure on the side rails (#5) to be fully secured.

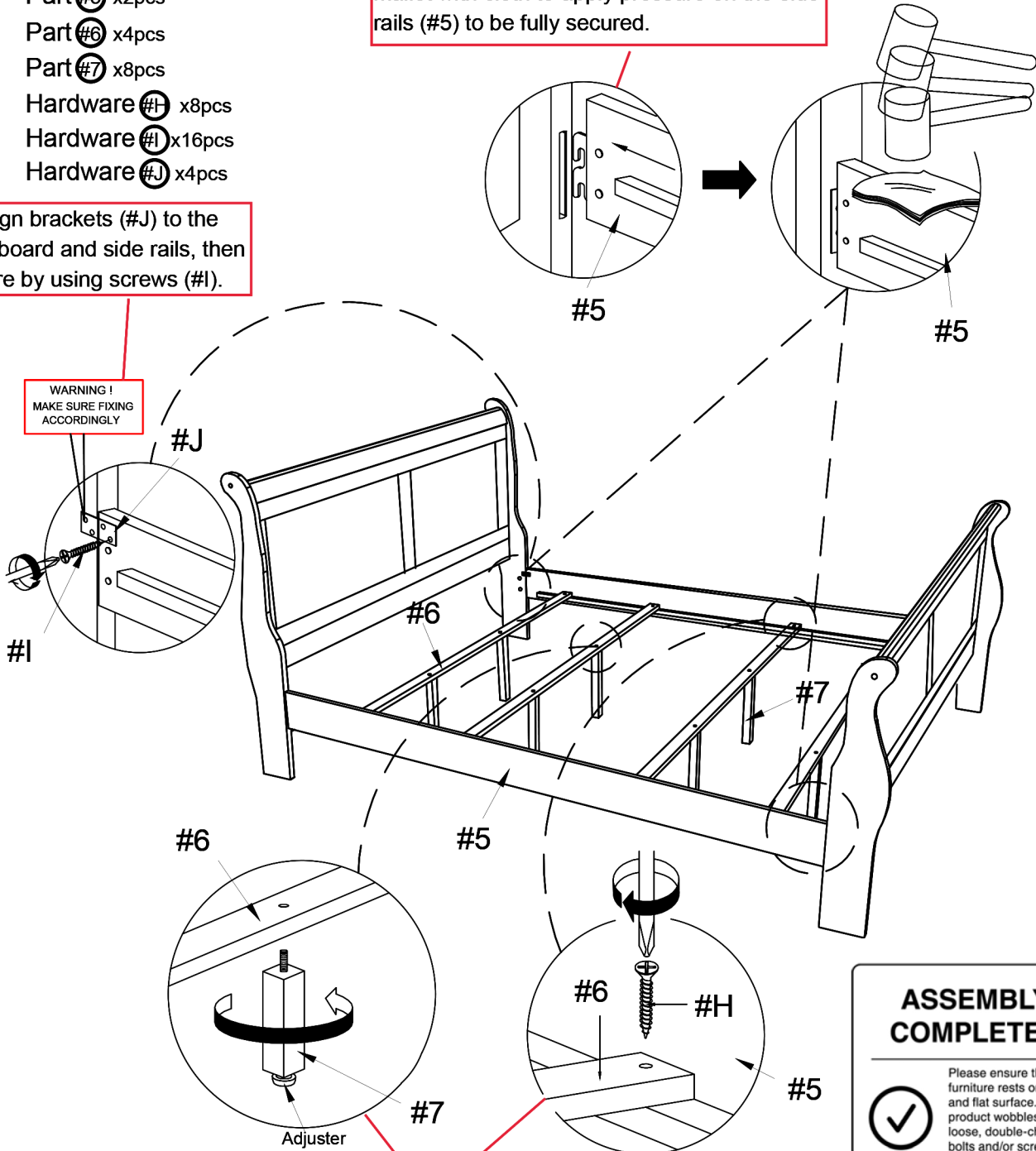

3) Attach support legs (#7) to the slats (#6), then align slats (#6) to the side rails (#5). Secure by using screws (#H).

**ASSEMBLY COMPLETED**

Please ensure the furniture rests on an even and flat surface. If the product wobbles or feels loose, double-check all bolts and/or screws are properly tightened and secured.

✓ **Keep this handy!**  
Please retain this instruction manual and any order-related information for future reference.

✓ **Lift, don't drag!**  
To avoid damage to product please always LIFT the product when transporting or adjusting the placement.