

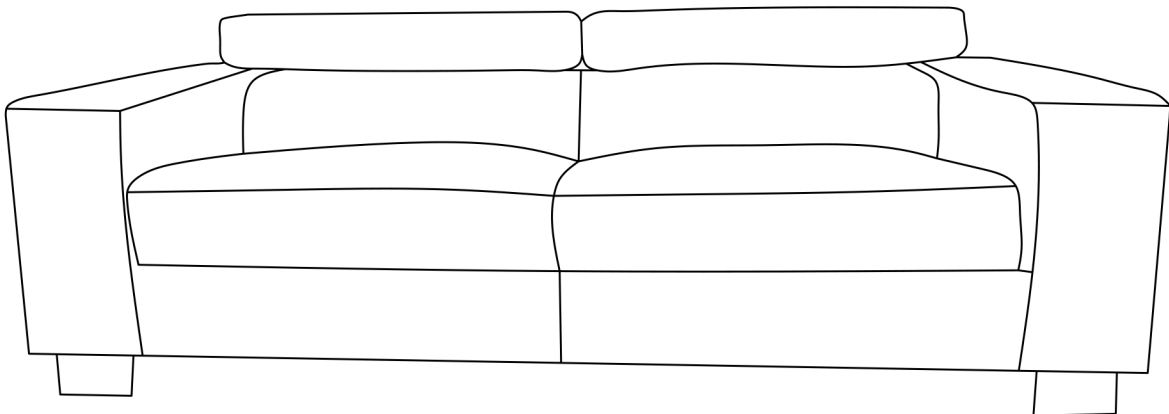

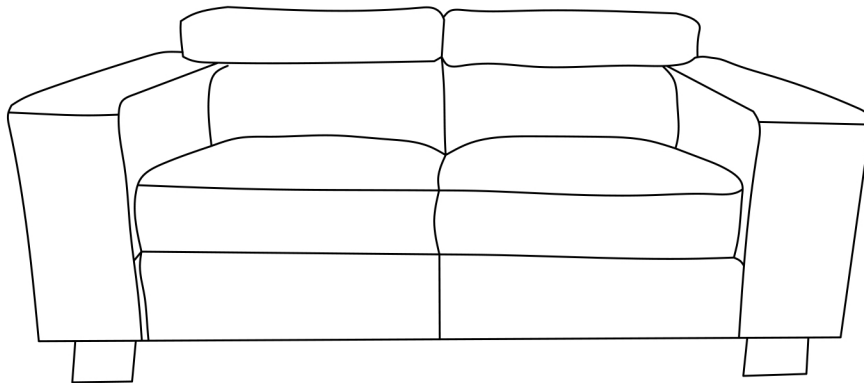

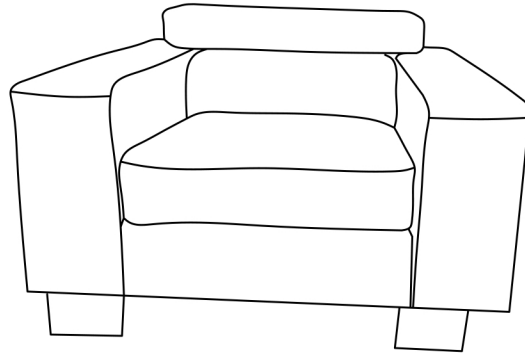

# Assembly Instructions

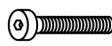

**Do not tighten screws until completely assembled.**

A		Feet	4PCS
B		Washers	4PCS
C		Allen Bolts	4PCS
D		Allen Key	1PCS
E		Wooden Screws	8PCS
F		Middle Leg	1PC

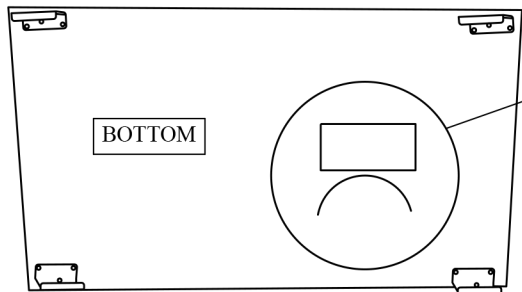

LEGS STORED IN ZIPPERED POUCH ON UNDERSIDE OF EACH PIECE!

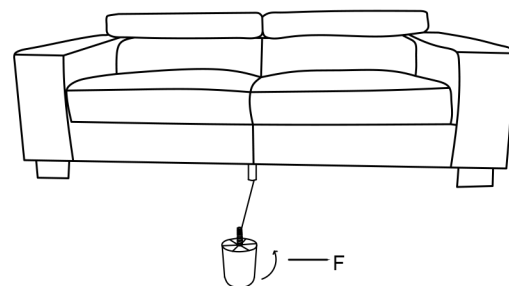
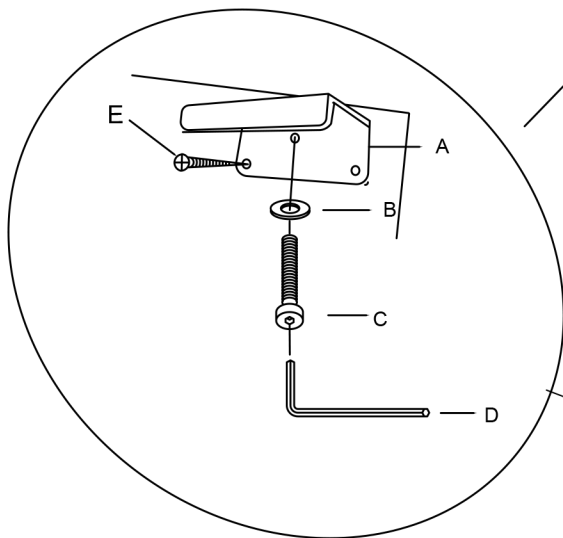
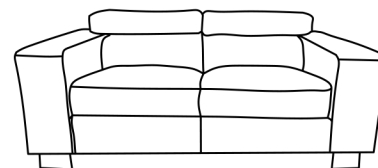
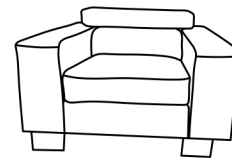

SCREW THE LEGS WITH WASHERS(B) AND ALLEN BOLTS(C) FIRST, THEN SCREW THE WOODEN SCREWS(E) INTO THREADED RECEPTACLES AT THE TWO SIDES OF THE LEG.

**Do not tighten screws until completely assembled.**

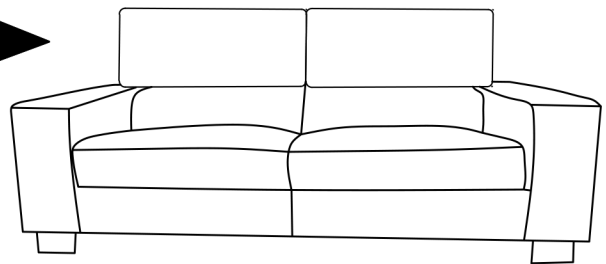
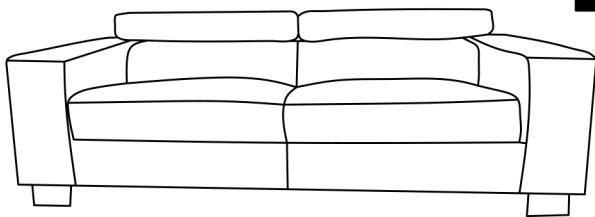
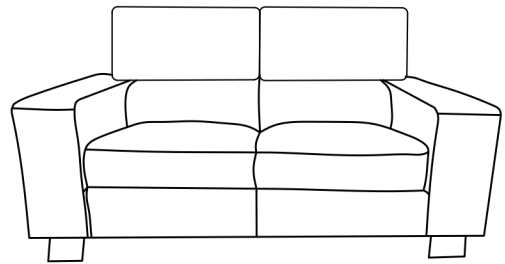
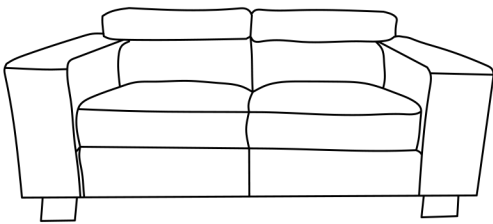
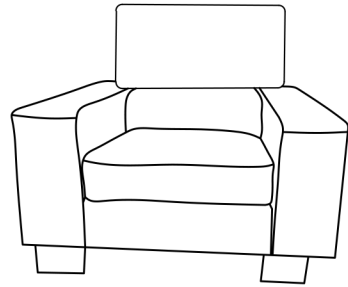
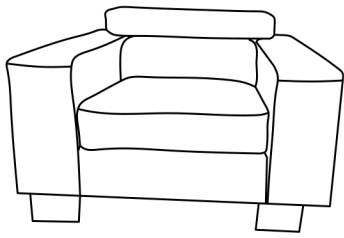

**THE HEADREST CAN BE LIFT UP AND LAY DOWN!**

**Do not tighten screws until completely assembled.**