

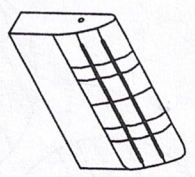

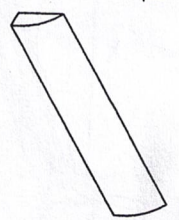

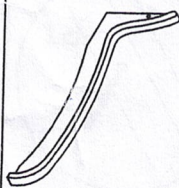





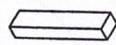
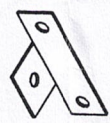

Vasco PB 1442

<p>Ax1</p> 	<p>Bx1</p> 
<p>Cx2</p> 	<p>Dx1</p> 
<p>Ex2</p> 	<p>Fx2</p>  <p>13.5cm</p>
<p>Gx2</p> 	<p>Hx4</p> 
<p>Ix4</p>  <p>4cm</p>	<p>Jx1</p>  <p>Kx4</p>  <p>(5*50)</p>
<p>Lx22</p>  <p>(8*20)</p>	<p>Mx10</p>  <p>Nx24</p>  <p>(3.5*30)</p>
<p>Ox12</p> 	<p>Px2</p>  <p>Qx2</p>  <p>6cm</p>



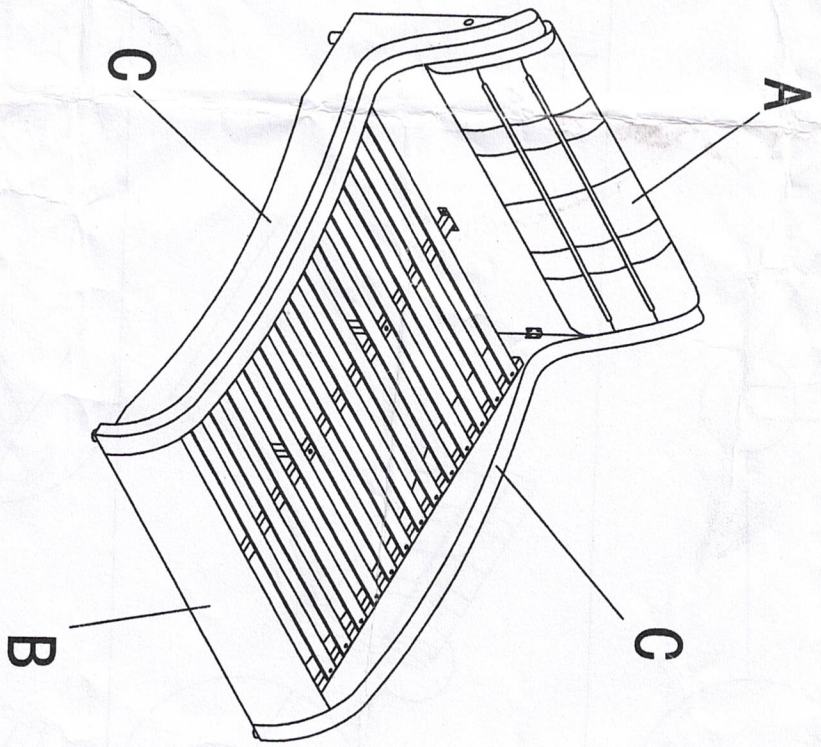
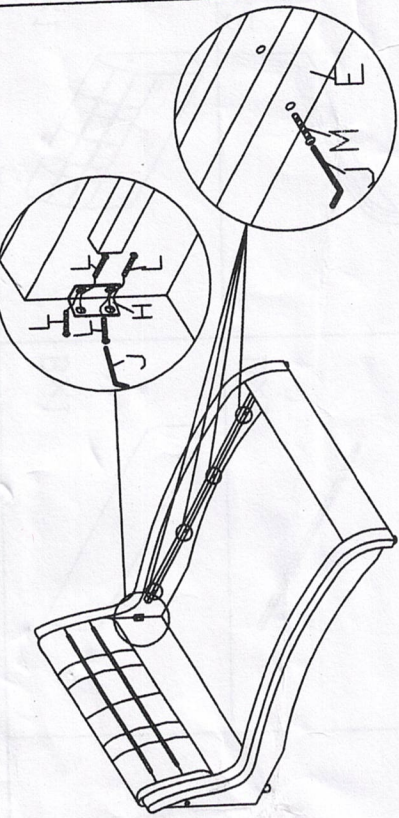

2

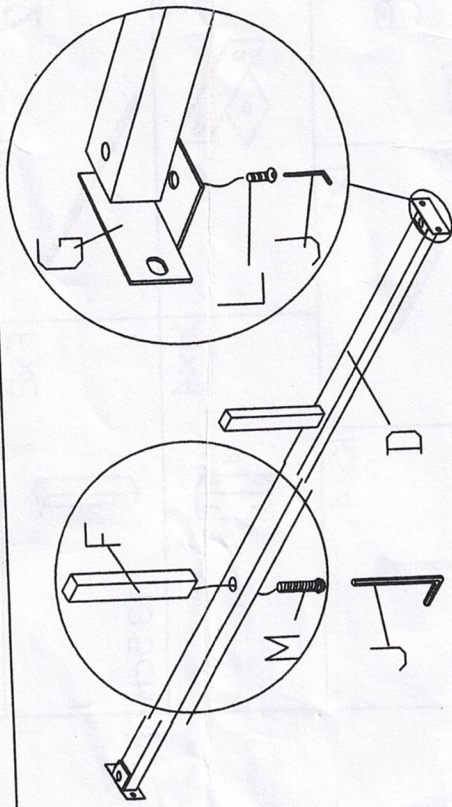

4

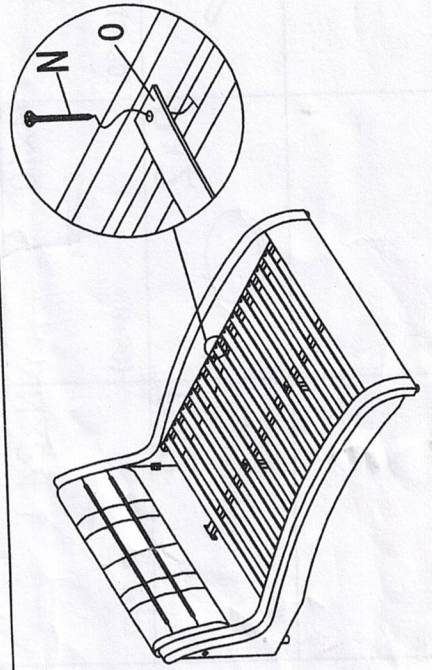

6

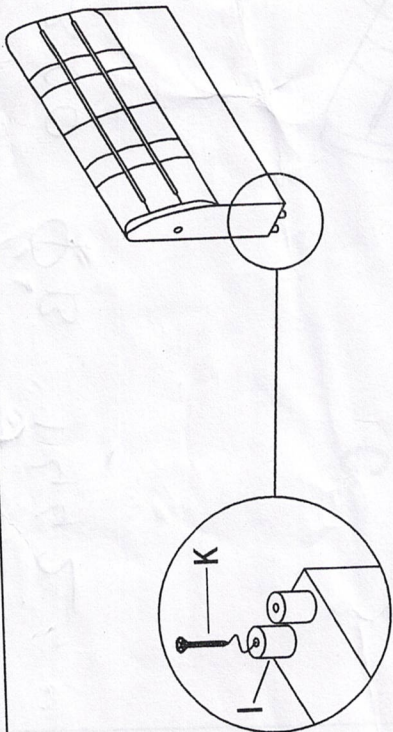

1

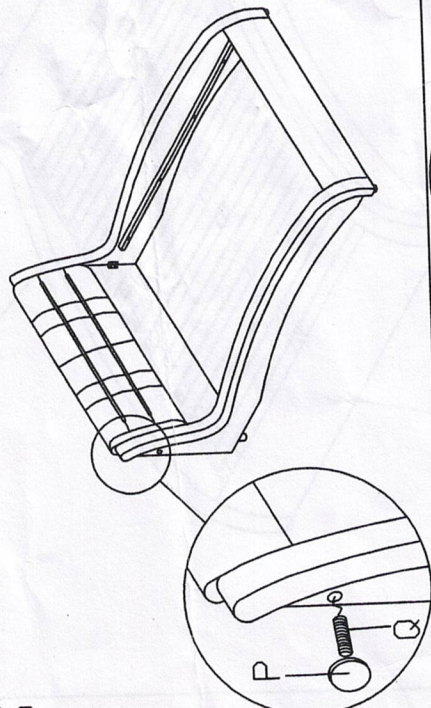

3

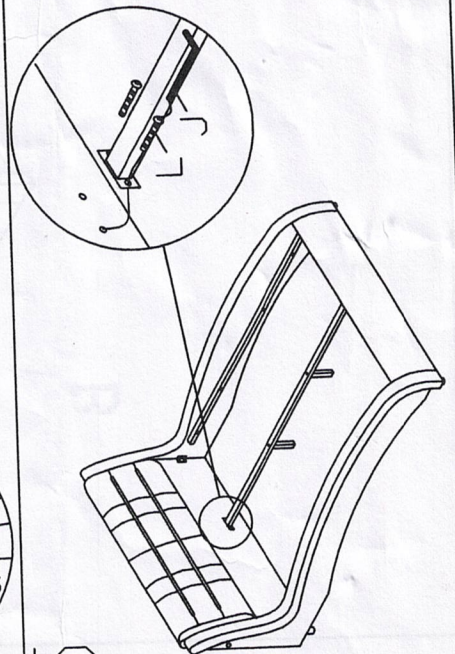

5