



# ASSEMBLY INSTRUCTIONS

## QUEEN BED - ELDO2

### HARDWARE FOR WOODEN

No.	Hardware	Q.ty
①	Bolts M5x10 	08
②	Key K5 	01
③	Vis M4x30 	06

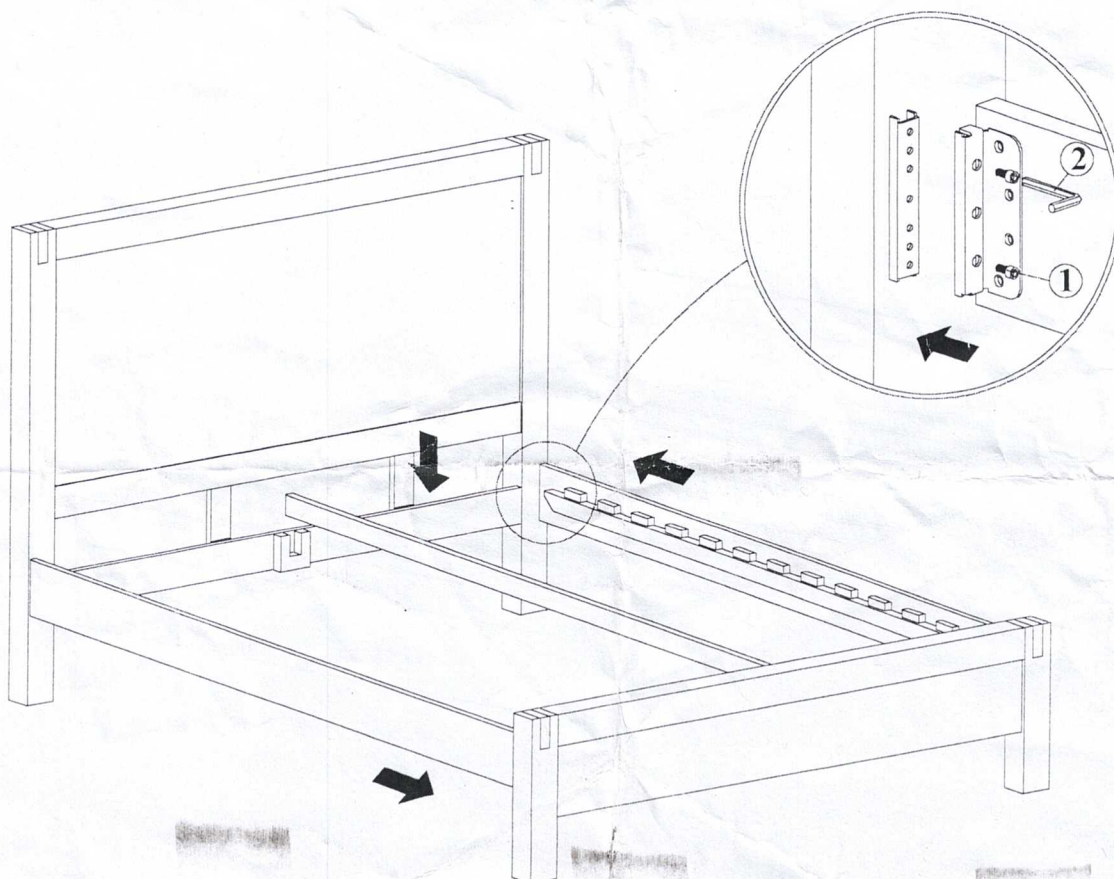
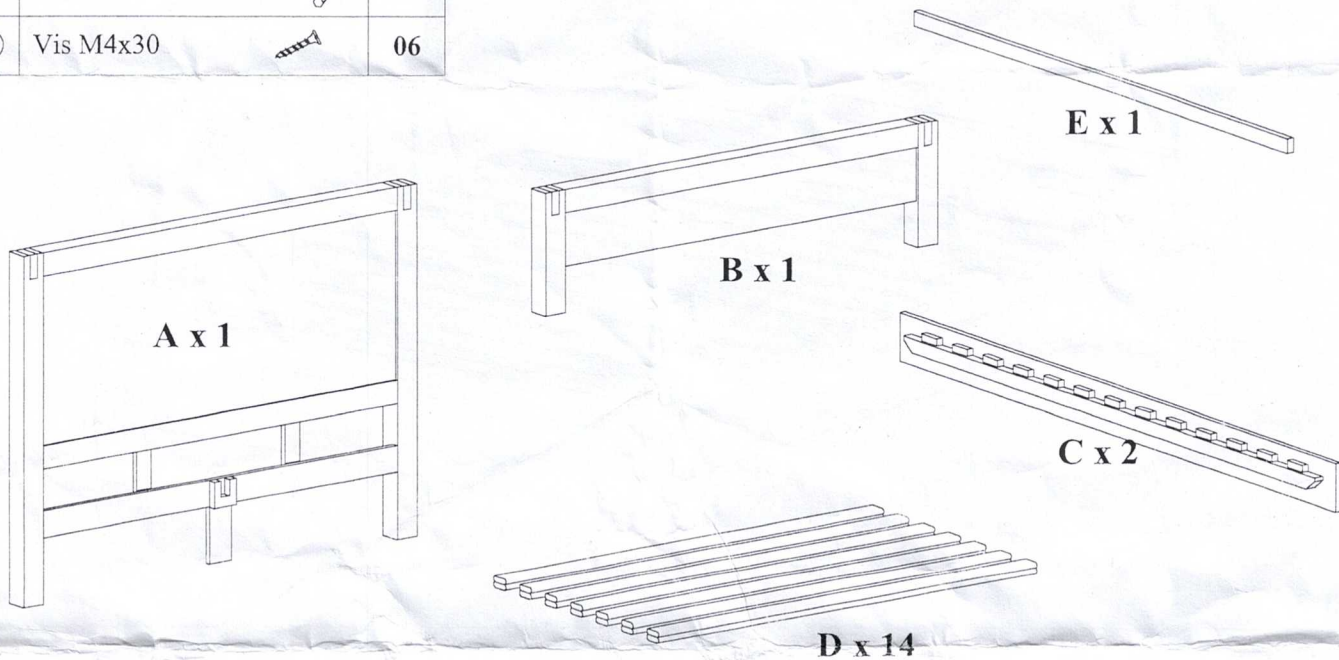
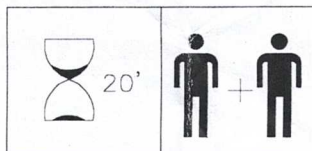

# ASSEMBLY INSTRUCTIONS

## QUEEN BED - ELDO2

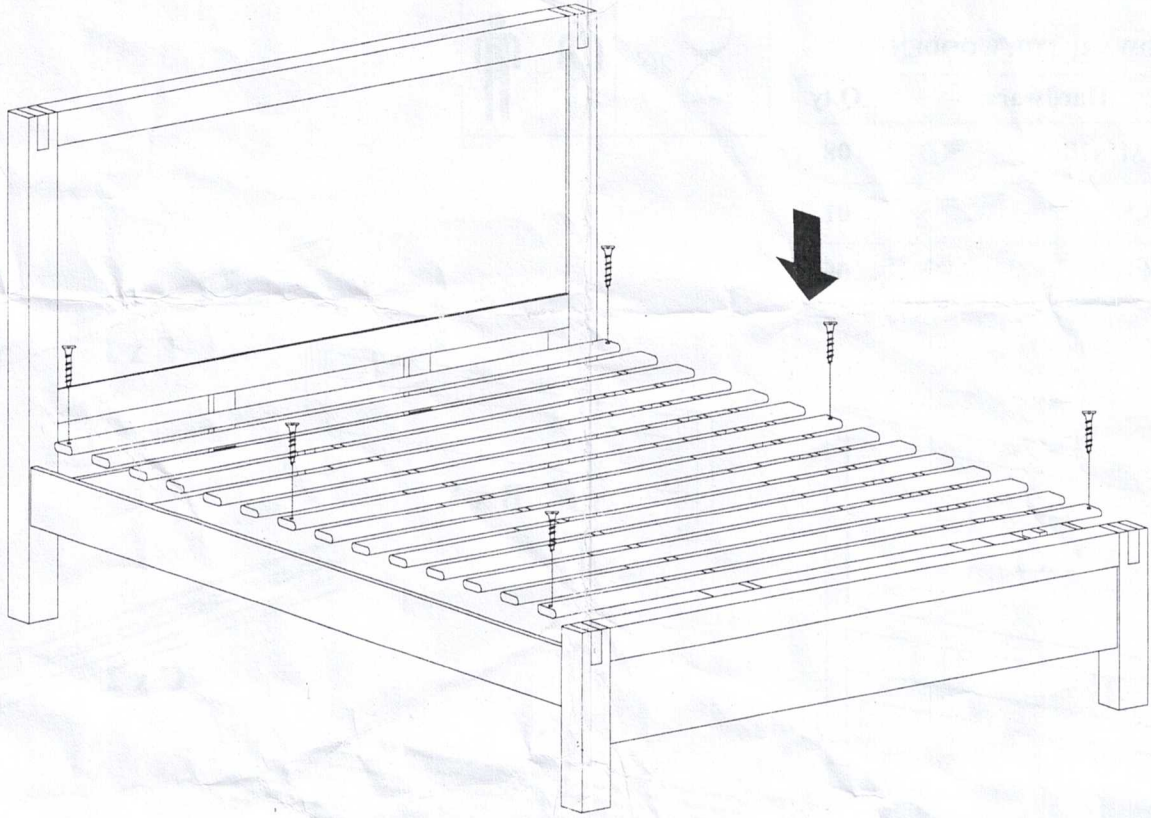

**STEP 2**

