

# REXGEAR

*Your Power Solution Expert*

---

## User Manual

**BCS Series 24-channel Dual-quadrant  
Battery Simulator**

REXGEAR INC.

Version: V20231221

## Contents

1 PREFACE .....	1
2 SAFETY INSTRUCTIONS .....	2
2.1 Safety Symbols.....	2
2.2 Safety Precautions .....	2
3 INSPECTION & INSTALLATION .....	3
3.1 Inspection .....	3
3.2 Connection to Power Cord.....	3
3.3 Precaution .....	4
WHEN THE DEVICE CANNOT START NORMALLY, PLEASE TRY THE FOLLOWING SOLUTIONS .....	4
1. CHECK WHETHER THE POWER CORD IS CONNECTED PROPERLY, WHETHER THE DEVICE HAS BEEN POWERED NORMALLY, AND WHETHER THE EQUIPMENT SWITCH IS TURNED ON;.....	4
2. CHECK WHETHER THE FUSE IS BLOWN, IF THE IT IS, THEN PLEASE REPLACE IT WITH THE SAME SPECIFICATION TYPE FUSE TO AVOID CAUSING ACCIDENTS .....	4
250V/16A/20×5/CERAMIC.....	4
3.4 Wiring.....	5
3.4.1 Regular Wiring.....	5
3.4.2 Optional Wiring .....	5
3.4.3 BMS Wiring.....	6
3.5 Remote Sense.....	6
4 PRODUCT.....	8
4.1 Brief Introduction .....	8
4.2 Dimension .....	9
4.3 Optional Accessory Installation(NB108-2) .....	12
4.4 Front Panel Introduction.....	14
4.4.1 Button & Knob .....	14
4.4.2 Function Button.....	15
4.4.3 Numeric Button .....	16
4.4.4 Knob .....	16
4.5 Rear Panel Introduction.....	17
4.5.1 Regular .....	17
4.5.2 Optional.....	18
4.5.3 Channel Interface (Regular).....	18
4.5.4 Channel Interface (Optional) .....	19
4.5.5 RS232 Interface .....	20
4.5.6 LAN Port .....	21

4.5.7 CAN Interface .....	22
4.5.8 Default Communication Parameter .....	23
5 OPERATION .....	23
5.1 Interface .....	24
5.2 Source Mode .....	25
5.2.1 Parameter Setting .....	26
5.2.2 Operation Example .....	27
5.3 Charge .....	28
5.3.1 Parameter Setting .....	29
5.3.2 Operation Example .....	30
5.4 Battery .....	31
5.4.1 Parameter Setting .....	32
5.4.2 Operation Example .....	34
5.5 SOC Edit .....	35
5.5.1 Parameter Setting .....	36
5.5.2 Operation Example .....	38
5.6 SOC Test .....	39
5.6.1 Parameter Setting .....	40
5.6.2 Operation Example .....	41
5.7 SEQ Edit .....	42
5.7.1 Parameter Setting .....	43
5.7.2 Operation Example .....	45
5.8 SEQ Test .....	46
5.8.1 Parameter Setting .....	46
5.8.2 Operation Example .....	46
5.9 Graph .....	48
5.10 CAN Set .....	49
5.11 All View .....	50
5.12 System .....	51
5.13 Protection .....	53
5.14 Fault Simulation (Optional) .....	54
5.15 About Us .....	55
6 MAINTENANCE AND SELF-INSPECTION .....	56
6.1 Regular Maintenance .....	56
6.2 Fault Self-inspection .....	56
7 MAIN TECHNICAL DATA .....	57

# 1 Preface

## Dear Customers

First of all, we greatly appreciate your choice of BCS series Multi-channel Dual-quadrant Battery Simulator (BCS for short).

## About User Manual

This manual is applied to BCS series battery simulator, including installation, operation, specifications and other detailed information. Due to the upgrade of instrument, this manual may be revised without notice in future versions.

This manual has been reviewed carefully by REXGEAR for the technical accuracy. The manufacturer declines all responsibility for possible errors in this operation manual, if due to misprints or errors in copying. The manufacturer is not liable for malfunctioning if the product has not correctly been operated.

To ensure the safety and correct use of BCS, please read this manual carefully, especially the safety instructions.

Please keep this manual for future use.

## 2 Safety Instructions















In the operation and maintenance of the instrument, please strictly comply with the following safety instructions. Any performance regardless of attentions or specific warnings in other chapters of the manual may impair the protective functions provided by the instrument.

REXGEAR shall not be liable for the results caused by the neglect of those instructions.

### 2.1 Safety Symbols

Please refer to the following table for definitions of international symbols used on the instrument or in the user manual.

Table 1

Symbol	Definition	Symbol	Definition
	DC (direct current)	N	Null line or neutral line
	AC (alternating current)	L	Live line
	AC and DC	I	Power-on
	Three-phase current		Power-off
	Ground		Back-up power
	Protective ground		Power-on state
	Chassis ground		Power-off state
	Signal ground		Risk of electric shock
WARNING	Hazardous sign		High temperature warning
Caution	Be careful		Warning

### 2.2 Safety Precautions

- **Confirm the AC input voltage before supplying power.**
- **Reliable grounding:** Before operation, the instrument must be reliably grounded to avoid the electric shock.
- **Confirm the fuse:** Ensure to have installed the fuse correctly.
- **Do not open the chassis:** The operator cannot open the instrument chassis. Non-professional operators are not allowed to maintain or adjust it.
- **Do not operate under hazardous conditions:** Do not operate the instrument under flammable or explosive conditions.
- **Confirm the working range:** Make sure the DUT is within BCS's rated range.

## 3 Inspection & Installation

### 3.1 Inspection

After receiving BCS, please check the instrument according to the following steps:

1. Check whether the instrument is damaged during transportation. If any severe damage to the package, please contact our authorized distributor or REXGEAR.
2. Check accessories.
3. Check the whole instrument. If BCS chassis is damaged or has abnormal operation, please contact our authorized distributor or REXGEAR.

### 3.2 Connection to Power Cord

Before connecting the power cord, observe the following precautions to prevent electric shock and damage to the instrument:

#### **Warnings**

- Make sure that the voltage matches the rated voltage of the instrument;
- Make sure the power switch is off;
- Please use the power cord supplied by our company, and connect the power cord to a three-pronged socket with a protective grounding terminal;

Connect one end of the power cord to the input socket on the back panel of the instrument and the other end to the three-pronged socket with a protective grounding terminal.

## 3.3 Precaution

---

### **Warnings**

1. Before connecting the power cord, please make sure that the power supply voltage matches the rated power supply voltage of this instrument.
  2. To prevent electric shock and fire, use the power cord supplied by us.
  3. To prevent electric shock, be sure to take protective grounding. Connect the power cord to a three-pronged socket with a protective earth terminal.
- 

When the device cannot start normally, please try the following solutions:

1. Check whether the power cord is connected properly, whether the device has been powered normally, and whether the equipment switch is turned on;
2. Check whether the fuse is blown, if the it is, then please replace it with the same specification type fuse to avoid causing accidents.

Table 2

Model	BCS Series
Specification	250V/16A/20×5/Ceramic

#### **The fuse replacement can be performed as follows:**

1. Turn off the instrument and remove the power cord.
2. Insert a small screwdriver into the groove at the power socket and gently pry out the fuse holder.
3. Remove the fuse and replace it with one of the specified size.

---

### **Warnings**

To ensure operator safety, disconnect power to the instrument before replacing the fuse.

---

## 3.4 Wiring

### 3.4.1 Regular Wiring

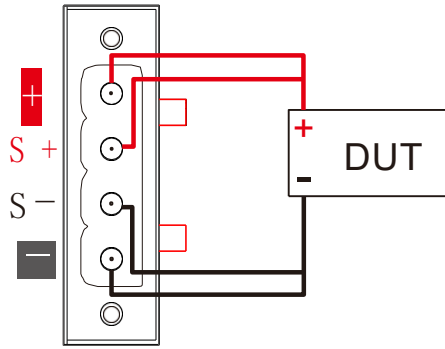

Figure 1 Regular wiring

### 3.4.2 Optional Wiring

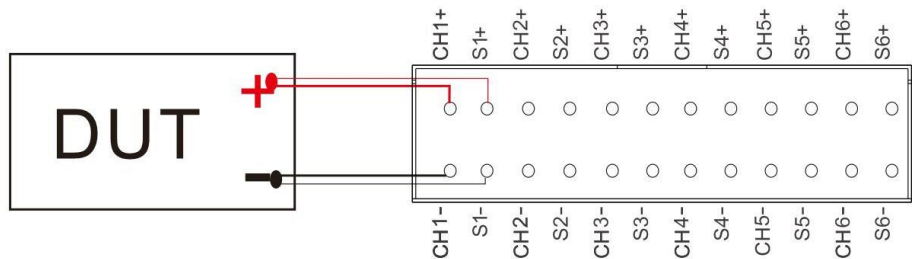

Figure 2 Optional wiring



### 3.4.3 BMS Wiring

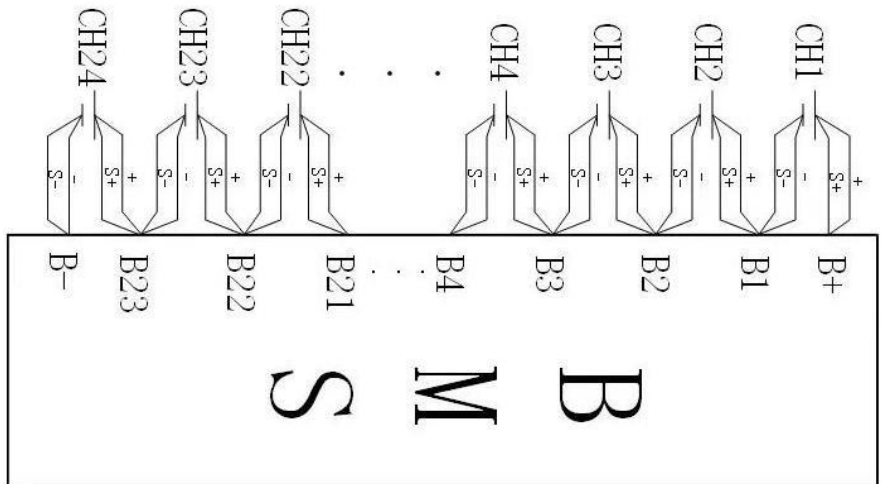

Figure 3 BMS wiring

### 3.5 Remote Sense

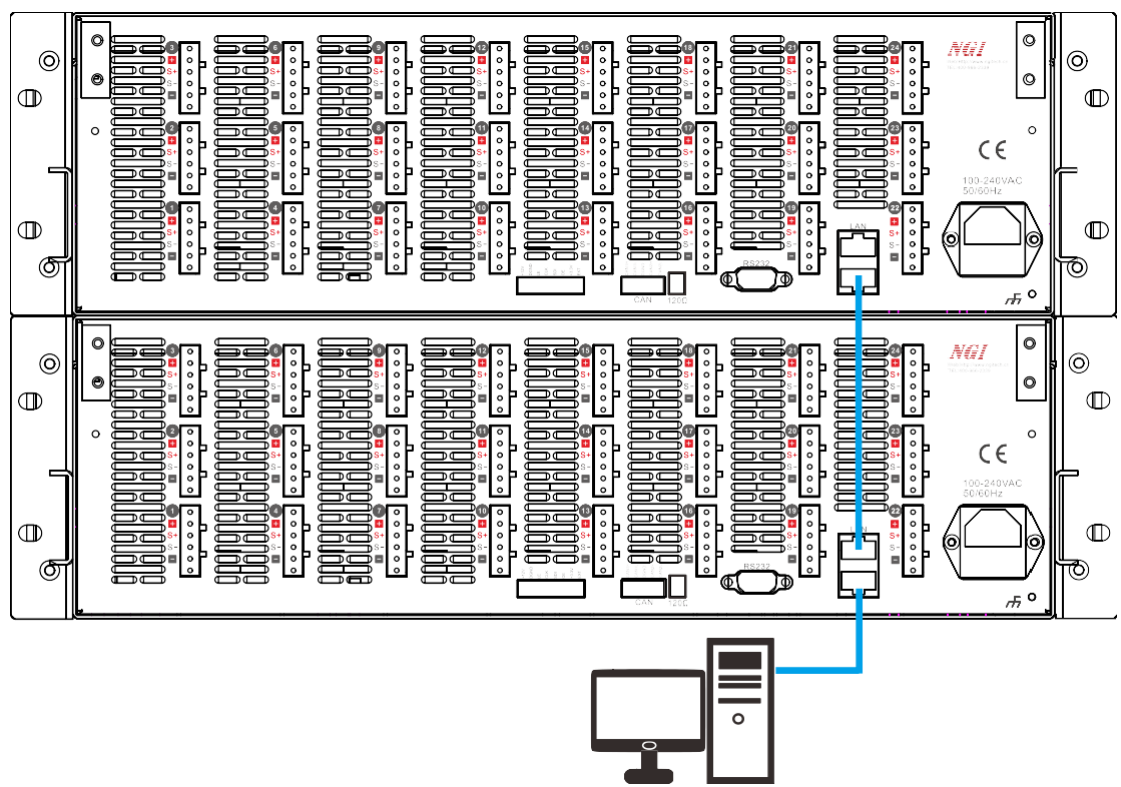

Figure 4 Remote Sense

The BCS can be connected to a computer via a network cable. Before powering

on the computer, make sure that the wires are correctly connected and that the communication settings are correct. The BCS series battery simulator can also be controlled by multiple units at the same time.

For LAN communication, users need to connect the LAN to the computer through a network cable and a switch. Before powering on the computer, check if the connection is correct and make sure that the IP addresses of all BCSs are not duplicated. BCS series power supply adopts UDP network communication mode, users can set the IP address, the default port number is 7000 and the default ID is 0. Using RS232 communication mode, baud rate needs to be set. The baud rate can be set to 9600, 19200, 38400, 57600 and 115200.

As is shown on the following figure:



Figure 5 Remote Sense

## 4 Product

### 4.1 Brief Introduction

BCS is a programmable battery simulator with low-power, multi-channel and high-accuracy. By adopting dual-quadrant design, the current can be charged and discharged, which can satisfy the needs of BMS test and consumer electronics ATE test. Its voltage accuracy is up to 0.6mV, supporting  $\mu\text{A}$ -level current measurement, standalone up to 24 channels. The channels are isolated from each other, which is convenient for series connection. BCS supports both local operation and remote operation via LAN/RS232/CAN interface. BCS application software is easy to use, which can meet demands of battery simulators in multi-channel, multiparameter, and complex test environments.

#### Features

- Voltage range: 0~6V
- Current range:  $\pm 1\text{A}/\pm 3\text{A}/\pm 5\text{A}$
- Voltage accuracy up to 0.6mV
- $\mu\text{A}$ -level current measurement
- Voltage ripple noise  $\leq 2\text{mVrms}$
- High integration, standalone up to 24 channels, each channel isolated
- $\mu\text{s}$ -level dynamic response, simulating the characteristics of real battery
- Optional NB108 series products to achieve fault simulation and nA-level current measurement
- Supporting charge mode, battery simulation, SEQ test, SOC test
- 4.3 inch high-definition color LCD screen, local/remote control, standard application software
- LAN port, RS232 interface, CAN interface; dual LAN ports, convenient for

cascade application

## 4.2 Dimension

### 4.2.1 Regular Dimension

BCS Series dimension: 132.5mm(H)\*482.0mm(W)\*559.0mm(D)

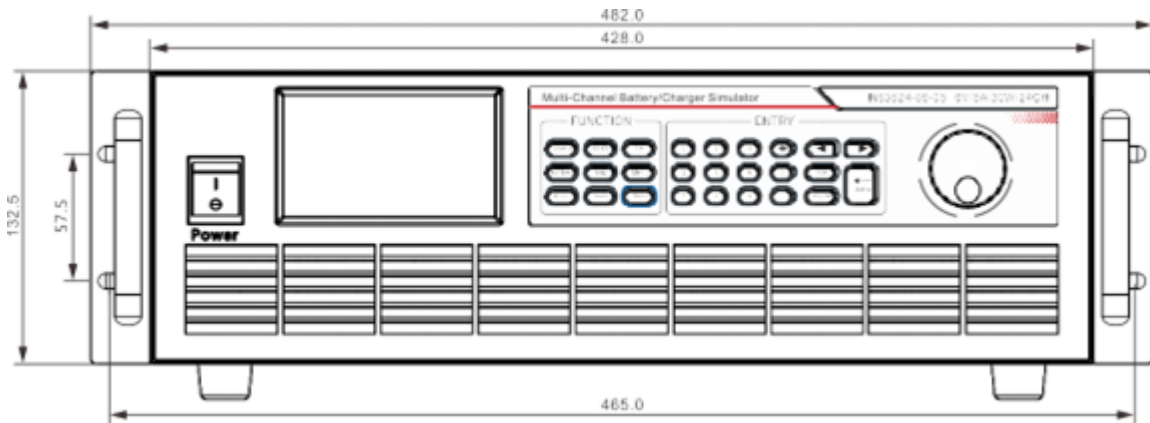

Figure 6 Front Panel Dimension(mm)

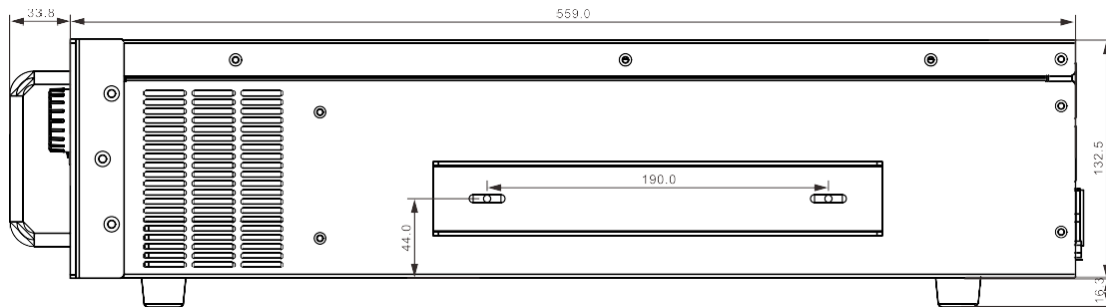

Figure 7 Side Dimension(mm)

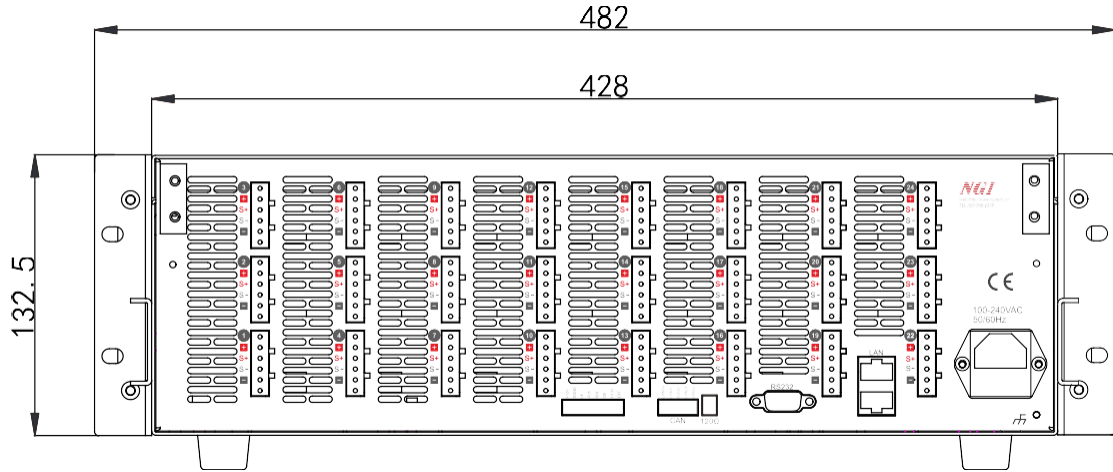

Figure 8 Rear Panel Dimension(mm)

### 4.2.2 Optional Dimension

BCS+NB108-2 Series Dimension:  
132.5mm(H)\*482.0mm(W)559.0mm(D)+166.9mm(D)

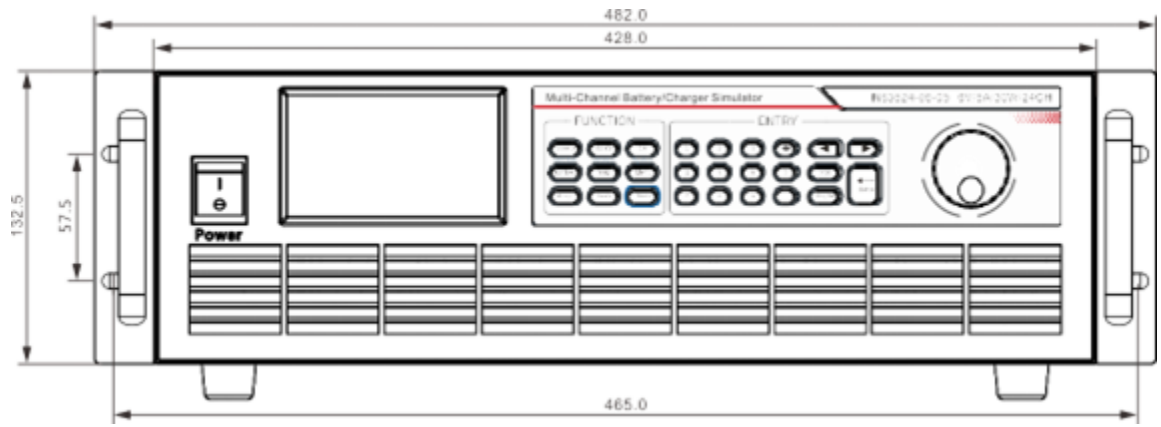

Figure 9 Front Panel Dimension(mm)

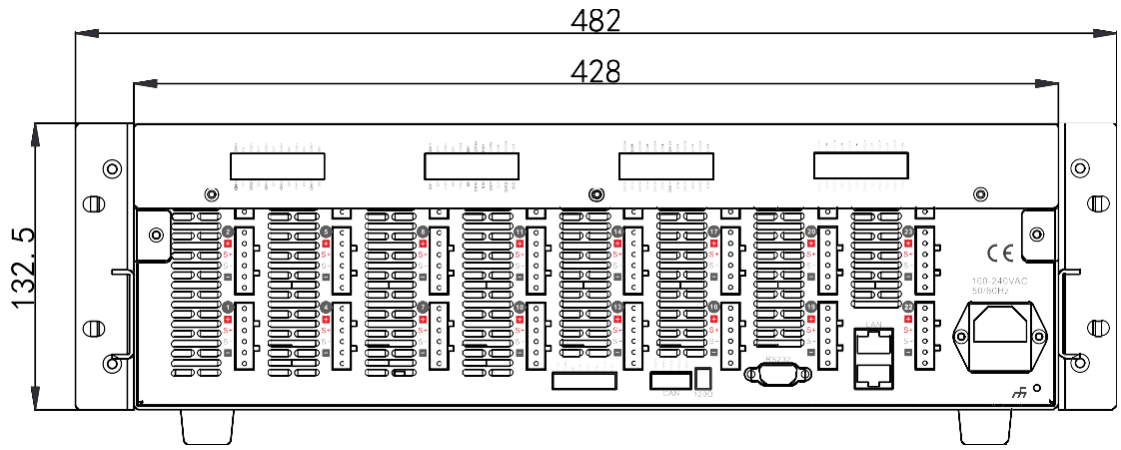

Figure 10 Rear Panel Dimension(mm)

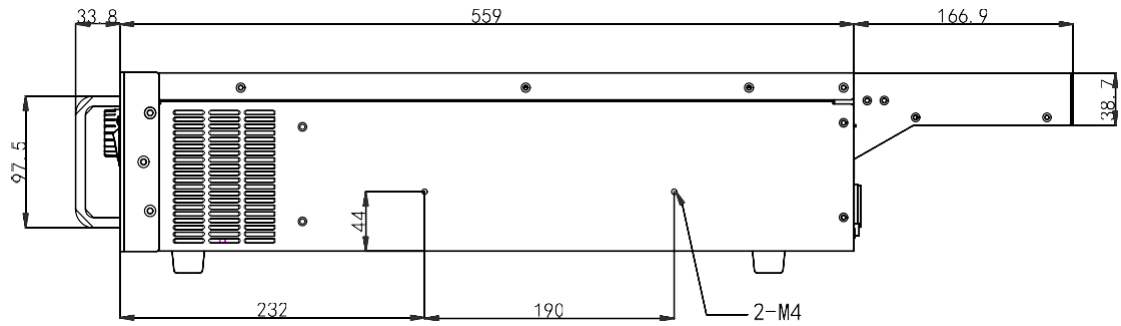

Figure 11 Side Dimension(mm)

**4.2.2.1 NB108-2 Dimension**

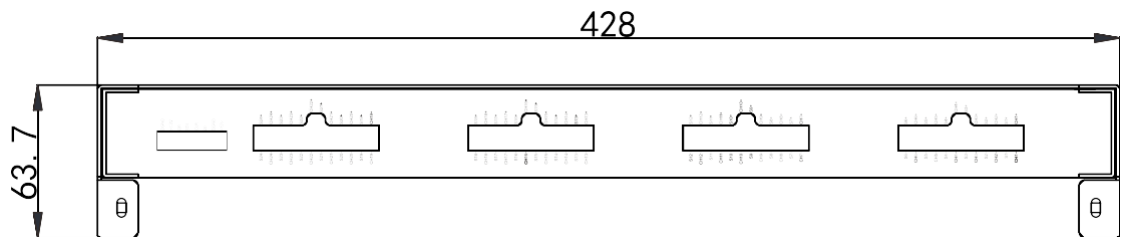

Figure 12 Front Panel Dimension(mm)

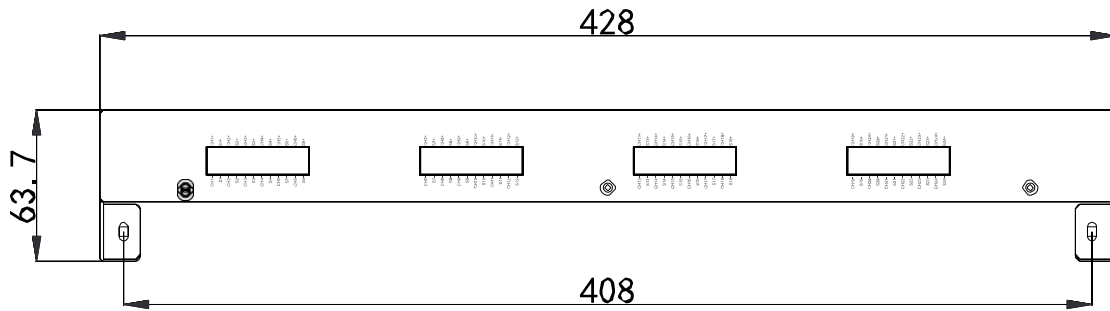

Figure 13 Rear Panel Dimension(mm)

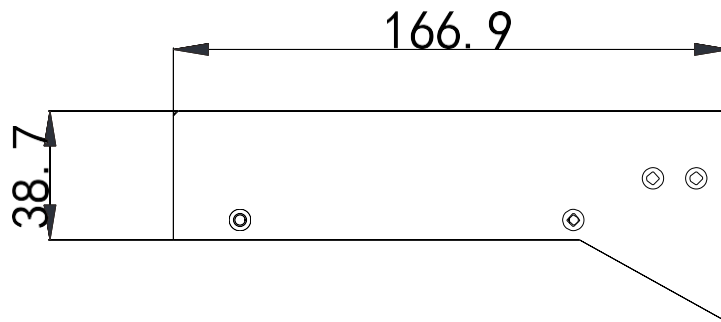

Figure 14 Side Dimension(mm)

### 4.3 Optional Accessory Installation(NB108-2)

The installation method of optional accessory can be carried out according to the following steps.

1. Turn off the AC input power and remove the power cord.
2. Take out the screws, and use a screwdriver to fix the bracket to the holes on the rear panel of BCS.



Figure 15 Bracket Installation

3. Connect NB108-2 power control cable to BCS power control terminal.
4. Connect NB108-2 channel harness to the channel interface of BCS, taking CH1 as an example.

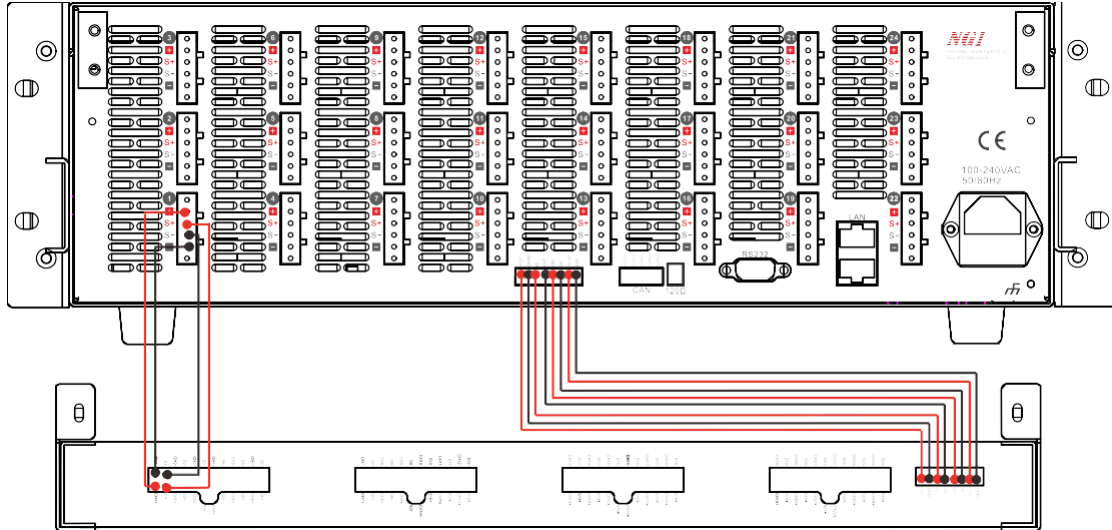

Figure 16 Wiring Harness Connection

5. Fix NB108-2 to the bracket and the hole bar on rear panel of BCS with screws.

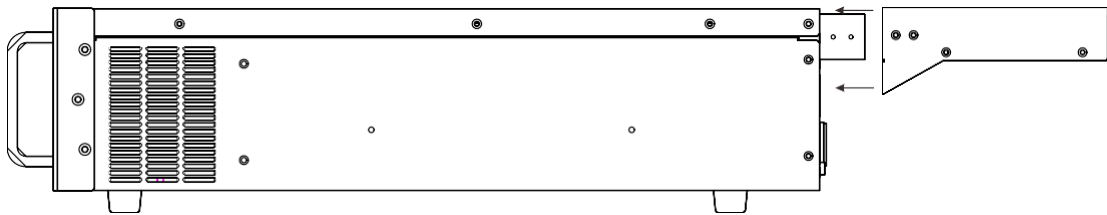

Figure 17 Fixing NB108-2

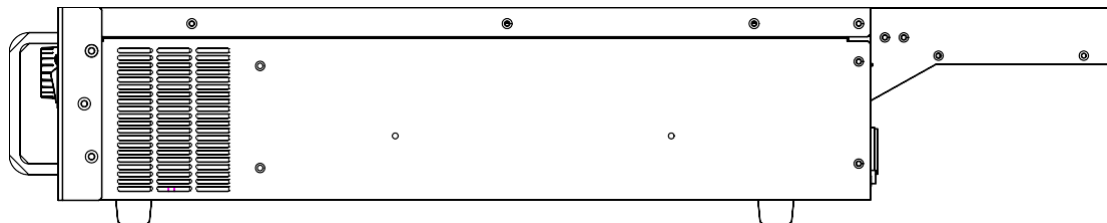

Figure 18 Installation Completed

---

## **Warnings**

**To ensure the safety of the operator, please disconnect the input power of the instrument before installing the accessory.**

---



## 4.4 Front Panel Introduction

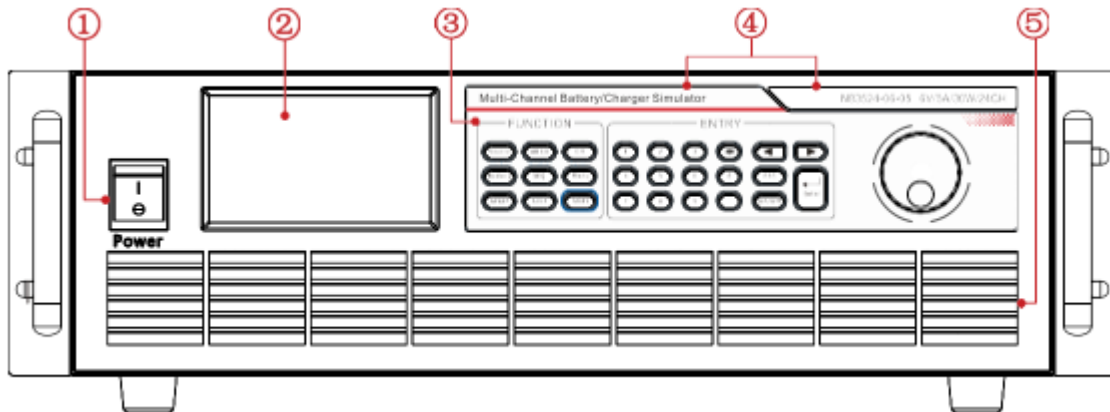

Figure 19 Front Panel

Table 3

Number	Name	Function
1	Power switch	Power control
2	Screen	Displaying data
3	Buttons	Operation mode and parameter setting
4	Device model	Displaying model number
5	Air outlet	Exhaust outlet, cooling

### 4.4.1 Button & Knob

Users can control BCS via button and knob.

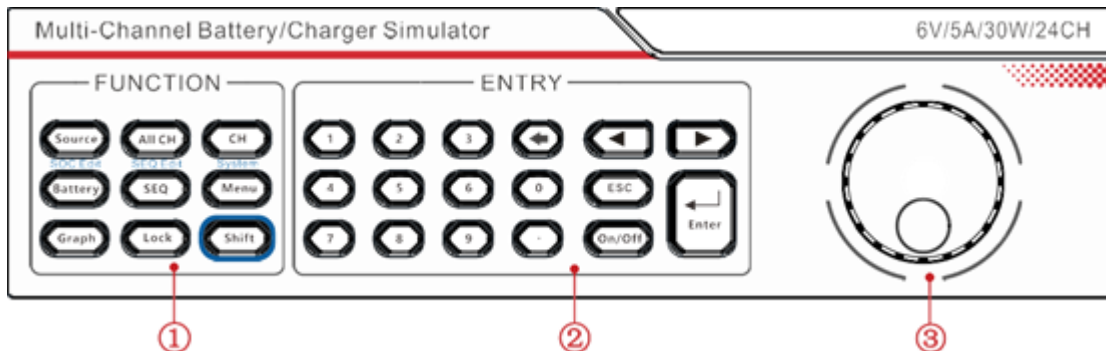

Figure 20 Button & Knob

Table 4

Number	Name
1	Function buttons
2	Numeric buttons
3	Knob

## 4.4.2 Function Button

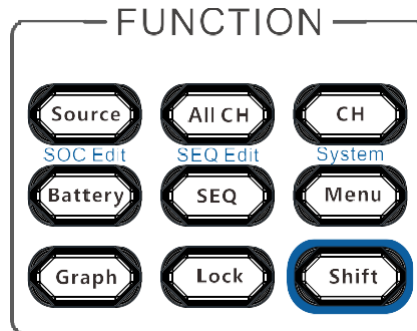

Figure 21 Function Button

Table 5

Button	Function
	To enter Source mode
	To enter all channels readback interface
	Channel switch
	To enter battery simulation /SOC Edit
	To enter SEQ Test /SEQ Edit
	Menu or system setting
	To enter Graph interface
	To lock/unlock
	Compound button, Shift+Battery/SEQ/Menu to enter SOC Edit or SEQ Edit/System

## 4.4.3 Numeric Button

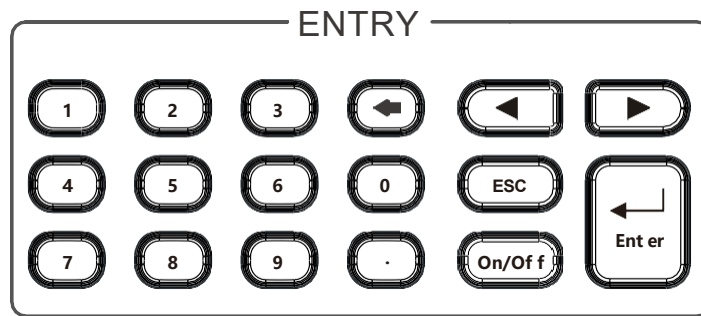

Figure 22 Numeric Button

Table 6

Button	Function
	Digit input
	To delete
	<ol style="list-style-type: none"> <li>To shift or select the required item in menu</li> <li>To control the cursor scrolling when setting parameter</li> </ol>
	To enter the required item, confirm the input, exit from setting or remote operation
	To exit from setting
	To turn on/off the power output for the selected channel

## 4.4.4 Knob

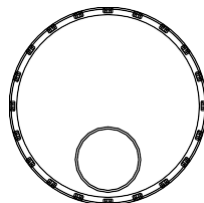
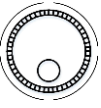

Figure 23 Knob

Table 7

Knob	Function
	By rotating: to select the required item, adjust the parameter By pressing: to enter the edit interface, confirm the input

## 4.5 Rear Panel Introduction

### 4.5.1 Regular

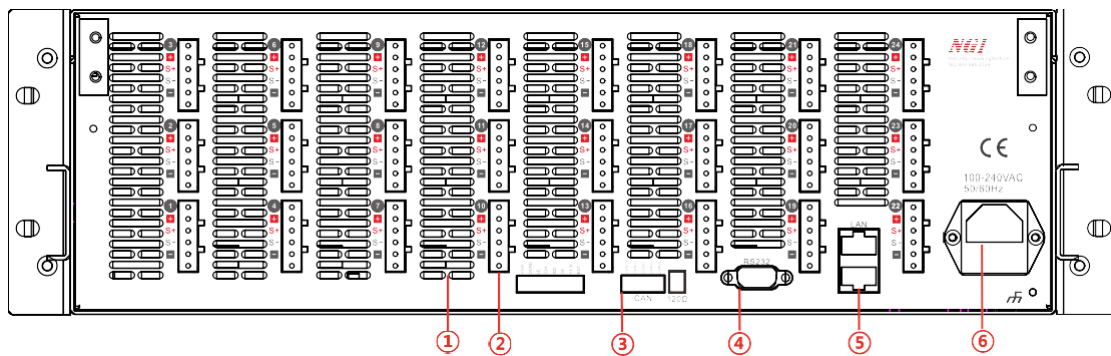

Figure 24 Rear Panel

Table 8

Number	Name	Function
1	Air outlet	Exhaust outlet, cooling
2	Channel interface	Channel output
3	CAN interface	For remote control
4	RS232 interface	For remote control
5	LAN port	For remote control
6	AC power socket	AC input power

## 4.5.2 Optional

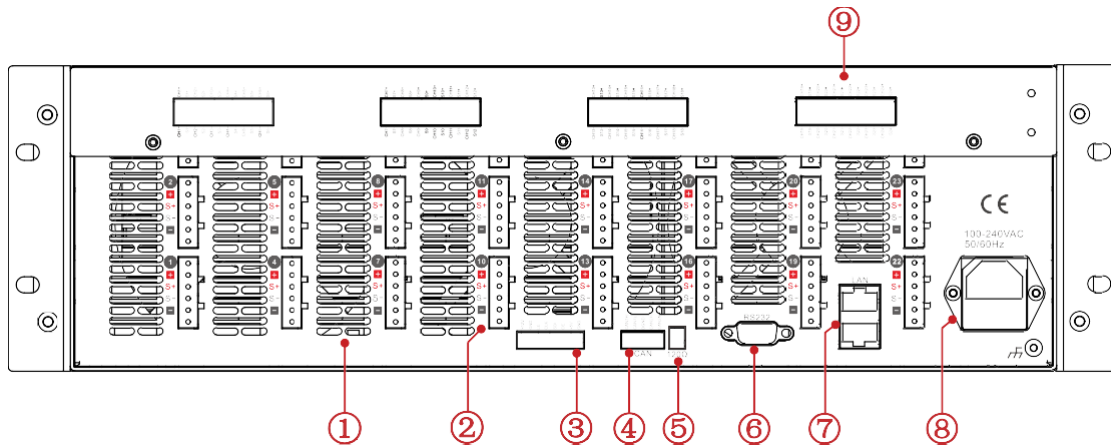

Figure 25 Rear Panel

Table 9

Number	Name	Function
1	Air outlet	Exhaust outlet, cooling
2	Channel interface (regular)	Channel output (regular)
3	Fault simulation control terminal	Control power supply and relay
4	CAN interface	For remote control
5	120Ω resistance	Settable resistance, default as off
6	RS232 interface	For remote control
7	LAN port	For remote control
8	AC power socket	AC input power
9	Channel interface (optional)	Channel output (optional)

## 4.5.3 Channel Interface (Regular)

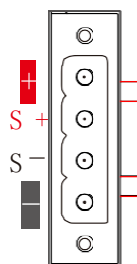

Figure 26 Channel Interface (Regular)

When the instrument outputs a high current, a voltage drop occurs on the output wire. In order to ensure the measurement accuracy, BCS adopts the four-wire

output mode to compensate the wire voltage drop.

Table 10 Pin Definition

Symbol	Definition
+	Four-wire system output +
S+	Four-wire system sense +
S-	Four-wire system sense -
-	Four-wire system output -

## Notes

The maximum limit of the output/input voltage between the channel interface (+) and (-) is the rated voltage.

The maximum limit of the output/input current between the channel interface (+) and (-) is the rated current.

### 4.5.4 Channel Interface (Optional)

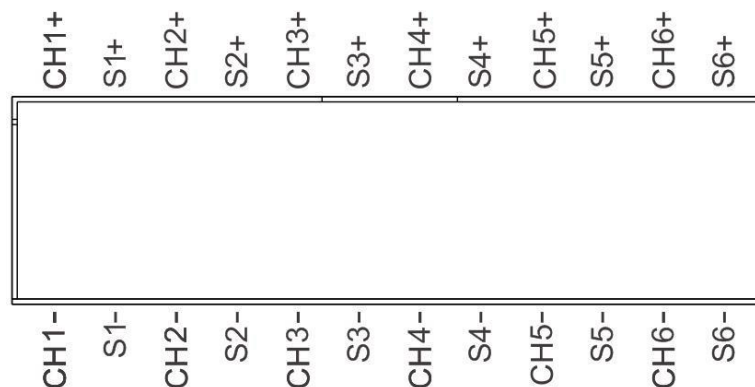

Figure 27 Channel Interface (Optional)

When the instrument outputs a high current, a voltage drop occurs on the output wire. In order to ensure the measurement accuracy, BCS adopts the four-wire output mode to compensate the wire voltage drop.

Table 11 Pin Definition

Symbol	Definition
--------	------------

CH1+	Four-wire system output +
S1+	Four-wire system sense +
S1-	Four-wire system sense -
CH1-	Four-wire system output -

## Notes

The maximum limit of the output/input voltage between the channel interface (+) and (-) is the rated voltage\*1.2.

The maximum limit of the output/input current between the channel interface (+) and (-) is the rated current.

Table12 BCS+NB108-2 The current driven by different voltage.

Single channel	
Voltage /V	Input Current Range
0.1	0-400mA
0.5	0-2A
1	0-4.5A
1.2	0-5A
Multichannel connected in series	
Voltage /V	Input Current Range
0.1	0-300mA
0.5	0-1.5A
1	0-3A
1.6	0-5A

### 4.5.5 RS232 Interface

On the rear panel, there is a male DB-9 interface with 9 pins.

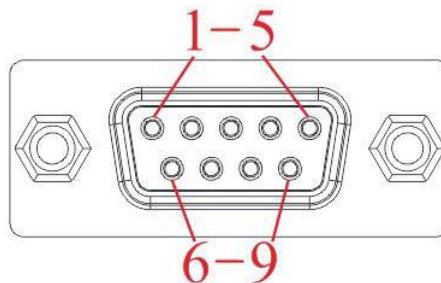

Figure 28 RS232 Interface

Table 13 RS232 Pin Definition

Pin	Definition
1	NC
2	RXD, receive data
3	TXD, transmit data
4	NC
5	GND, ground
6	NC
7	NC
8	NC
9	NC

## 4.5.6 LAN Port

There are two LAN ports at BCS rear panel. Users can choose either LAN port to connect BCS with computer by an Ethernet cable.

The double LAN design offers feasibility of one computer controlling multiple devices. Below figure shows one computer controlling two devices.

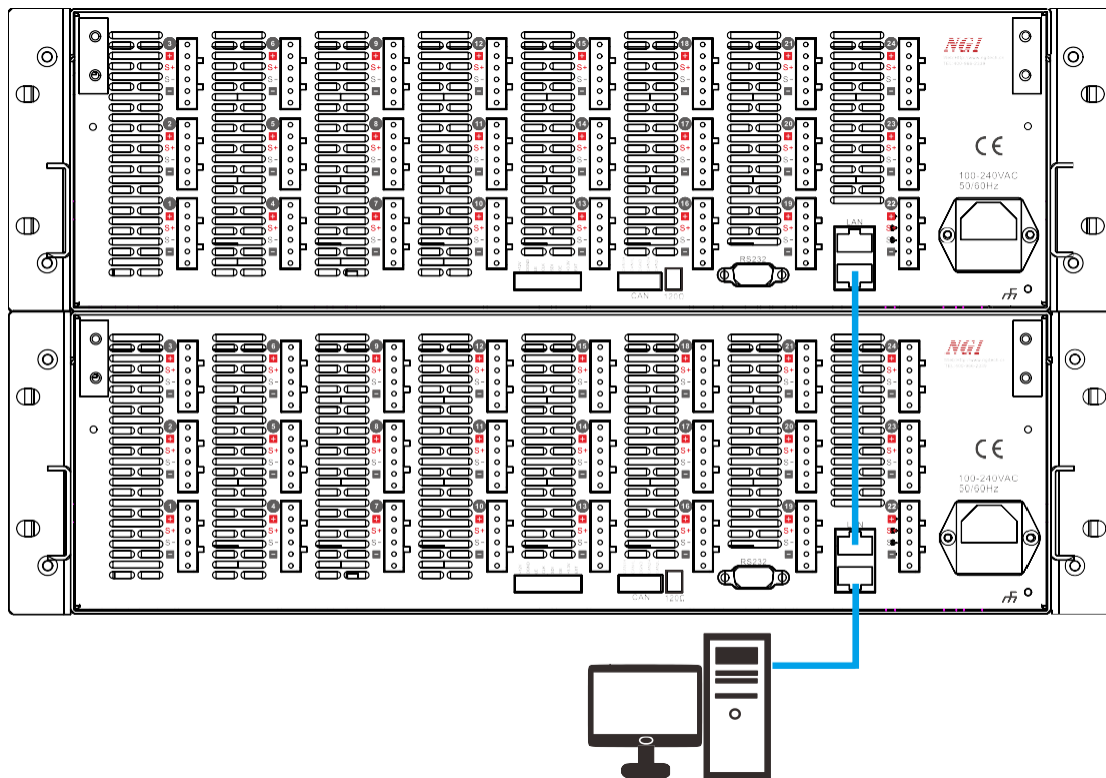

Figure 29 Multiple Devices Connection Diagram



## Notes

BCS is equipped with three communication interfaces, RS232, LAN and CAN. Users can choose any one to communicate with the computer.

### 4.5.7 CAN Interface

BCS is equipped with a CAN bus interface.

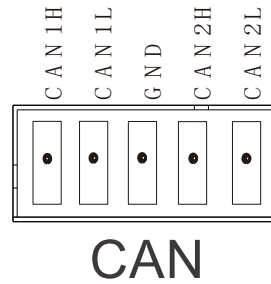

Figure 30 RS232 Interface

Table 14 CAN Pin Definition

Pin	Definition
CAN1H	Dominant level
CAN1L	Recessive level
GND	Ground
CAN2H	Dominant level
CAN2L	Recessive level

Users can realize PC communication control through the USB to CAN converter. The connection diagram is shown below.

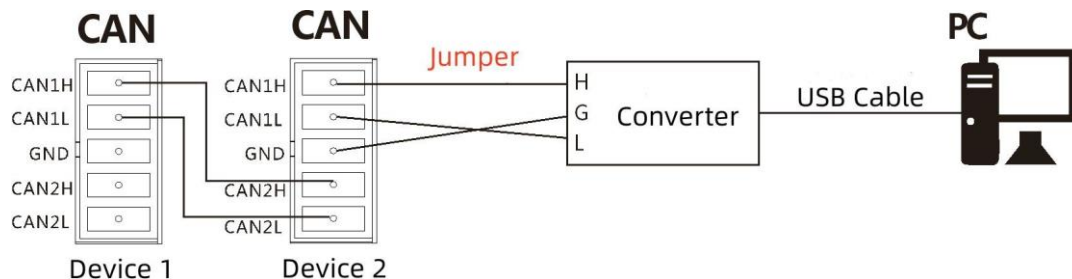

Figure 31 Connection Diagram

## 4.5.8 Default Communication Parameter

Table 15

Parameter	BCS Series Default Value
Default IP Address	192.168.0.123
Default Baud Rate	115200

## 5 Operation

After the device is switched on, it will enter Source mode directly. Users can enter menu by pressing [Menu]. There are fourteen options on the menu: Source, Charge, Battery, SOC Test, SOC Edit, SEQ Test, SEQ Edit, All CH, Fault, Graph, System, Protection, CAN Set and About Us.

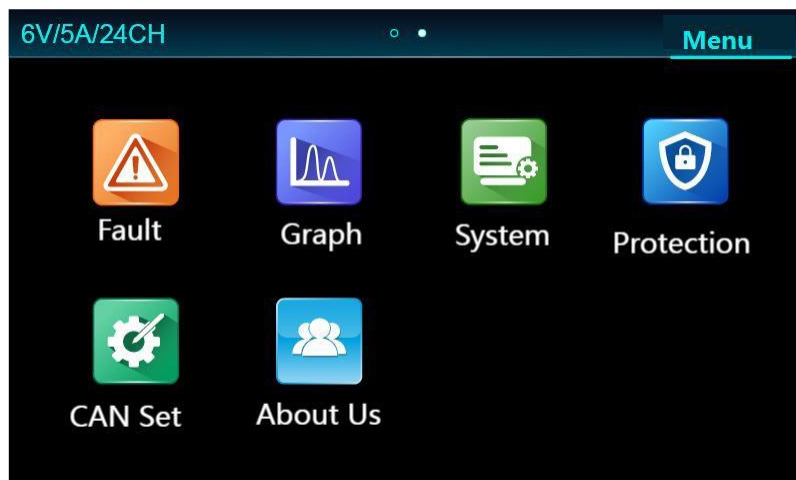
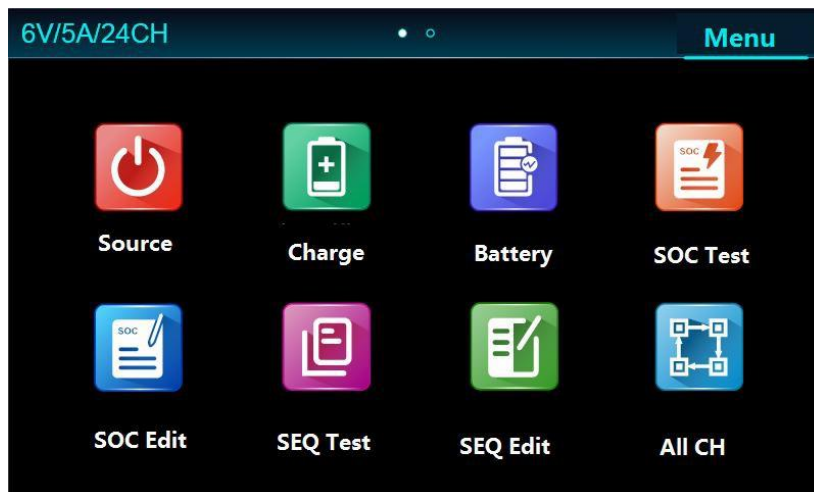

Figure 32 Menu

This chapter mainly describes the following functions of BCS.

- Source
- Charge
- Battery
- SOC Edit
- SOC Test
- SEQ Edit
- SEQ Test
- Graph
- All CH
- System
- Protection
- Fault (Optional)
- CAN Set
- About Us

## 5.1 Interface



Figure 33 Interface Introduction

Table 16

Number	Instruction
1	Specification
2	Readback area, including voltage, current, power, capacity, temperature. Please press [ <b>Shift</b> ] first, release the button and then press ◀▶ to switch the parameters.
3	Channel status, including ON/OFF, function mode, OVP/OCP/OPP, etc.
4	Parameter setting area
5	Function mode

## 5.2 Source Mode

BCS source mode is constant voltage and current limit.

Methods to enter **Source** mode:

Method 1: It will directly enter **Source** mode after power-on.

Method 2: Press [**Source**] on the front panel directly.

Method 3: Press [**Menu**]→ Select [**Source**] by pressing ◀▶ or rotating the knob→ Press the knob or [**Enter**].

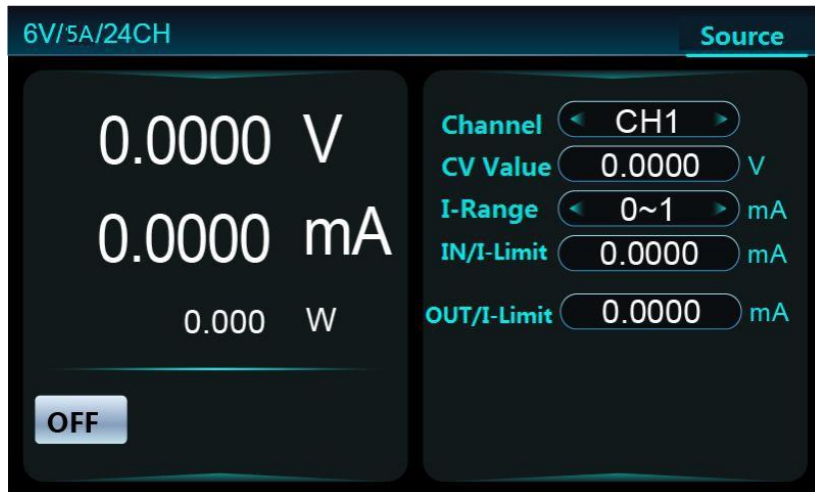

Figure 34 Source Mode

Table 17

Parameter	Description
Channel	To select channel number
CV Value	To set constant voltage value
I-Range	To select current readback range
IN/I-Limit	To set input current limit
OUT/I-Limit	To set output current limit

## 5.2.1 Parameter Setting

### ■ Channel Selection

Channel selection refers to selecting the present channel to edit parameters or run the present channel.

Methods to select the required channel under **Source** mode:

Method 1: Press [**CH**] directly on the front panel.

Method 2: Press ◀▶ to select **Channel**→ Press [**Enter**] or the knob on **Channel**→ Press ◀▶ to select the required channel→ Press [**Enter**] or the knob to complete selection.

Method 3: Rotate the knob to select **Channel**→ Press [**Enter**] or the knob on **Channel**→ Rotate the knob to select the required channel→ Press [**Enter**] or the knob to complete selection.

Users can select option **ALL** to turn on/off all channels.

## ■ Current Range

Current range is the current readback range, including three options: high range, low range, and automatic range. When the device is set to automatic range, the readback current range will automatically switch the range according to the actual current value. After switching the range, users needs to press ON again to take effect.

Steps to select the required current range under **Source** mode:

1. Press ◀▶ or rotate the knob to select **I-Range**.
2. Press [Enter] or the knob on **I-Range**.
3. Press ◀▶ or rotate the knob to select the range required.
4. Press [Enter] or the knob to complete selection.

## ■ CV Value

The settable range is from 0 to rated voltage.

## ■ Input/Output Current Limit

The settable range of IN/I-Limit or OUT/I-Limit is from 0 to rated current. The actual input/output current will not exceed the setting value.

Methods to set **CV Value** or **IN/I-Limit** or **OUT/I-Limit** under **Source** mode:

**Method 1:** Press ◀▶ or rotate the knob to select **CV Value** or **IN/I-Limit** or **OUT/I-Limit**→Press [Enter] or the knob on **CV Value** or **IN/I-Limit** or **OUT/I-Limit**→Press numeric buttons to input the value→Press [Enter] or the knob to complete setting.

**Method 2:** Press ◀▶ or rotate the knob to select **CV Value** or **IN/I-Limit** or **OUT/I-Limit**→Press [Enter] or the knob on **CV Value** or **IN/I-Limit** or **OUT/I-Limit**→Press◀▶to move the cursor and rotate the knob to adjust the numeric→Press [Enter] or the knob to complete setting.

## 5.2.2 Operation Example

Step 1: Select the channel to CH1.

Step 2: Set **CV Value** to 5V and press [Enter].

Step 3: Set **I-Range** to 0~1 and press [Enter].

Step 4: Set **IN/I-Limit** to 1mA and press [Enter].

Step 5: Set **OUT/I-Limit** to 1mA and press [Enter].

Step 6: Connect a 5kΩ and press [ON/OFF] to enable output.

Step 7: The LCD screen shows the data.

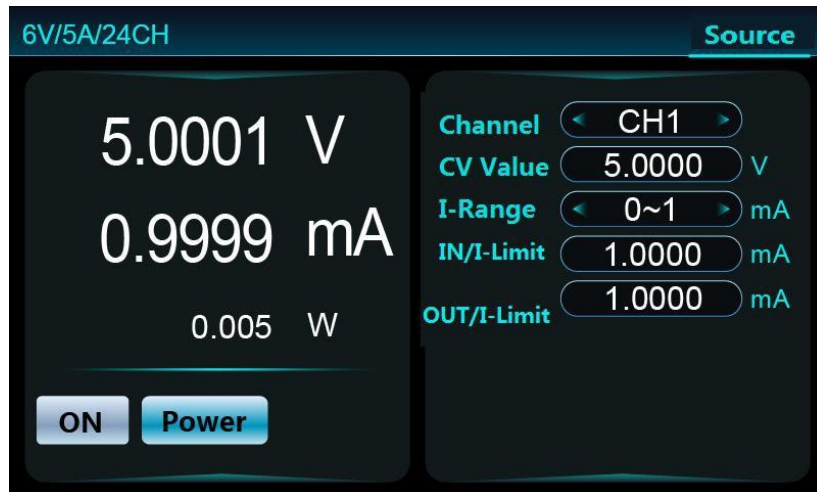

Figure 35 Source Mode

Step 8: After the test completed, press [ON/OFF] to shut off output.

## 5.3 Charge

Charge mode can be used to simulate battery charging and discharging.

Steps to enter **Charge** mode:

1. Press [Menu] on the front panel.
2. Choose **Charge** by pressing ◀▶ or rotating the knob.
3. Press [Menu] or the knob.

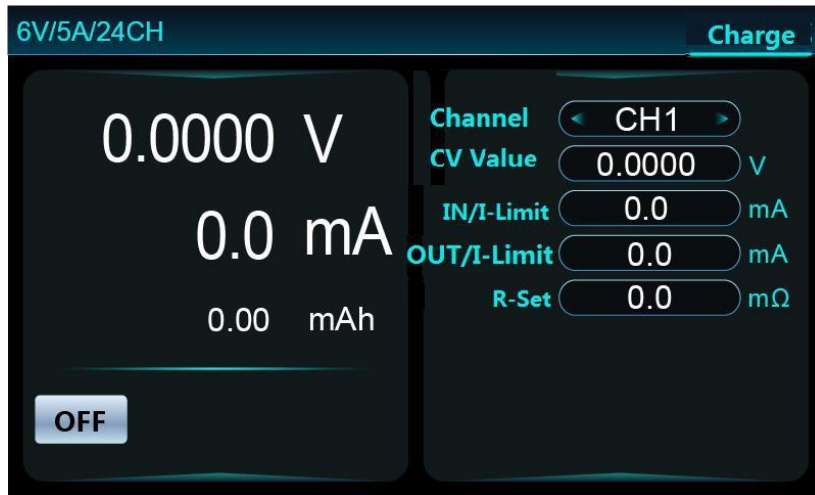

Figure 36 Charge Mode

Table 18

Parameter	Description
Channel	To select channel number
CV Value	To set constant voltage value
IN/I-Limit	To set input current limit
OUT/I-Limit	To set output current limit
R-Set	To set resistance value

### 5.3.1 Parameter Setting

#### ■ Channel Selection

Channel selection refers to selecting the present channel to edit parameters or run the present channel.

Methods to select the required channel under **Charge** mode:

Method 1: Press **[CH]** directly on the front panel.

Method 2: Press ◀▶ to select **Channel**→ Press **[Enter]** or the knob on **Channel**→ Press ◀▶ to select the required channel→ Press **[Enter]** or the knob to complete selection.

Method 3: Rotate the knob to select **Channel**→ Press **[Enter]** or the knob on **Channel**→ Rotate the knob to select the required channel→ Press **[Enter]** or the knob to complete selection.

Users can select option **ALL** to turn on/off all channels.



## ■ Input/Output Current Limit

The settable range of IN/I-Limit or OUT/I-Limit is from 0 to rated current. The actual input/output current will not exceed the setting value.

## ■ CV Value

The settable range is from 0 to rated voltage.

## ■ Simulated Resistance

The settable range is from 0mΩ to 99999.9mΩ.

Methods to set **CV Value** or **IN/I-Limit** or **OUT/I-Limit** or **R-Set** under **Charge** mode:

**Method 1:** Press ◀ ▶ or rotate the knob to select **CV Value** or **IN/I-Limit** or **OUT/I-Limit** or **R-Set**→Press [Enter] or the knob on **CV Value** or **IN/I-Limit** or **OUT/I-Limit** or **R-Set**→Press numeric buttons to input the value→Press [Enter] or the knob to complete setting.

**Method 2:** Press ◀ ▶ or rotate the knob to select **CV Value** or **IN/I-Limit** or **OUT/I-Limit** or **R-Set**→Press [Enter] or the knob on **CV Value** or **IN/I-Limit** or **OUT/I-Limit** or **R-Set**→Press ◀▶ to move the cursor and rotate the knob to adjust the numeric→Press [Enter] or the knob to complete setting.

## 5.3.2 Operation Example

Step 1: Select the channel to CH1.

Step 2: Set **CV Value** to 1V and press [Enter].

Step 3: Set **IN/I-Limit** to 500mA and press [Enter].

Step 4: Set **OUT/I-Limit** to 500mA and press [Enter].

Step 5: Set **R-Set** to 0mΩ and press [Enter].

Step 6: Connect a battery and press [ON/OFF] to enable output.

Step 7: The LCD screen shows the data.

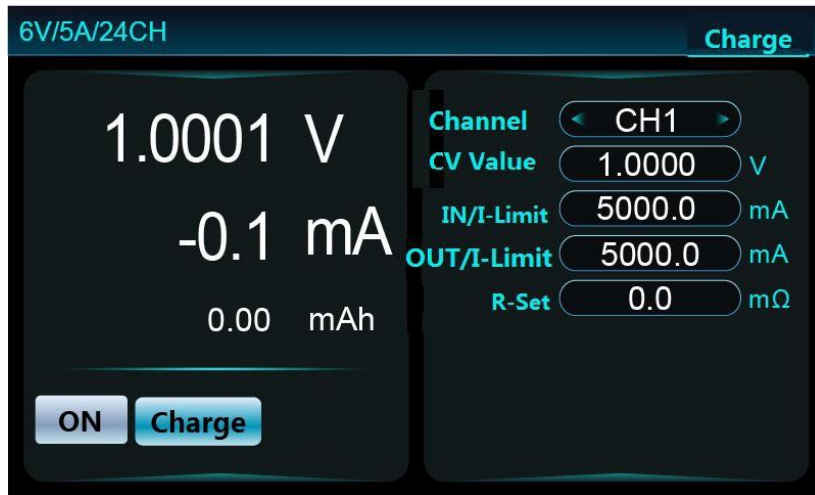

Figure 37 Charge Mode

Step 8: After the test completed, press [ON/OFF] to shut off output.

## 5.4 Battery

Methods to enter **Battery** mode:

Method 1: Press [**Battery**] on the front panel directly.

Method 2: Press [**Menu**]→ Select [**Battery**] by pressing ◀▶ or rotating the knob→ Press the knob or [**Enter**].

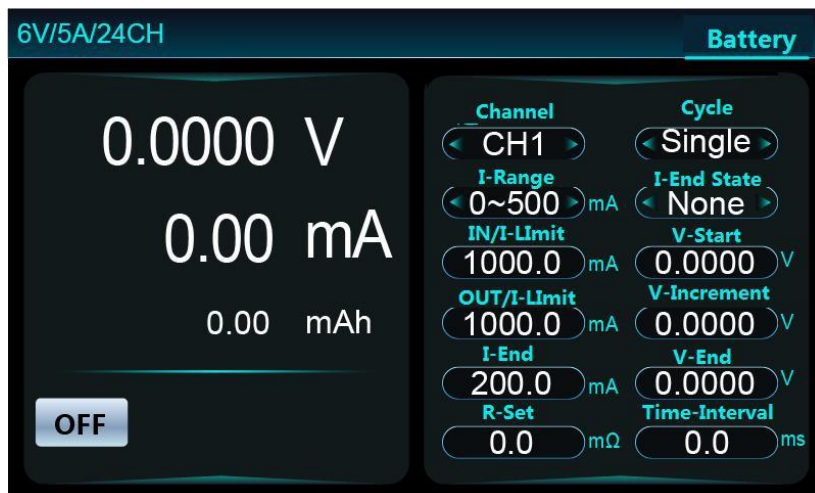

Figure 38 Battery Simulation

Table 19

Parameter	Description
Channel	To select channel number
I-Range	To select current range
IN/I-Limit	To set input current limit. The range is from 0mA to maximum input current limit.
OUT/I-Limit	To set output current limit. The range is from 0mA to maximum output current limit.
I-End	To set end current
R-Set	To set resistance value
Cycle	To select cycle mode. Options: Single and Cont.
I-End State	To select condition of cut-off current. When current meets the condition, BCS will stop running.
V-Start	To set start voltage
V-Increment	To set voltage increment for single step
V-End	To set stop voltage
Time Interval	To set the time interval

## 5.4.1 Parameter Setting

### ■ Channel Selection

Channel selection refers to selecting the present channel to edit parameters or run the present channel.

Methods to select the required channel under **Battery** mode:

Method 1: Press **[CH]** directly on the front panel.

Method 2: Press ◀▶ to select **Channel**→ Press **[Enter]** or the knob on **Channel**→ Press ◀▶ to select the required channel→ Press **[Enter]** or the knob to complete selection.

Method 3: Rotate the knob to select **Channel**→ Press **[Enter]** or the knob on **Channel**→ Rotate the knob to select the required channel→ Press **[Enter]** or the knob to complete selection.

Users can select option **ALL** to turn on/off all channels.

## ■ Cycle Mode

The options for cycle mode: Single or Continuous.

Single: It means it will maintain end voltage after completing the test.

Continuous: It means the voltage will be reassigned to start voltage after completing the test.

## ■ Current End State

When the current meets the conditions, it will respond accordingly.

None: Invalid

≥: loop current greater than or equal to end current

≤: loop current less than or equal to end current

## ■ Current Range

Current range is the current readback range, including three options: high range, low range, and automatic range. When the device is set to automatic range, the readback current range will automatically switch the range according to the actual current value. After switching the range, users need to press ON again to take effect.

Steps to select the required cycle mode or current end state or current range under **Battery** mode:

1. Press ◀▶ or rotate the knob to select **Cycle** or **I-End State** or **I-Range**.
2. Press [Enter] or the knob on **Cycle** or **I-End State** or **I-Range**
3. Press ◀▶ or rotate the knob to select the option required.
4. Press [Enter] or the knob to complete selection.

## ■ Input/Output Current Limit

The settable range of IN/I-Limit or OUT/I-Limit is from 0 to rated current. The actual input/output current will not exceed the setting value.

## ■ End Current

The loop current is compared with end current. When the loop current meets the current end state, the device will perform relevant processing.

## ■ Simulated Resistance

The settable range is from 0mΩ to 99999.9mΩ.

■ Start Voltage, Increment Voltage, End Voltage, Time Interval

Start voltage refers to the starting voltage of the device. The voltage increases in time intervals until it reaches the end voltage.

Methods to set **IN/I-Limit** or **OUT/I-Limit** or **I-End** or **R-Set** or **V-Start** or **V-Increment** or **V-End** or **Time Interval** under **Battery** mode:

**Method 1:** Press ◀▶ or rotate the knob to select **IN/I-Limit** or **OUT/I-Limit** or **I-End** or **R-Set** or **V-Start** or **V-Increment** or **V-End** or **Time Interval** →Press [Enter] or the knob on **IN/I-Limit** or **OUT/I-Limit** or **I-End** or **R-Set** or **V-Start** or **V-Increment** or **V-End** or **Time Interval** →Press numeric buttons to input the value→Press [Enter] or the knob to complete setting.

**Method 2:** Press ◀▶ or rotate the knob to select **IN/I-Limit** or **OUT/I-Limit** or **I-End** or **R-Set** or **V-Start** or **V-Increment** or **V-End** or **Time Interval** →Press [Enter] or the knob on **IN/I-Limit** or **OUT/I-Limit** or **I-End** or **R-Set** or **V-Start** or **V-Increment** or **V-End** or **Time Interval** →Press ◀▶ to move the cursor and rotate the knob to adjust the numeric→Press [Enter] or the knob to complete setting.

## 5.4.2 Operation Example

Step 1: Select the channel to CH1.

Step 2: Set **Cycle** to Single and press [Enter].

Step 3: Set **I-Range** to Auto and press [Enter].

Step 4: Set **IN/I-Limit** to 5000mA and press [Enter].

Step 5: Set **OUT/I-Limit** to 5000mA and press [Enter].

Step 6: Set **I-End** to 200mA and press [Enter].

Step 7: Set **R-Set** to 0mΩ and press [Enter].

Step 8: Set **I-End State** to None.

Step 9: Set **V-Start** to 1V and press [Enter].

Step 10: Set **V-Increment** to 0.5V and press [Enter].

Step 11: Set **V-End** to 2V and press [Enter].

Step 12: Set **Time Interval** to 500ms and press [Enter].

Step 13: Connect a test object and press [ON/OFF] to enable output.

Step 14: The LCD screen shows the data.

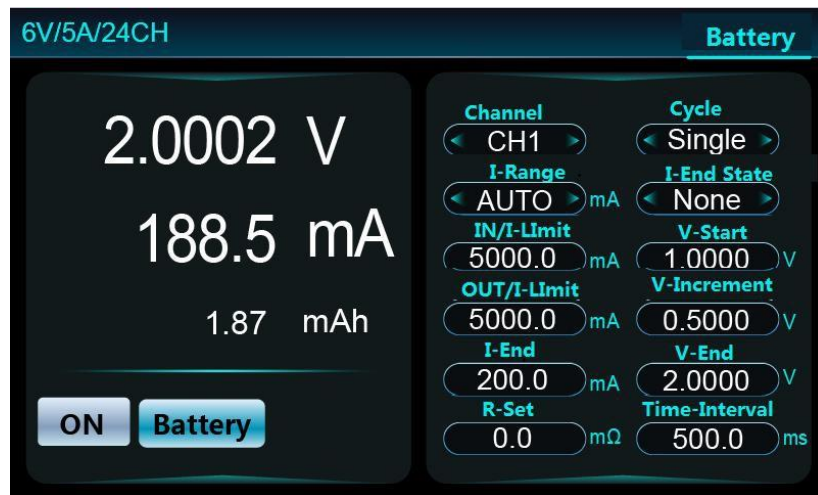

Figure 39 Battery Simulation

Step 15: After the test completed, press [ON/OFF] to shut off output.

## 5.5 SOC Edit

The SOC function simulates battery charging and discharging. During the battery charging and discharging process, the larger the battery capacity is, the higher the battery open circuit voltage and the lower the battery internal resistance are. On the contrary, when the capacity decreases, the battery open circuit voltage decreases and the internal resistance increases.

Under SOC edit, users can edit multiple steps to form a test program. Up to 8 files can be edited (File 1 ~ File 8). Up to 200 steps can be configured per SOC file. Users can edit the capacity, constant voltage value, input/output current limit and simulated internal resistance of each single step. After editing is completed, users can enter SOC test interface to execute the edited test steps.

Methods to enter **SOC Edit**:

Method 1: Press [Shift] first and then [Battery] on the front panel.

Method 2: Press [Menu]→ Select [SOC Edit] by pressing ◀▶ or rotating the knob→ Press the knob or [Enter].

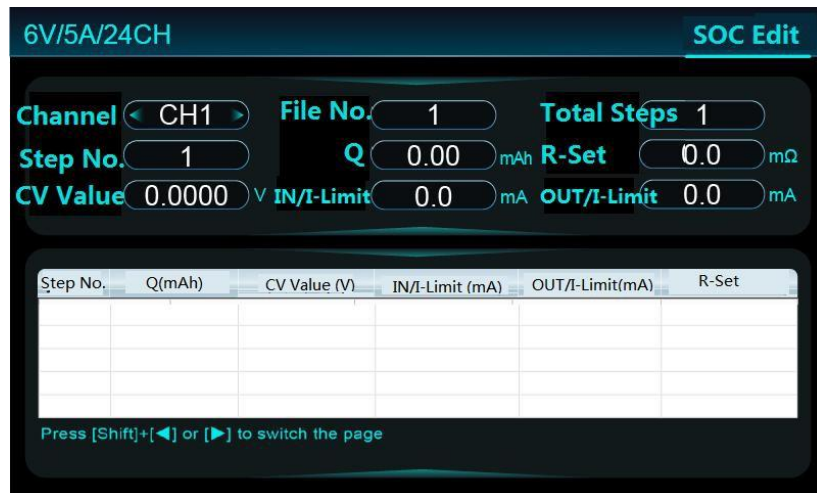

Figure 40 SOC Edit

Table 20

Parameter	Description
Channel	To select channel number
File No.	To set SOC test file number, range: 1-8
Total Steps	To set the total operation steps. Range: 0-200
Step No.	To set the specific step number. Range:1-200
Q	To set the initial capacity for the corresponding step number
R-Set	To set resistance value,range: 0mΩ-99999.9mΩ
CV Value	To set constant voltage value,range: 0 to rated voltage
IN/I-Limit	To set input current limit
OUT/I-Limit	To set output current limit. Loop current should be less than OUT/I-Limit.

## 5.5.1 Parameter Setting

### ■ Channel Selection

Channel selection refers to selecting the present channel to edit parameters or run the present channel.

Methods to select the required channel under **SOC Edit** mode:

Method 1: Press [CH] directly on the front panel.

Method 2: Press ◀▶ to select **Channel**→ Press [Enter] or the knob on **Channel**→

Press ◀▶ to select the required channel → Press [Enter] or the knob to complete selection.

Method 3: Rotate the knob to select **Channel** → Press [Enter] or the knob on **Channel** → Rotate the knob to select the required channel → Press [Enter] or the knob to complete selection.

Users can select option **ALL** to turn on/off all channels.

## ■ File No.

It refers to the work step file executed when the device is running. Settable range is 1-8.

## ■ Total Steps

It refers to the total steps executed when the device is running. Settable range is 0-200.

## ■ Step No.

After setting the step number, users can set corresponding parameters. Settable range is 1-200.

## ■ Capacity

It refers to the capacity for the step under editing.

## ■ Constant Voltage

Settable range is from 0 to rated voltage.

## ■ Simulated Resistance

Settable range is from 0mΩ-99999.9mΩ.

## ■ Input/Output Current Limit

The settable range of IN/I-Limit or OUT/I-Limit is from 0 to rated current. The actual input/output current will not exceed the setting value.

Methods to set **File No.** or **Total Steps** or **Step No.** or **Q** or **R-Set** or **CV Value** or **IN/I-Limit** or **OUT/I-Limit** under **SOC Edit**:

**Method 1:** Press ◀▶ or rotate the knob to select **File No.** or **Total Steps** or **Step No.** or **Q** or **R-Set** or **CV Value** or **IN/I-Limit** or **OUT/I-Limit** → Press [Enter] or the knob on **File No.** or **Total Steps** or **Step No.** or **Q** or **R-Set** or **CV Value** or **IN/I-Limit** or



**OUT/I-Limit** →Press numeric buttons to input the value→Press [Enter] or the knob to complete setting.

**Method 2:** Press ◀▶ or rotate the knob to select **File No.** or **Total Steps** or **Step No.** or **Q** or **R-Set** or **CV Value** or **IN/I-Limit** or **OUT/I-Limit** →Press [Enter] or the knob on **File No.** or **Total Steps** or **Step No.** or **Q** or **R-Set** or **CV Value** or **IN/I-Limit** or **OUT/I-Limit** →Press ◀▶ to move the cursor and rotate the knob to adjust the numeric→Press [Enter] or the knob to complete setting.

## 5.5.2 Operation Example

Step 1: Select the channel to CH1.

Step 2: Set **File No.** to 4 and press [Enter].

Step 3: Set **Total Steps** to 20 and press [Enter].

Parameters for step 1 to step 20 (lead-acid battery discharge model)

Table 21

Step No.	Capacity (mAh)	Constant Voltage (V)	Input Current Limit (mA)	Output Current Limit (mA)	Resistance (mΩ)
1	10000.00	2.1000	5000.0	5000.0	10.0
2	9600.00	2.0900	5000.0	5000.0	11.0
...	...	...	...	...	...
18	2000.00	1.7700	5000.0	5000.0	71.0
19	1000.00	1.6900	5000.0	5000.0	85.0
20	0.00	1.600	5000.0	5000.0	100.0

After the parameters are all set, the screen will show as below picture.

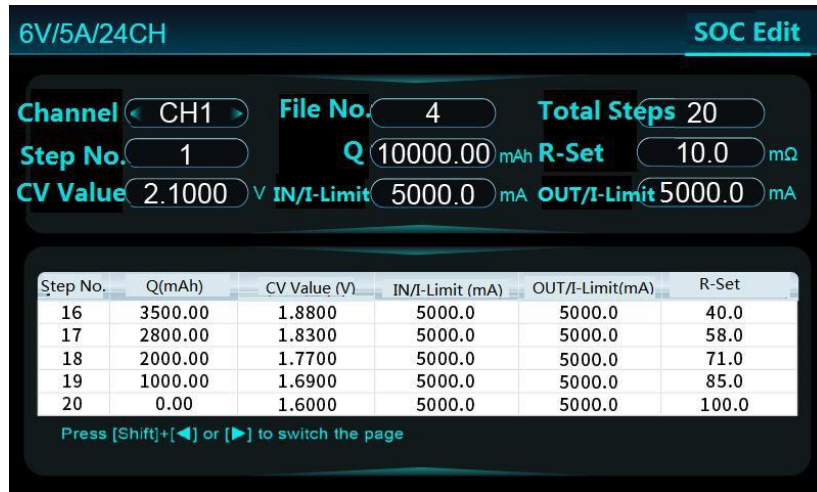

Figure 41 SOC Edit

Note: To exit from **SOC Edit**, please press [**Menu**] or the function button required.

## 5.6 SOC Test

After completing SOC Edit, users can enter SOC Test, select the required channel, set the required SOC file number, set initial voltage and turn on the output to run the test steps.

Steps to enter **SOC Test**:

1. Press [**Menu**] on the front panel.
2. Select **SOC Test** by pressing ◀▶ or rotating the knob.
3. Press [**Enter**] or the knob.

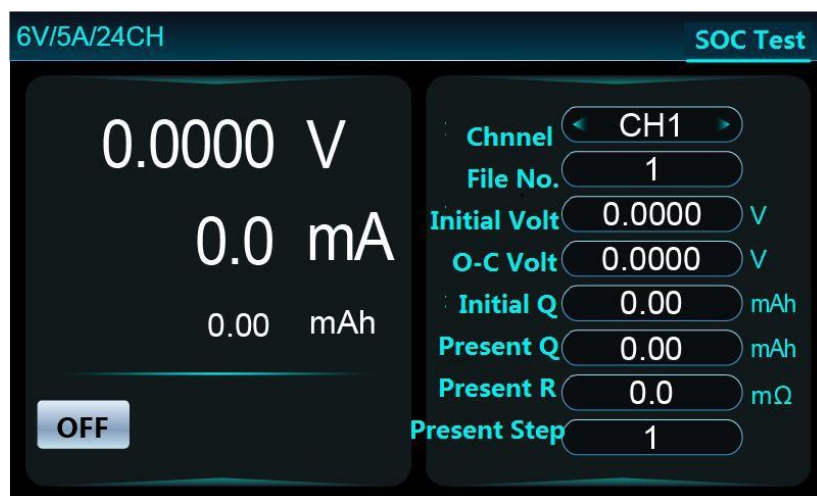

Figure 42 SOC Test

Table 22

Parameter	Description
Channel	To select channel number
File No.	To select the required SOC file No.
Initial Volt	To set start voltage
O-C Volt	Displaying the open circuit voltage
Initial Q	Displaying the starting capacity
Present Q	Displaying the present capacity
Present R	Displaying the internal resistance value
Present Step	Displaying the present test step

## 5.6.1 Parameter Setting

### ■ Channel Selection

Channel selection refers to selecting the present channel to edit parameters or run the present channel.

Methods to select the required channel under **SOC Test**:

Method 1: Press [**CH**] directly on the front panel.

Method 2: Press ◀▶ to select **Channel**→ Press [**Enter**] or the knob on **Channel**→ Press ◀▶ to select the required channel→ Press [**Enter**] or the knob to complete selection.

Method 3: Rotate the knob to select **Channel**→ Press [**Enter**] or the knob on **Channel**→ Rotate the knob to select the required channel→ Press [**Enter**] or the knob to complete selection.

Users can select option **ALL** to turn on/off all channels.

### ■ File No.

Users can select the edited SOC file.

### ■ Initial Voltage

Initial voltage refers to start voltage of simulated battery. After setting, the device will

start to charge or discharge at this voltage.

Methods to set **File No.** or **Initial Volt** under **SOC Test**:

**Method 1:** Press ◀▶ or rotate the knob to select **File No.** or **Initial Volt** →Press [Enter] or the knob on **File No.** or **Initial Volt** →Press numeric buttons to input the value→Press [Enter] or the knob to complete setting.

**Method 2:** Press ◀▶ or rotate the knob to select **File No.** or **Initial Volt**→Press [Enter] or the knob on **File No.** or **Initial Volt**→Press ◀▶ to move the cursor and rotate the knob to adjust the numeric→Press [Enter] or the knob to complete setting.

Note: Initial Volt should be lower than the highest voltage and higher than lowest voltage in the SOC Edit test steps.

## 5.6.2 Operation Example

Step 1: Select the channel to CH1.

Step 2: Set **File No.** to 4 and press [Enter].

Step 3: Set **Initial Volt** to 2.0980V and press [Enter].

Step 4: Connect a test object and press [ON/OFF] to enable output.

Step 5: The LCD screen shows the data.

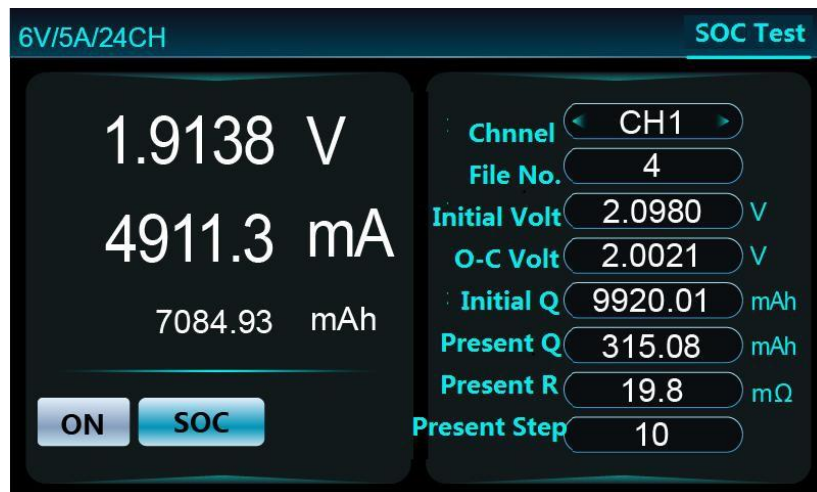

Figure 43 SOC Test

Step 6: After the test completed, press [ON/OFF] to shut off output.

## 5.7 SEQ Edit

Multiple steps can be edited under SEQ Edit. The maximum SEQ files are 10 files with range 1-10. The maximum steps are 200 steps. Constant voltage value, output current limit, input current limit, resistance value and dwell time can be set for each step. Links can also be made between steps. The corresponding cycle times can be set independently.

BCS judges the number of running steps based on the selected SEQ file. It will run all the steps in sequence, according to the preset output parameters for each step.

Methods to enter **SEQ Edit**:

Method 1: Press [**Shift**] first and then [**SEQ**] on the front panel.

Method 2: Press [**Menu**]→ Select [**SEQ Edit**] by pressing ◀▶ or rotating the knob→ Press the knob or [**Enter**].

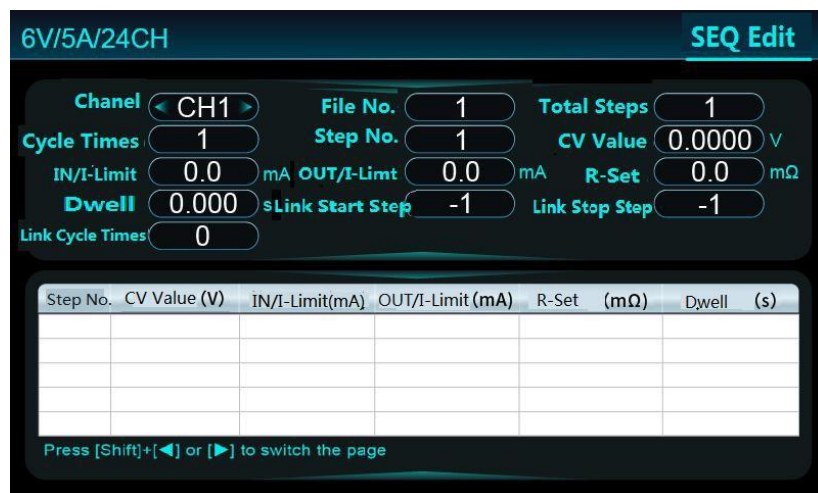

Figure 44 SEQ Edit

Table 23

Parameter	Description
Channel	To select channel number
Cycle Times	To set the number of cycles for the file under edit. Range:0-9999

IN/I-Limit	To set input current limit. Loop current should be less than IN/I-Limit.
Dwell	To set the dwell time for the step under edit
Link Cycle Times	To set cycle times for the link
SEQ File No.	To set the sequence test file number. Range: 1-10
Step No.	To set the step number for editing. Range: 1-200
OUT/I-Limit	To set output current limit. Loop current should be less than OUT/I-Limit.
Link Start Step	To link to the required step after the present step is completed, range -1 to 200. -1 means no link.
Total Steps	To set the total steps of SEQ file. Range: 0-200
CV Value	To set constant voltage value
R-Set	To set resistance value
Link Stop Step	To set the link stop step, range -1 to 200. -1 means no link.

## 5.7.1 Parameter Setting

### ■ Channel Selection

Channel selection refers to selecting the present channel to edit parameters or run the present channel.

Methods to select the required channel under **SEQ Edit**:

Method 1: Press **[CH]** directly on the front panel.

Method 2: Press ◀▶ to select **Channel** → Press **[Enter]** or the knob on **Channel** → Press ◀▶ to select the required channel → Press **[Enter]** or the knob to complete selection.

Method 3: Rotate the knob to select **Channel** → Press **[Enter]** or the knob on **Channel** → Rotate the knob to select the required channel → Press **[Enter]** or the knob to complete selection.

Users can select option **ALL** to turn on/off all channels.

### ■ SEQ File No.

It refers to the work step file executed when the device is running. Settable range is 1-10.

### ■ Total Steps

It refers to the total steps executed when the device is running. Settable range is

0-200.

- File Cycle Times

It refers to the cycle times the SEQ file should run. Settable range is 0-9999.

- Step No.

After setting the step number, users can set corresponding parameters. Settable range is 1-200.

- Constant Voltage

Settable range is from 0 to rated voltage.

- Input/Output Current Limit

The settable range of IN/I-Limit or OUT/I-Limit is from 0 to rated current. The actual input/output current will not exceed the setting value.

- Simulated Resistance

Settable range is from 0mΩ-99999.9mΩ.

- Dwell Time

It refers to the running time for the specific time. Settable range is 0-99.999s.

- Link Start Step No.

Settable range is -1-200. -1 means no link. When this parameter is set to zero or the same value of Step No., it means Link Start Step is same as Step No.

- Link Stop Step No.

Settable range is -1-200. -1 means no link. When this parameter is set to zero or the same value of Step No., it means Link Start Step is same as Step No.

Example:

When the step No. is set to 3, setting Link Start Step/Link Stop Step to zero or 3 means still running step number 3.

- Link Cycle Times

It refers to the cycle times the link step should run.

Example:

For editing Step No. 3, Link Start Step is set to 1, Link Stop Step is set to 2, Link Cycle Times is set to 2. It means after reaching dwell time of step 3, it will run from step 1 to step 2 for twice .

Methods to set the above 12 parameters under **SEQ Edit**:

**Method 1:** Press ◀ ▶ or rotate the knob to select the required parameter → Press [Enter] or the knob on the required parameter → Press numeric buttons to input the value → Press [Enter] or the knob to complete setting.

**Method 2:** Press ◀ ▶ or rotate the knob to select the required parameter → Press [Enter] or the knob on the required parameter → Press ◀ ▶ to move the cursor and rotate the knob to adjust the numeric → Press [Enter] or the knob to complete setting.

## 5.7.2 Operation Example

1. Choose CH1 under Channel selection.
2. Choose file No. and set it to 1, and then enter to confirm.
3. Choose total step and set it to 3, and then enter to confirm.
4. Choose file operating times and set it to 1, and then enter to confirm.

Step No.	CV value(V)	Input current limitation(mA)	Output current limitation(mA)	Simulated internal resistance (mΩ)	Running Time(s)
1	1.5000	100.0	100.0	0.1	3.000
2	3.0000	500.0	500.0	0.1	6.000
3	5.0000	50.0	50.0	0.1	6.000

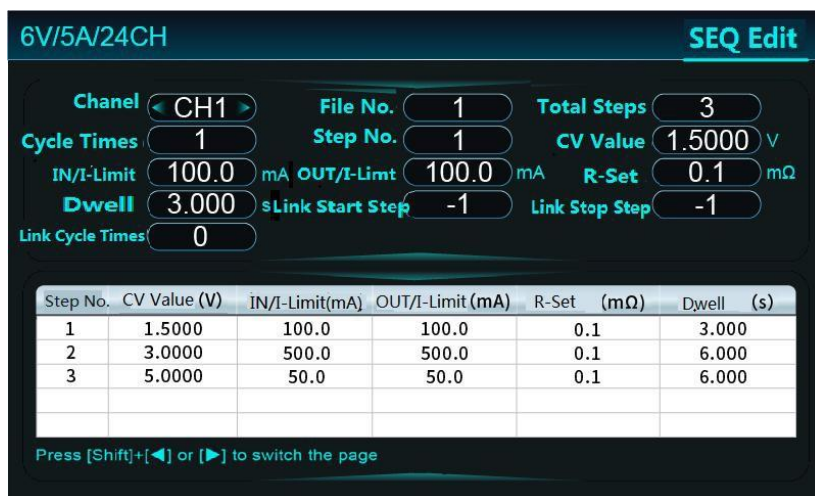



Figure 45 SEQ Edit

## 5.8 SEQ Test

The sequence test mainly determines the step size according to the currently selected running file, and executes sequentially according to the output parameters of each step. The user presses SEQ to enter the "Sequence Test" interface, or selects "Sequence Test" under the "Menu" menu to enter the interface, as shown in Figure 46:

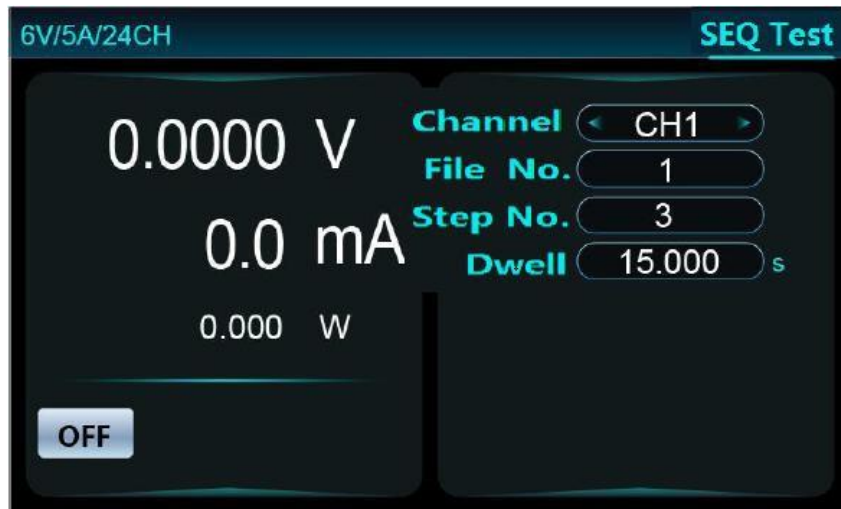

Figure 46 SEQ Test

### 5.8.1 Parameter Setting

- Channel Selection

Refer to Chapter 5.2.1

- File Edit

Select the running file No. currently, Refer to chapter 5.2.1

### 5.8.2 Operation Example

1. Choose CH1 under Channel selection.
2. Choose file No. and set it to 1, and then enter to confirm.

Please note that this operation should be done after SEQ edit finished.

3. Connect the DUT, press ON/OFF button to enable output.

4. Observe the reading data on the screen.

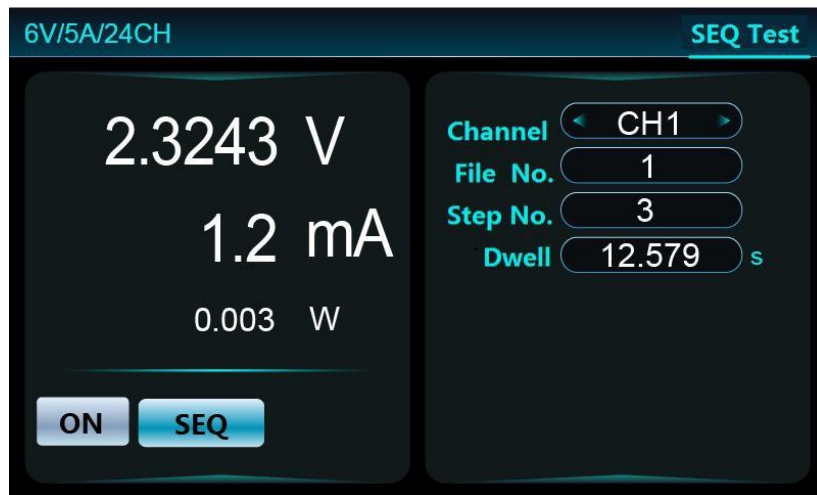

Figure 47 SEQ Test

5. Press ON/OFF button to disable output after test finished.

## 5.9 Graph

Users can press Graph or choose Graph from Menu to enter the screen, as shown in Figure 48:

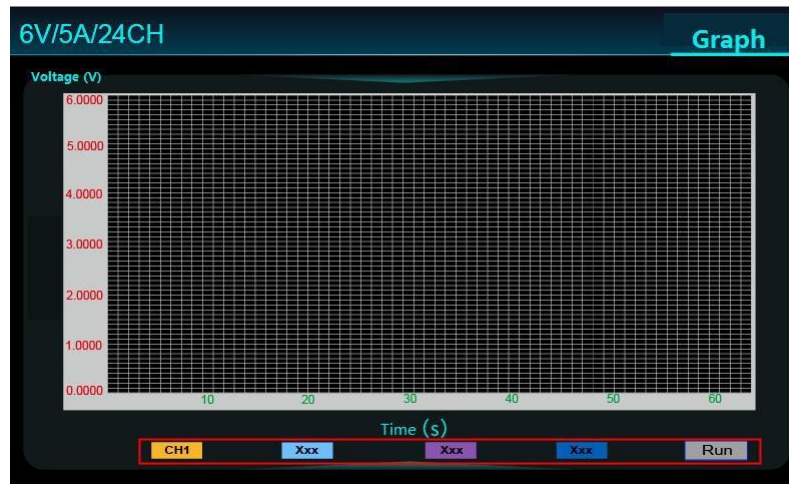

Figure 48 Graph

The real-time curve diagram of any four channels voltage values can be displayed simultaneously.

Operation: Press the "◀▶" key or rotate the "knob" to move the cursor to the channel display bar, press the "knob" to select, then rotate the "knob" to switch the channel, and press the "knob" to confirm.

After setting the channel, move the cursor to the "Run" button and press the "knob" to start.

## 5.10 CAN Set

The user selects CAN Settings to enter the CAN Settings screen, as shown in Figure 49:

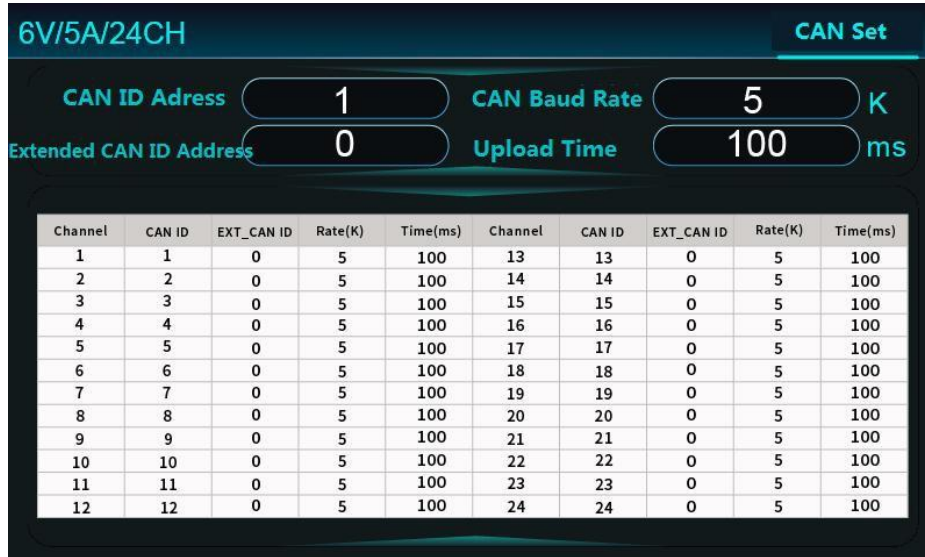

Figure 49 CAN Set

- CAN ID Address

Set the CAN ID address of the device (the default value is 1 and the maximum value is 5). When the CAN ID address is 1, the CAN id of the 24 channels are 1-24 in sequence; when the CAN ID address is 2, the CAN ids of the 24 channels are 25-48 in sequence, and so on.

- CAN Baud Rate

The BCS supports multiple CAN baud rates. A restart takes effect after the baud rate is changed.

The CAN ID address and CAN baud rate parameters are set in the same way. For details, see Section 5.2.1.

- Extended CAN ID Address

The extended ID starting address is 1 by default, and the EXT\_CAN ID assignment for each channel is similar to the CAN ID address. When this address is used, the device transmits data in extended frames.

- Upload Time

The device uploads data once at each interval, and the uploaded data contains

voltage, current, and power.

## 5.11 All View

Users can press All CH or choose All View from Menu to enter the screen, as shown in Figure 50:



Figure 50 All View

In the All view interface, users can view the voltage value, current value, power value and On/Off status of each channel. Press "Shift "+" ◀▶ " to switch to other channels.

## 5.12 System

The System Settings screen is displayed by pressing Shift+Menu, or by selecting System Settings from the Menu menu. You can set related parameters on the system configuration screen, as shown in Figure 51:



Figure 51 System

### ■ IP Address

The default IP address is 192.168.0.123. Users can change the value. After the change is complete, the system restarts to take effect.

To set it up: press the "◀▶" key or rotate the "knob" to move the cursor to the "Network IP" option and press it

Select "Knob" to enter the parameter setting interface. Enter a value using numeric keys and press "Knob" to confirm.

### ■ Baud Rate

The BCS supports a variety of baud rates. Users can select 9600, 19200, 38400, 57600, and 115200 as required. The changes take effect after being restarted.

### ■ Buzzer

This option can set the device key sound ON/OFF.

### ■ Language

The BCS supports Chinese and English display.

## ■ Network connection

This option can set the network connection to UDP/TCP. After the change is complete, the restart takes effect.

## ■ Channel

This option can set the channels, range from CH1 to CH24, All.

## ■ Functional Type and Setting Rate

Functional type includes S/Rate and F/Reset

S/Rate: Fast(10ms) /Medi(120ms) /Slow(480ms), Medi defaulted. F/Reset :

Yes for factory reset , No defaulted. Please refer to the chapter 5.2.1.



## **Note:**

1. After selecting Yes under S/Rate, wait for a moment - No is displayed, then it means that factory restoration is completed.
2. About the selection of function type, please users refer to the actual and combined with the on-screen instructions selected.

## 5.13 Protection

Users can press the "Menu" button and select "Protection" to enter the interface, the protection parameters can be set in the interface.



Figure 52 Protection

### ■ Channel

Please refer to the chapter 5.2.1.

### ■ OVP

If the OVP is triggered, the maximum output voltage will be limited to the protection value, once the OVP is triggered, the output will be shut down immediately and the screen will display the OVP symbol.

### ■ OCP

If the OCP is triggered, the maximum output/input current will be limited to the protection value, once the OCP is triggered, the output will be shut down immediately and the screen will display the OCP symbol.

### ■ OPP

If the OPP is triggered, the maximum output power will be limited to the protection value, once the OPP is triggered, the output will be shut down immediately and the screen will display the OPP symbol.



## 5.14 Fault Simulation (Optional)

The BCS can simulate a variety of battery fault states, including short circuit, negative break, positive break, and opposite polarity. On the Menu menu, choose Fault Simulation to enter the screen, as shown in Figure 53.

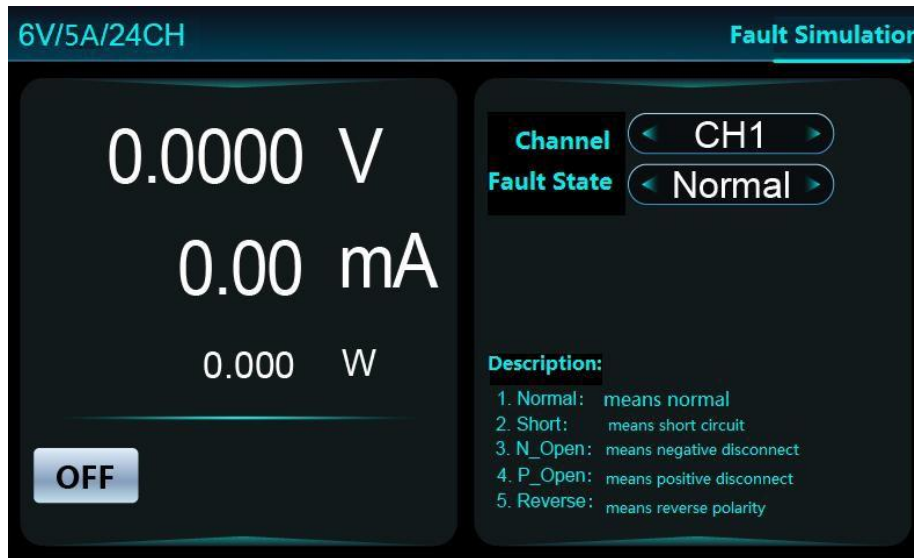

Figure 53 Fault Simulation

- Channel

Please refer to the chapter 5.2.1.

- Fault Sate

Functional type includes Normal, Short, N\_Open, P\_Open, Reverse.

Note: Fault simulation only applies to the source mode, can not be in the charging mode, SOC, SEQ and other modes of fault simulation test; must be set in the operating state of OFF fault simulation and then ON channel.

## 5.15 About Us

Users press "Menu" to enter and select "About Us" to enter the interface, press "Shift", it will show the factory SN number and software version information of BCS.

Figure 54 About Us



## 6 Maintenance and Self-inspection

### 6.1 Regular Maintenance

#### Clean the Device

Please wipe lightly the device with a dry or slightly wet cloth, and do not wipe the inside of it. Make sure the power is disconnected before cleaning.

 **Warning: Disconnect power before cleaning.**

### 6.2 Fault Self-inspection

#### Device Fault Self-inspection

Due to system upgrade or hardware problem, the device may break down. Please do the following necessary inspection to eliminate the troubles, which can save your maintenance and time cost. If the troubles cannot be recovered, please contact REXGEAR.

The inspection steps are as below.

- ◆ Check whether the device is powered.
- ◆ Check whether the device can be turned on normally.
- ◆ Check whether the fuse has no damage.
- ◆ Check whether other connectors are correct, including wire cables, plug, etc.
- ◆ Check whether the system configuration is correct.
- ◆ Check whether all the specifications and performances are within the device working range.
- ◆ Check whether the device displays error information.
- ◆ Operate on a replacement device.

#### Calibration Intervals

It is suggested that BCS series should be calibrated once a year.

## 7 Main Technical Data



Measurement accuracy is recognized when the temperature is 18°C~28°C and the relative humidity reaches 80% within one year after calibration. Also, please warm up for half an hour before accuracy measurement.

**Table 24**

Model	BCS-06-01		BCS-06-03		BCS-06-05	
Current	±1A/CH		±3A/CH		±5A/CH	
Voltage	6V/CH		6V/CH		6V/CH	
Power	6W/CH		18W/CH		30W/CH	
Channel	24CH					
<b>CV Mode</b>						
Range	0~6V					
Setting Resolution	0.1mV					
Setting Accuracy (23±5°C)	0.6mV					
Readback Resolution	0.1mV					
Readback Accuracy (23±5°C)	0.6mV					
Temperature System(0~40°C)	20ppm/°C					
Long-term Stability	80ppm/1000h					
Voltage Ripple (20Hz~20MHz)	≤2mVrms					
<b>CC Mode</b>						
Range	-1~1A	-1~1mA	-3~3A	-1~1mA	-5~5A	-1~1mA
Setting Resolution	0.1mA	0.1μA	0.1mA	0.1μA	0.1mA	0.1μA
Setting Accuracy (23±5°C)	1mA	1μA	3mA	1μA	5mA	1μA
Readback Resolution	0.1mA	0.1μA	0.1mA	0.1μA	0.1mA	0.1μA
Readback Accuracy (23±5°C)	1mA	1μA	3mA	1μA	5mA	1μA
Temperature System(0~40°C)	30ppm/°C					
Long-term Stability	100ppm/1000h					
<b>Dynamic Characteristics</b>						
Voltage Rise Time (no load) (10%-90%F.S. Variation Time)	<40μs					
Voltage Rise Time (full load) (10%-90%F.S. Variation Time)	<40μs					

Voltage Fall Time (no load) (90%-10%F.S. Variation Time)	<100μs	
Voltage Fall Time (full load) (90%-10%F.S. Variation Time)	<100μs	
Transient Voltage Drop <sup>1</sup>	350mV	
Transient Recovery Time <sup>2</sup>	<100μs	
Voltage Rise Time (no load) (10%-90%F.S. Variation Time)	100ppm/1000h	
<b>Others</b>		
Load Regulation	0.01%+0.2mV	
Remote Compensation Voltage	≤1V	
Output Terminal Contact Resistance (fault simulation optional)	≤20mΩ(5A 6VDC)	
Isolation (Output to Ground)	1500V DC	
Isolation (Channel to Channel)	500V DC	
Earth Leakage Current	<3.5mA @230V AC	<4mA @230V AC
Communication Response Time	≤10ms	
Interface	LAN/RS232/CAN	
AC Input	Single phase, please refer to the voltage mark at the rear panel.	
Temperature	Operating temperature: 0℃-40℃, storage temperature: -20℃~60℃	
Operating Environment	Altitude <2000m, relative humidity: 5%-90%RH(non-condensing), atmospheric pressure: 80-110kPa	
Dimension (regular)	132.5mm(H)*482.0mm(W)*559.0mm(D)	
Dimension (optional)	132.5mm(H)*482.0mm(W)*559.0mm(D)+ 166.9mm(D)	
Net Weight (regular)	Approx. 17 kg	
Net Weight (optional)	Approx. 20 kg	

**Note 1:** Under full voltage output, the load is changed abruptly from 10% to 90%, and the voltage drop value.

**Note 2:** Under full voltage output, the load is changed abruptly from 10% to 90%, and the voltage is restored to within (original voltage minus 50mV).

This brochure is for reference only, if you need other specifications, please consult REXGEAR for the latest product information. REXGEAR products are constantly updated and technical specifications are subject to change without prior notice.

When multiple BCSs are used in series, the mains power cannot be disconnected when the device channels are ON, all channels must be OFF before disconnecting the mains power, otherwise the device will be damaged!