

**Product**

IT6000C Bidirectional Programmable DC Power Supply

**Bi-directional  
Energy  
Transfer  
Everything Is  
Possible**



# IT6000C Series Bidirectional Programmable DC Power Supply

## APPLICATIONS

- Solar Battery Charger
- Solar Inverter
- Auto Motor
- DC/DC Converter
- Battery Module/Pack
- OBC

*Your Power Testing Solution*

# IT6000C Series

## Bidirectional Programmable DC Power Supply

IT6000C series is a bi-directional programmable DC power supply which adopts the third generation SiC-base technology. It integrates the source and sink function in one unit. Based on these two functions, IT6000C offers the functionality of two-quadrant operation. The regenerative capability enables the energy consumed to be put back onto the grid cleanly, saving costs from energy consumption and cooling, while not interfering with the grid.

IT6000C series provide max. output voltage up to 2250V, support master-slave paralleling with averaging current distribution, max. output power up to 2MW. Built-in waveform generator supports generating arbitrary waveforms, and import LIST files for waveforms via front panel USB port. IT6000C is the combination of high reliability, high efficient setting, safe and multiple measurement functions.



Model	Current	Power	Height	Model	Current	Power	Height	Model	Current	Power	Height
IT6005C-80-150	150A	5kW	3U	IT6006C-300-75	75A	6kW	3U	IT6006C-500-40	40A	6kW	3U
IT6010C-80-300	300A	10kW	3U	IT6012C-300-150	150A	12kW	3U	IT6012C-500-80	80A	12kW	3U
IT6015C-80-450	450A	15kW	3U	IT6018C-300-225	225A	18kW	3U	IT6018C-500-120	120A	18kW	3U
IT6030C-80-900	900A	30kW	6U	IT6036C-300-450	450A	36kW	6U	IT6036C-500-240	240A	36kW	6U
IT6045C-80-1350	1350A	45kW	15U	IT6054C-300-675	675A	54kW	15U	IT6054C-500-360	360A	54kW	15U
IT6060C-80-1800	1800A	60kW	15U	IT6072C-300-900	900A	72kW	15U	IT6072C-500-480	480A	72kW	15U
IT6075C-80-2040	2040A	75kW	27U	IT6090C-300-1125	1125A	90kW	27U	IT6090C-500-600	600A	90kW	27U
IT6090C-80-2040	2040A	90kW	27U	IT6108C-300-1350	1350A	108kW	27U	IT6108C-500-720	720A	108kW	27U
IT6105C-80-2040	2040A	105kW	27U	IT6126C-300-1575	1575A	126kW	27U	IT6126C-500-840	840A	126kW	27U
IT6120C-80-2040	2040A	120kW	27U	IT6144C-300-1800	1800A	144kW	27U	IT6144C-500-960	960A	144kW	27U
IT6135C-80-2040	2040A	135kW	37U	IT6162C-300-2025	2025A	162kW	37U	IT6162C-500-1080	1080A	162kW	37U
IT6150C-80-2040	2040A	150kW	37U	IT6180C-300-2040	2040A	180kW	37U	IT6180C-500-1200	1200A	180kW	37U
IT6165C-80-2040	2040A	165kW	37U	IT6198C-300-2040	2040A	198kW	37U	IT6198C-500-1320	1320A	198kW	37U

Model	Current	Power	Height	Model	Current	Power	Height	Model	Current	Power	Height
IT6006C-800-25	25A	6kW	3U	IT6018C-1500-40	40A	18kW	3U	IT6018C-2250-25	25A	18kW	3U
IT6012C-800-50	50A	12kW	3U	IT6036C-1500-80	80A	36kW	6U	IT6036C-2250-50	50A	36kW	6U
IT6018C-800-75	75A	18kW	3U	IT6054C-1500-120	120A	54kW	15U	IT6054C-2250-75	75A	54kW	15U
IT6036C-800-150	150A	36kW	6U	IT6072C-1500-160	160A	72kW	15U	IT6072C-2250-100	100A	72kW	15U
IT6054C-800-225	225A	54kW	15U	IT6090C-1500-200	200A	90kW	27U	IT6090C-2250-125	125A	90kW	27U
IT6072C-800-300	300A	72kW	15U	IT6108C-1500-240	240A	108kW	27U	IT6108C-2250-150	150A	108kW	27U
IT6090C-800-375	375A	90kW	27U	IT6126C-1500-280	280A	126kW	27U	IT6126C-2250-175	175A	126kW	27U
IT6108C-800-450	450A	108kW	27U	IT6144C-1500-320	320A	144kW	27U	IT6144C-2250-200	200A	144kW	27U
IT6126C-800-525	525A	126kW	27U	IT6162C-1500-360	360A	162kW	37U	IT6162C-2250-225	225A	162kW	37U
IT6144C-800-600	600A	144kW	27U	IT6180C-1500-400	400A	180kW	37U	IT6180C-2250-250	250A	180kW	37U
IT6162C-800-675	675A	162kW	37U	IT6198C-1500-440	440A	198kW	37U	IT6198C-2250-275	275A	198kW	37U
IT6180C-800-750	750A	180kW	37U								
IT6198C-800-825	825A	198kW	37U								

\*This information is subject to change without notice

# Your Power Testing Solution

## IT6000C Bidirectional Programmable DC Power Supply

### Features

- Adopts SiC-base technology, integrates source and sink function in one unit
- High power density up to 18kW in compact 3U rack space, expandable up to 2 MW by paralleling
- Output voltage up to 2250V
- Output current up to 8000A
- Adopts third-generation SiC technology
- Bi-directional power transfer, seamless switch between sourcing and sinking
- High regenerative efficiency up to 95%
- Standard Built-in USB/CAN/LAN/digital IO interface, optional GPIB/analog & RS232
- Full protections: support OVP,  $\pm$ OCP,  $\pm$ OPP, OTP, power down protection, anti-islanding protection
- Support control loop priority mode setting , different loop speed can be set
- Partial pre-compliant with LV123, LV148, DIN40839, ISO-16750-2, SAEJ1113-11, LV124 and ISO21848 testing standards
- Could be used as battery cyclor and support various battery charging and discharging modes, such as CC/CV/CP
- Built-in function generator, support arbitrary-waveform generating
- Could be used as PV simulator, simulating the PV curves (with optional SAS1000 software)
- Support multiple working modes, rising and falling time can be adjustable.
- Support data saving and the shortest interval of sampling is 10 $\mu$ s
- Could be used as battery simulator (with optional BSS2000 Software)
- Strong dynamic driving profile simulation function, up to 10,000,000 points

### Application

01 Renewable Energy		Solar Charger		Micro Inverter	Battery Pack	PV Inverter
02 Automotive	Automotive Motors		Car Charger	Automotive Electronics		Bidirectional DC/DC Converter
03 High-speed testing	Telecom	Power semiconductor components	High speed electronic test		LED products	Civil aviation
04 High-power testing		UPS	Electric motor/generator	Consumer products	Electro plating/welding	ATE systems

### Bi-directional energy, seamless transfer

The IT6000C Series combines source and sink functions in one. Unlike traditional power supplies and E-loads, for which there will be short transitions and inconsistencies in the middle of positive and negative current switching, IT6000C is a standard high-speed bidirectional power supply, enables high-speed source and sink current fast and continuous seamless switching, effectively avoiding voltage or current overshoot, and can be widely used in Energy storage device test, like batteries, cell packaging equipment and battery protection board testing .

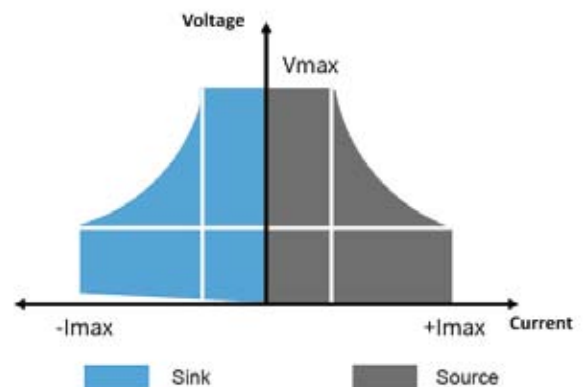



# Your Power Testing Solution

## IT6000C Bidirectional Programmable DC Power Supply

### Power regenerative and eco-friendly

With the power regeneration function, IT6000C can feed back up to 95% power instead of consuming it as heat. It not only save your cost of electricity, HVAC and cooling infrastructure, but also help to reduce carbon emission and impact on the environment.

**Production facility :** 24Hr/day x 7 work days x 52 weeks

Power	electricity cost saved (appr. USD/year)	CO <sub>2</sub> emission reduced (appr. ton/year)
18kW	20,914	149
36kW	41,828	298
90kW	104,570	745
108kW	125,484	894
144kW	167,312	1,191

**R&D lab :** 8Hr/day x 5 work days x 52 weeks

Power	electricity cost saved (appr. USD/year)	CO <sub>2</sub> emission reduced (appr. ton/year)
18kW	4,980	35
36kW	9,959	71
90kW	24,898	177
108kW	29,877	213
144kW	39,836	284

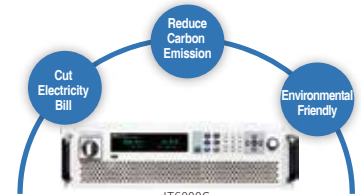

Highly regenerative 95%

\* The data is based on :

1. approximate electricity price 0.14USD/kWh for industry facility in California
2. 1kWh power consumption ≈ 0.997 CO<sub>2</sub> emission

\* The extra cost of air conditioning is not included.

### Application for solar array simulation

IT6000C configured with optional ITECH SAS1000 Solar Array Simulation Software, users can easily use the software to output, measure, display the MPP tracking status of photovoltaic inverter in real time simulation and record value. Built-in EN50530、Sandia、NB/T32004、CGC/GF004、CGC/GF035 standard testing procedures, it is convenient for users to test the static and dynamic MPPT performance of PV inverters and generate reports. Solar simulation power supply also provides the shadow and table mode operation, the user can enter up to 4096 points array to edit any shielded IV curve to achieve dynamic shadow effect simulation and also can store 100 I-V curves under different irradiation and temperature to test the long-term maximum power tracking performance of photovoltaic inverters under different climatic conditions.

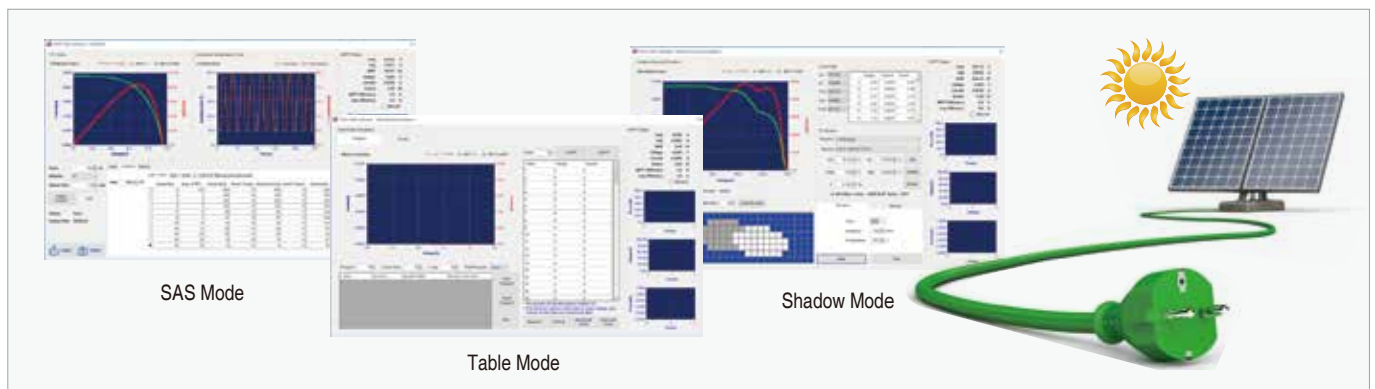

### Built-in voltage curves for a variety of standard automotive voltage curves

Automotive electronics may often encounter power transients during vehicle start-up and operation. To ensure that the device under test can withstand these actual transients, the tester must simulate worst-case power transient conditions during the test. According to the relevant standards of the industry, the IT6000B has built in partial voltage curves LV123, LV148, DIN40839, ISO-16750-2, SAEJ1113-11, LV124 and ISO21848. The User can directly recall the vehicle's starting voltage drop, various automotive electronic tests, pulse waveforms and other related automotive electronics for performance tests. Available voltage grades in 12V, 24V and 48V voltage levels.

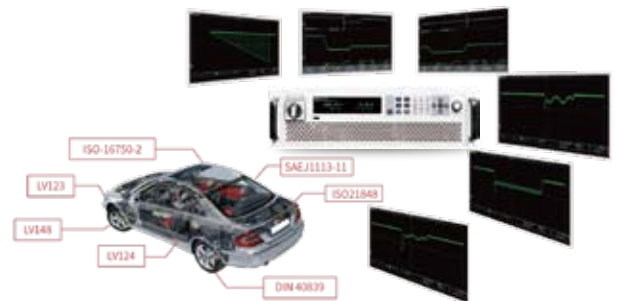

### Control loop CC/CV priority mode

IT6000 C series continues to adopt ITECH-developed innovative CV & CC priority concept, which will help customers effectively and flexibly solve their various tough problems in test applications request for high speed and no over-shoot power supplies. Customers can select CV or CC priority to adjust the speed of the loop circuit, to decide output with the high-speed voltage or current with no overshoot. It is applicable for high-power integrated circuit test, charging/ discharging test and the transient simulation/ characteristic test of automotive electronics.



**Control loop CV priority mode**

After setting the high-speed voltage mode, the voltage output faster and bring with an inrush current which is higher than the current range.



**Control loop CC priority mode**

battery charging and discharging, high speed seamless switch, effectively suppress the current overshoot.

### Parallel connection

#### Advantages:

- Optical fiber transfer between master and slave, guarantee perfect performance of anti-interference
- The parameters will not change after parallel connection
- Adopt Optical fiber isolation technology, effective protection of the device and DUT
- Calibration is not requested after parallel connection

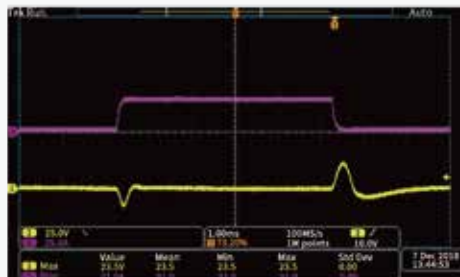

**Stand-alone unit**

Stand-alone unit: IT6006C-500-40 500V 40A 6000W

Input voltage:100V Input current:28A Sinking current :30A

\* Yellow waveform: output voltage Violet waveform: output current

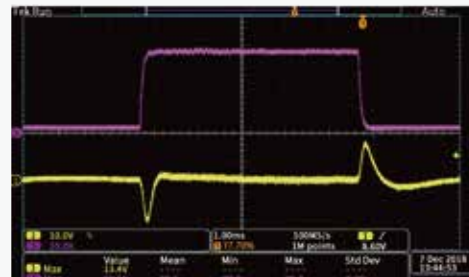

**Paralleled units**

2 sets IT6006C-500-40 paralleled

Input voltage:100V Input current:56A Sinking current :60A



#### From the above waveforms comparison:

we can see the paralleled IT6000C can output the same dynamic response waveform as the original single unit does, and show no-delay fast synchronized response.

**Falling speed**

No substantial changes comparing with single unit after parallel connection

**Rising speed**

Even faster rising speed, comparing with single unit after parallel connection

**Dynamic response waveform**

consistent with single unit waveform after parallel connection

# Your Power Testing Solution

## IT6000C Bidirectional Programmable DC Power Supply

### Multiple interfaces

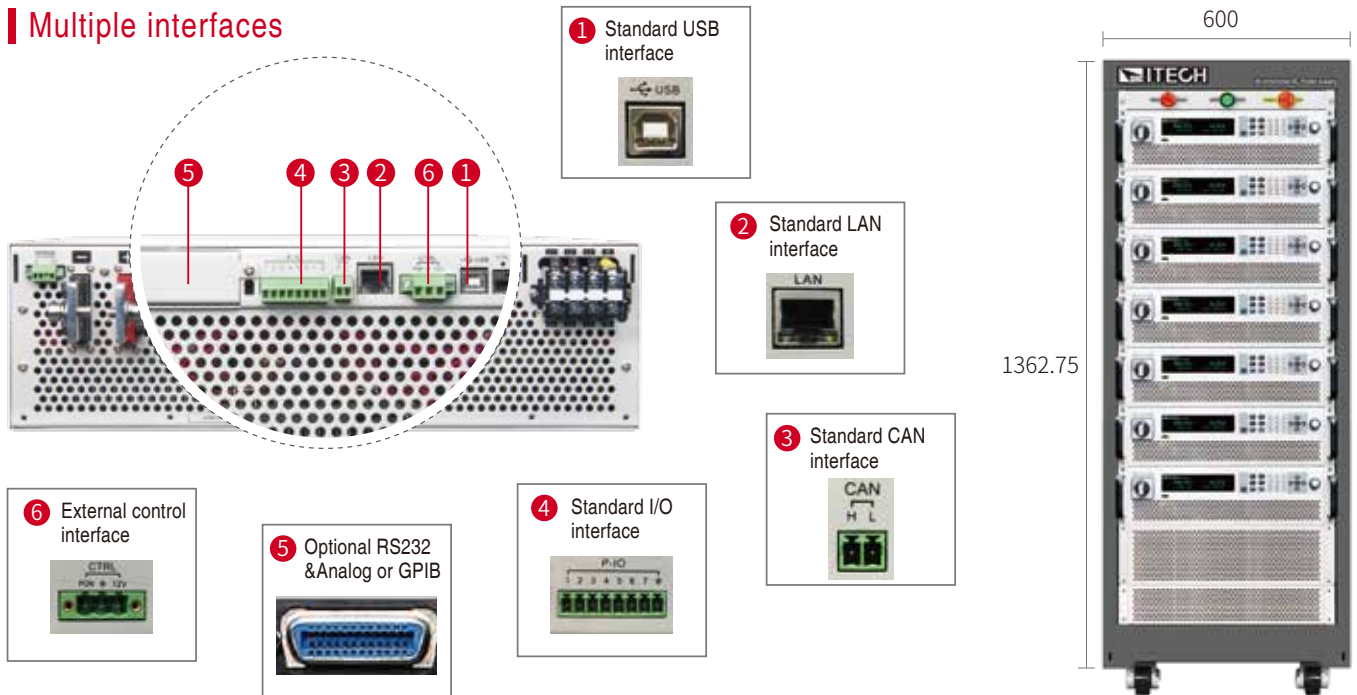

Category	Model	Specification	Description
Accessories for parallel connection	15U rack *	15u cabinet(optional emergency stop)	907.6mmH*800mmD*550mmW
	27U rack *	27u cabinet(optional emergency stop)	1362.75mmH*800mmD*600mmW
	37U rack *	37u cabinet(optional emergency stop)	1764.35mmH*800mmD*600mmW
	IT-E168	optical fiber kit for parallel connection	for parallel communication between single units
	IT-E169	Optical fiber kit for parallel connection	for parallel communication between cabinets
Anti-reverse protection unit	IT-E165A-250	750V/250A	Reverse polarity protection
	IT-E165A-400	750V/400A	Reverse polarity protection
	IT-E165A-500	900V/400A	Reverse polarity protection
	IT-E165B	Anti electromotive force protection unit	Avoid current back flow
Other accessories	IT-E258-15U IT-E258E-15U IT-E258U-15U	5m power cord for 15U unit	Applied for Europe (-E) or United States (-U) or other area
	IT-E258-27U IT-E258E-27U IT-E258U-27U	5m power cord for 27U unit	Applied for Europe (-E) or United States (-U) or other area
	IT-E258-37U IT-E258E-37U IT-E258U-37U	5m power cord for 37U unit	Applied for Europe (-E) or United States (-U) or other area
	IT-E166	GPIB communication card	
	IT-E167	RS232 & analog interface card	
	Test software	BSS2000	Battery simulation software
SAS1000		Solar array simulation software	SAS1000L (<15kW) / SAS1000 / Multi-channel SAS1000M
FCS3000		Fuel cell simulation software	FCS3000

\* Contact us for details

# Testing Solution

## IT6000C Bidirectional Programmable DC Power Supply

### Specification

	IT6005C-80-150	IT6010C-80-300	IT6015C-80-450	
Rated Value Range (0°C~50°C)	Voltage	0~80V	0~80V	0~80V
	Current	-150~150A	-300~300A	-450~450A
	Power	-5000~5000W	-10000~10000W	-15000~15000W
	Resistance	0~0.533Ω	0~0.267Ω	0~0.178Ω
Power Regulation ±(% of Offset)	Voltage	≤0.01%FS	≤0.01%FS	≤0.01%FS
	Current	≤0.05%FS	≤0.05%FS	≤0.05%FS
Load Regulation ±(% of Offset)	Voltage	≤0.02%FS	≤0.02%FS	≤0.02%FS
	Current	≤0.05%FS	≤0.05%FS	≤0.05%FS
Setup Resolution	Voltage	0.001V	0.001V	0.001V
	Current	0.01A	0.01A	0.01A
	Power	0.001kW	0.001kW	0.001kW
	Resistance	0.001Ω	0.001Ω	0.001Ω
Readback Resolution	Voltage	0.001V	0.001V	0.001V
	Current	0.01A	0.01A	0.01A
	Power	0.001kW	0.001kW	0.001kW
	Resistance	0.001Ω	0.001Ω	0.001Ω
Setting Accuracy within 12 mons 25°±5° ±( % of Output +Offset )	Voltage	≤0.02%+0.02%FS	≤0.02% +0.02%FS	≤0.02% + 0.02%FS
	Current	≤0.1%+0.1%FS	≤0.1% + 0.1%FS	≤0.1% + 0.1%FS
	Power	≤0.5%+0.5%FS	≤0.5% + 0.5%FS	≤0.5% + 0.5%FS
	Resistance	≤1% + 1%FS	≤1% + 1%FS	≤1% + 1%FS
Readback Accuracy within 12 mons 25°±5° ±( % of Output +Offset )	Voltage	≤0.02%+0.02%FS	≤0.02% +0.02%FS	≤0.02% + 0.02%FS
	Current	≤0.1%+0.1%FS	≤0.1% + 0.1%FS	≤0.1% + 0.1%FS
	Power	≤0.5%+0.5%FS	≤0.5% + 0.5%FS	≤0.5% + 0.5%FS
	Resistance	≤1% + 1%FS	≤1% + 1%FS	≤1% + 1%FS
Ripple (20Hz -20MHz)	Voltage	≤120mVpp(MAX: ≤200mVpp)	≤120mVpp(MAX: ≤200mVpp)	≤120mVpp(MAX: ≤200mVpp)
	Current	≤0.1%FS RMS	≤0.1%FS RMS	≤0.1%FS RMS
Setting Temperature Coefficient (% of Offset/°C)	Voltage	≤50PPM/°C	≤50PPM/°C	≤50PPM/°C
	Current	≤200PPM/°C	≤200PPM/°C	≤200PPM/°C
Readback Temperature Coefficient (% of Offset/°C)	Voltage	≤50PPM/°C	≤50PPM/°C	≤50PPM/°C
	Current	≤200PPM/°C	≤200PPM/°C	≤200PPM/°C
Rising Time (no load)	Voltage	≤15ms	≤15ms	≤15ms
Rising Time (full load)	Voltage	≤30ms	≤30ms	≤30ms
Falling Time (no load)	Voltage	≤30ms	≤30ms	≤30ms
Falling Time (full load)	Voltage	≤15ms	≤15ms	≤15ms
Transient Response Time	Voltage	≤2ms	≤2ms	≤2ms
AC Input	Voltage	198V~264V (Decrease 50%) 342V~528V {3PH + PE (no neutral)}		
	Frequency	47Hz~63Hz	47Hz~63Hz	47Hz~63Hz
Setup Stability-30min ( % of Output +Offset)	Voltage	≤0.02%+0.02%FS	≤0.02%+0.02%FS	≤0.02% + 0.02%FS
	Current	≤0.1%+0.1%FS	≤0.1% + 0.1%FS	≤0.1% + 0.1%FS
Setup Stability-8h ( % of Output +Offset)	Voltage	≤0.02%+0.02%FS	≤0.02%+0.02%FS	≤0.02% + 0.02%FS
	Current	≤0.1%+0.1%FS	≤0.1% + 0.1%FS	≤0.1% + 0.1%FS
Readback Stability-30min ( % of Output +Offset)	Voltage	≤0.02%+0.02%FS	≤0.02%+0.02%FS	≤0.02% + 0.02%FS
	Current	≤0.1%+0.1%FS	≤0.1% + 0.1%FS	≤0.1% + 0.1%FS
Readback Stability-8h ( % of Output +Offset)	Voltage	≤0.02%+0.02%FS	≤0.02%+0.02%FS	≤0.02% + 0.02%FS
	Current	≤0.1%+0.1%FS	≤0.1% + 0.1%FS	≤0.1% + 0.1%FS
Efficiency		~90%	~90%	~90%
Remote Sense Compensation Voltage		≤5V	≤5V	≤5V
Command Response Time		2mS	2mS	2mS
Power Factor		0.99	0.99	0.99
Maximum Input Current		L1,L2/17A;L3/0A	L1,L2/17A;L3/29A	28.42A
Maximum Input Apparent Power		5.7kVA	11.3kVA	16.9kVA
Storage Tem.		-10°C~70°C	-10°C~70°C	-10°C~70°C
Working Tem.		0~50°C	0~50°C	0~50°C
Net. Dimension (mm)		483W*801.61D*151.3H	483W*801.61D*151.3H	483W*801.61D*151.3H
Net. Weight		20KG	30KG	40KG

\*This information is subject to change without notice.

# Your Power Testing Solution

## IT6000C Bidirectional Programmable DC Power Supply

### Specification

		IT6006C-300-75	IT6012C-300-150	IT6018C-300-225
Rated Value Range (0°C~50°C)	Voltage	0~300V	0~300V	0~300V
	Current	-75~75A	-150~150A	-225~225A
	Power	-6000~6000W	-12000~12000W	-18000~18000W
	Resistance	0~1Ω	0~1Ω	0~1Ω
Power Regulation ±(% of Offset)	Voltage	≤0.01%FS	≤0.01%FS	≤0.01%FS
	Current	≤0.05%FS	≤0.05%FS	≤0.05%FS
Load Regulation ±(% of Offset)	Voltage	≤0.02%FS	≤0.02%FS	≤0.02%FS
	Current	≤0.05%FS	≤0.05%FS	≤0.05%FS
Setup Resolution	Voltage	0.01V	0.01V	0.01V
	Current	0.01A	0.01A	0.01A
	Power	0.001kW	0.001kW	0.001kW
	Resistance	0.01Ω	0.001Ω	0.001Ω
Readback Resolution	Voltage	0.01V	0.01V	0.01V
	Current	0.01A	0.01A	0.01A
	Power	0.001kW	0.001kW	0.001kW
	Resistance	0.01Ω	0.001Ω	0.001Ω
Setting Accuracy within 12 mons 25°±5° ±(% of Output +Offset)	Voltage	≤0.02% + 0.02%FS	≤0.02% + 0.02%FS	≤0.02% + 0.02%FS
	Current	≤0.1% + 0.1%FS	≤0.1% + 0.1%FS	≤0.1% + 0.1%FS
	Power	≤0.5% + 0.5%FS	≤0.5% + 0.5%FS	≤0.5% + 0.5%FS
	Resistance	≤1% + 1%FS	≤1% + 1%FS	≤1% + 1%FS
Readback Accuracy within 12 mons 25°±5° ±(% of Output +Offset)	Voltage	≤0.02% + 0.02%FS	≤0.02% + 0.02%FS	≤0.02% + 0.02%FS
	Current	≤0.1% + 0.1%FS	≤0.1% + 0.1%FS	≤0.1% + 0.1%FS
	Power	≤0.5% + 0.5%FS	≤0.5% + 0.5%FS	≤0.5% + 0.5%FS
	Resistance	≤1% + 1%FS	≤1% + 1%FS	≤1% + 1%FS
Ripple (20Hz~20MHz)	Voltage	≤120mVpp(MAX: ≤600mVpp)	≤120mVpp(MAX: ≤600mVpp)	≤120mVpp(MAX: ≤300mVpp)
	Current	≤0.1%FS RMS	≤0.1%FS RMS	≤0.1%FS RMS
Setting Temperature Coefficient (% of Offset/°C)	Voltage	≤50PPM/°C	≤50PPM/°C	≤50PPM/°C
	Current	≤200PPM/°C	≤200PPM/°C	≤200PPM/°C
Readback Temperature Coefficient (% of Offset/°C)	Voltage	≤50PPM/°C	≤50PPM/°C	≤50PPM/°C
	Current	≤200PPM/°C	≤200PPM/°C	≤200PPM/°C
Rising Time (no load)	Voltage	≤15ms	≤15ms	≤15ms
Rising Time (full load)	Voltage	≤30ms	≤30ms	≤30ms
Falling Time (no load)	Voltage	≤30ms	≤30ms	≤30ms
Falling Time (full load)	Voltage	≤15ms	≤15ms	≤15ms
Transient Response Time	Voltage	≤2ms	≤2ms	≤2ms
AC Input	Voltage	198V~264V (Decrease 50%) 342V~528V {3PH + PE (no neutral)}		
	Frequency	47Hz~63Hz	47Hz~63Hz	47Hz~63Hz
Setup Stability-30min (% of Output +Offset)	Voltage	≤0.02%+0.02%FS	≤0.02%+0.02%FS	≤0.02%+0.02%FS
	Current	≤0.1% + 0.1%FS	≤0.1% + 0.1%FS	≤0.1% + 0.1%FS
Setup Stability-8h (% of Output +Offset)	Voltage	≤0.02%+0.02%FS	≤0.02%+0.02%FS	≤0.02%+0.02%FS
	Current	≤0.1% + 0.1%FS	≤0.1% + 0.1%FS	≤0.1% + 0.1%FS
Readback Stability-30min (% of Output +Offset)	Voltage	≤0.02%+0.02%FS	≤0.02%+0.02%FS	≤0.02%+0.02%FS
	Current	≤0.1% + 0.1%FS	≤0.1% + 0.1%FS	≤0.1% + 0.1%FS
Readback Stability-8h (% of Output +Offset)	Voltage	≤0.02%+0.02%FS	≤0.02%+0.02%FS	≤0.02%+0.02%FS
	Current	≤0.1% + 0.1%FS	≤0.1% + 0.1%FS	≤0.1% + 0.1%FS
Efficiency		~92%	~92%	~92%
Remote Sense Compensation Voltage		≤5V	≤5V	≤5V
Command Response Time		2mS	2mS	2mS
Power Factor		0.99	0.99	0.99
Maximum Input Current		L1,L2/20A;L3/0A	L1,L2/20A;L3/34A	33.37A
Maximum Input Apparent Power		6.6kVA	13.2kVA	19.8kVA
Storage Tem.		-10°C~70°C	-10°C~70°C	-10°C~70°C
Working Tem.		0~50°C	0~50°C	0~50°C
Net. Dimension (mm)		483W*801.61D*151.3H	483W*801.61D*151.3H	483W*801.61D*151.3H
Net. Weight		20KG	30KG	40KG

\*This information is subject to change without notice.



# Testing Solution

## IT6000C Bidirectional Programmable DC Power Supply

### Specification

	IT6006C-500-40	IT6012C-500-80	IT6018C-500-120	
Rated Value Range (0°C~50°C)	Voltage	0~500V	0~500V	0~500V
	Current	-40~40A	-80~80A	-120~120A
	Power	-6000~6000W	-12000~12000W	-18000~18000W
	Resistance	0~1Ω	0~1Ω	0~1Ω
Power Regulation ±(% of Offset)	Voltage	≤0.01%FS	≤0.01%FS	≤0.01%FS
	Current	≤0.05%FS	≤0.05%FS	≤0.05%FS
Load Regulation ±(% of Offset)	Voltage	≤0.02%FS	≤0.02%FS	≤0.02%FS
	Current	≤0.05%FS	≤0.05%FS	≤0.05%FS
Setup Resolution	Voltage	0.01V	0.01V	0.01V
	Current	0.001A	0.01A	0.01A
	Power	0.001kW	0.001kW	0.001kW
	Resistance	0.01Ω	0.01Ω	0.01Ω
Readback Resolution	Voltage	0.01V	0.01V	0.01V
	Current	0.001A	0.01A	0.01A
	Power	0.001kW	0.001kW	0.001kW
	Resistance	0.01Ω	0.01Ω	0.01Ω
Setting Accuracy within 12 mons 25°±5° ±(% of Output +Offset)	Voltage	≤0.02% + 0.02%FS	≤0.02% + 0.02%FS	≤0.02% + 0.02%FS
	Current	≤0.1% + 0.1%FS	≤0.1% + 0.1%FS	≤0.1% + 0.1%FS
	Power	≤0.5% + 0.5%FS	≤0.5% + 0.5%FS	≤0.5% + 0.5%FS
	Resistance	≤1% + 1%FS	≤1% + 1%FS	≤1% + 1%FS
Readback Accuracy within 12 mons 25°±5° ±(% of Output +Offset)	Voltage	≤0.02% + 0.02%FS	≤0.02% + 0.02%FS	≤0.02% + 0.02%FS
	Current	≤0.1% + 0.1%FS	≤0.1% + 0.1%FS	≤0.1% + 0.1%FS
	Power	≤0.5% + 0.5%FS	≤0.5% + 0.5%FS	≤0.5% + 0.5%FS
	Resistance	≤1% + 1%FS	≤1% + 1%FS	≤1% + 1%FS
Ripple (20Hz~20MHz)	Voltage	≤200mVpp(MAX: ≤500mVpp)	≤200mVpp(MAX: ≤500mVpp)	≤200mVpp(MAX:500mVpp)
	Current	≤0.1%FS RMS	≤0.1%FS RMS	≤0.1%FS RMS
Setting Temperature Coefficient (% of Offset/°C)	Voltage	≤50PPM/°C	≤50PPM/°C	≤50PPM/°C
	Current	≤200PPM/°C	≤200PPM/°C	≤200PPM/°C
Readback Temperature Coefficient (% of Offset/°C)	Voltage	≤50PPM/°C	≤50PPM/°C	≤50PPM/°C
	Current	≤200PPM/°C	≤200PPM/°C	≤200PPM/°C
Rising Time (no load)	Voltage	≤15ms	≤15ms	≤15ms
Rising Time (full load)	Voltage	≤30ms	≤30ms	≤30ms
Falling Time (no load)	Voltage	≤30ms	≤30ms	≤30ms
Falling Time (full load)	Voltage	≤15ms	≤15ms	≤15ms
Transient Response Time	Voltage	≤2ms	≤2ms	≤2ms
AC Input	Voltage	198V~264V (Decrease 50%) 342V~528V {3PH + PE (no neutral)}		
	Frequency	47Hz~63Hz	47Hz~63Hz	47Hz~63Hz
Setup Stability-30min (% of Output +Offset)	Voltage	≤0.02%+0.02%FS	≤0.02% + 0.02%FS	≤0.02% + 0.02%FS
	Current	≤0.1% + 0.1%FS	≤0.1% + 0.1%FS	≤0.1% + 0.1%FS
Setup Stability-8h (% of Output +Offset)	Voltage	≤0.02%+0.02%FS	≤0.02% + 0.02%FS	≤0.02% + 0.02%FS
	Current	≤0.1% + 0.1%FS	≤0.1% + 0.1%FS	≤0.1% + 0.1%FS
Readback Stability-30min (% of Output +Offset)	Voltage	≤0.02%+0.02%FS	≤0.02% + 0.02%FS	≤0.02% + 0.02%FS
	Current	≤0.1% + 0.1%FS	≤0.1% + 0.1%FS	≤0.1% + 0.1%FS
Readback Stability-8h (% of Output +Offset)	Voltage	≤0.02%+0.02%FS	≤0.02% + 0.02%FS	≤0.02% + 0.02%FS
	Current	≤0.1% + 0.1%FS	≤0.1% + 0.1%FS	≤0.1% + 0.1%FS
Efficiency		~92%	~92%	~92%
Remote Sense Compensation Voltage		≤5V	≤5V	≤5V
Command Response Time		2mS	2mS	2mS
Power Factor		0.99	0.99	0.99
Maximum Input Current		L1,I2/20A;L3/0A	L1,I2/20A;L3/34A	33.37A
Maximum Input Apparent Power		6.6kVA	13.2kVA	19.8kVA
Storage Tem.		-10°C~70°C	-10°C~70°C	-10°C~70°C
Working Tem.		0~50°C	0~50°C	0~50°C
Net. Dimension (mm)		483W*801.61D*151.3H	483W*801.61D*151.3H	483W*801.61D*151.3H
Net. Weight		20KG	30KG	40KG

\*This information is subject to change without notice.

# Your Power Testing Solution

## IT6000C Bidirectional Programmable DC Power Supply

	IT6006C-800-25	IT6012C-800-50	IT6018C-800-75	
Rated Value Range (0°C~50°C)	Voltage	0~800V	0~800V	0~800V
	Current	-25~25A	-50~50A	-75~75A
	Power	-6000~6000W	-12000~12000W	-18000~18000W
	Resistance	0~1Ω	0~1Ω	0~1Ω
Power Regulation ±(% of Offset)	Voltage	≤0.01%FS	≤0.01%FS	≤0.01%FS
	Current	≤0.05%FS	≤0.05%FS	≤0.05%FS
Load Regulation ±(% of Offset)	Voltage	≤0.02%FS	≤0.02%FS	≤0.02%FS
	Current	≤0.05%FS	≤0.05%FS	≤0.05%FS
Setup Resolution	Voltage	0.01V	0.01V	0.01V
	Current	0.001A	0.01A	0.01A
	Power	0.001kW	0.001kW	0.001kW
	Resistance	0.1Ω	0.01Ω	0.01Ω
Readback Resolution	Voltage	0.01V	0.01V	0.01V
	Current	0.001A	0.01A	0.01A
	Power	0.001kW	0.001kW	0.001kW
	Resistance	0.1Ω	0.01Ω	0.01Ω
Setting Accuracy within 12 mons 25°±5° ±(% of Output +Offset)	Voltage	≤0.02% + 0.02%FS	≤0.02% + 0.02%FS	≤0.02% + 0.02%FS
	Current	≤0.1% + 0.1%FS	≤0.1% + 0.1%FS	≤0.1% + 0.1%FS
	Power	≤0.5% + 0.5%FS	≤0.5% + 0.5%FS	≤0.5% + 0.5%FS
	Resistance	≤1% + 1%FS	≤1% + 1%FS	≤1% + 1%FS
Readback Accuracy within 12 mons 25°±5° ±(% of Output +Offset)	Voltage	≤0.02% + 0.02%FS	≤0.02% + 0.02%FS	≤0.02% + 0.02%FS
	Current	≤0.1% + 0.1%FS	≤0.1% + 0.1%FS	≤0.1% + 0.1%FS
	Power	≤0.5% + 0.5%FS	≤0.5% + 0.5%FS	≤0.5% + 0.5%FS
	Resistance	≤1% + 1%FS	≤1% + 1%FS	≤1% + 1%FS
Ripple (20Hz -20MHz)	Voltage	≤800mVpp(MAX: ≤1.2Vpp)	≤800mVpp(MAX: ≤1.2Vpp)	≤320mVpp(MAX: ≤800mVpp)
	Current	≤0.1%FS RMS	≤0.1%FS RMS	≤0.1%FS RMS
Setting Temperature Coefficient (% of Offset/°C)	Voltage	≤50PPM/°C	≤50PPM/°C	≤50PPM/°C
	Current	≤200PPM/°C	≤200PPM/°C	≤200PPM/°C
Readback Temperature Coefficient (% of Offset/°C)	Voltage	≤50PPM/°C	≤50PPM/°C	≤50PPM/°C
	Current	≤200PPM/°C	≤200PPM/°C	≤200PPM/°C
Rising Time (no load)	Voltage	≤15ms	≤15ms	≤15ms
Rising Time (full load)	Voltage	≤30ms	≤30ms	≤30ms
Falling Time (no load)	Voltage	≤30ms	≤30ms	≤30ms
Falling Time (full load)	Voltage	≤15ms	≤15ms	≤15ms
Transient Response Time	Voltage	≤2ms	≤2ms	≤2ms
AC Input	Voltage	198V~264V (Decrease 50%) 342V~528V {3PH + PE (no neutral)}		
	Frequency	47Hz~63Hz	47Hz~63Hz	47Hz~63Hz
Setup Stability-30min (% of Output +Offset)	Voltage	≤0.02%+0.02%FS	≤0.02% + 0.02%FS	≤0.02% + 0.02%FS
	Current	≤0.1% + 0.1%FS	≤0.1% + 0.1%FS	≤0.1% + 0.1%FS
Setup Stability-8h (% of Output +Offset)	Voltage	≤0.02%+0.02%FS	≤0.02% + 0.02%FS	≤0.02% + 0.02%FS
	Current	≤0.1% + 0.1%FS	≤0.1% + 0.1%FS	≤0.1% + 0.1%FS
Readback Stability-30min (% of Output +Offset)	Voltage	≤0.02%+0.02%FS	≤0.02% + 0.02%FS	≤0.02% + 0.02%FS
	Current	≤0.1% + 0.1%FS	≤0.1% + 0.1%FS	≤0.1% + 0.1%FS
Readback Stability-8h (% of Output +Offset)	Voltage	≤0.02%+0.02%FS	≤0.02% + 0.02%FS	≤0.02% + 0.02%FS
	Current	≤0.1% + 0.1%FS	≤0.1% + 0.1%FS	≤0.1% + 0.1%FS
Efficiency		~92%	~92%	~92%
Remote Sense Compensation Voltage		≤8V	≤8V	≤8V
Command Response Time		2mS	2mS	2mS
Power Factor		0.99	0.99	0.99
Maximum Input Current		L1,L2/20A;L3/0A	L1,L2/20A;L3/34A	33.37A
Maximum Input Apparent Power		6.6kVA	13.2kVA	19.8kVA
Storage Tem.		-10°C~70°C	-10°C~70°C	-10°C~70°C
Working Tem.		0~50°C	0~50°C	0~50°C
Net. Dimension (mm)		483W*801.61D*151.3H	483W*801.61D*151.3H	483W*801.61D*151.3H
Net. Weight		20KG	30KG	40kg

\*This information is subject to change without notice.

# Testing Solution

## IT6000C Bidirectional Programmable DC Power Supply

	IT6018C-1500-40	IT6018C-2250-25	
Rated Value Range (0 °C-50 °C)	Voltage	0~1500V	0~2250V
	Current	-40~40A	-25~25A
	Power	-18000~18000W	-18000~18000W
	Resistance	0~1Ω	0~1Ω
Power Regulation ±(% of Offset)	Voltage	≤0.01%FS	≤0.01%FS
	Current	≤0.05%FS	≤0.05%FS
Load Regulation ±(% of Offset)	Voltage	≤0.02%FS	≤0.02%FS
	Current	≤0.05%FS	≤0.05%FS
Setup Resolution	Voltage	0.1V	0.1V
	Current	0.001A	0.001A
	Power	0.001kW	0.001kW
	Resistance	0.1Ω	0.1Ω
Readback Resolution	Voltage	0.1V	0.1V
	Current	0.001A	0.001A
	Power	0.001kW	0.001kW
	Resistance	0.1Ω	0.1Ω
Setting Accuracy within 12 mons 25°±5° ±( % of Output +Offset )	Voltage	≤0.02% + 0.02%FS	≤0.02% + 0.02%FS
	Current	≤0.1% + 0.1%FS	≤0.1% + 0.1%FS
	Power	≤0.5% + 0.5%FS	≤0.5% + 0.5%FS
	Resistance	≤1% + 1%FS	≤1% + 1%FS
Readback Accuracy within 12 mons 25°±5° ±( % of Output +Offset )	Voltage	≤0.02% + 0.02%FS	≤0.02% + 0.02%FS
	Current	≤0.1% + 0.1%FS	≤0.1% + 0.1%FS
	Power	≤0.5% + 0.5%FS	≤0.5% + 0.5%FS
	Resistance	≤1% + 1%FS	≤1% + 1%FS
Ripple (20Hz -20MHz)	Voltage	≤600mVpp(MAX: ≤1500mVpp)	≤900mVpp(MAX: ≤2250mVpp)
	Current	≤0.1%FS RMS	≤0.1%FS RMS
Setting Temperature Coefficient (% of Offset/ °C)	Voltage	≤50PPM/°C	≤50PPM/°C
	Current	≤200PPM/°C	≤200PPM/°C
Readback Temperature Coefficient (% of Offset/ °C)	Voltage	≤50PPM/°C	≤50PPM/°C
	Current	≤200PPM/°C	≤200PPM/°C
Rising Time (no load)	Voltage	≤15ms	≤15ms
Rising Time (full load)	Voltage	≤30ms	≤30ms
Falling Time (no load)	Voltage	≤30ms	≤30ms
Falling Time (full load)	Voltage	≤15ms	≤15ms
Transient Response Time	Voltage	≤2ms	≤2ms
AC Input	Voltage	198V~264V (Decrease 50%) 342V~528V {3PH + PE (no neutral)}	198V~264V (Decrease 50%) 342V~528V {3PH + PE (no neutral)}
	Frequency	47Hz~63Hz	47Hz~63Hz
Setup Stability-30min ( % of Output +Offset)	Voltage	≤0.02% + 0.02%FS	≤0.02% + 0.02%FS
	Current	≤0.1% + 0.1%FS	≤0.1% + 0.1%FS
Setup Stability-8h ( % of Output +Offset)	Voltage	≤0.02% + 0.02%FS	≤0.02% + 0.02%FS
	Current	≤0.1% + 0.1%FS	≤0.1% + 0.1%FS
Readback Stability-30min ( % of Output +Offset)	Voltage	≤0.02% + 0.02%FS	≤0.02% + 0.02%FS
	Current	≤0.1% + 0.1%FS	≤0.1% + 0.1%FS
Readback Stability-8h ( % of Output +Offset)	Voltage	≤0.02% + 0.02%FS	≤0.02% + 0.02%FS
	Current	≤0.1% + 0.1%FS	≤0.1% + 0.1%FS
Efficiency		~92%	~92%
Remote Sense Compensation Voltage		≤15V	≤22.5V
Command Response Time		2mS	2mS
Power Factor		0.99	0.99
Maximum Input Current		33.37A	33.37A
Maximum Input Apparent Power		19.8kVA	19.8kVA
Storage Tem.		-10°C~70°C	-10°C~70°C
Working Tem.		0~50°C	0~50°C
Net. Dimension (mm)		483W*801.61D*151.3H	483W*801.61D*151.3H
Net. Weight		40KG	40KG

\*This information is subject to change without notice.

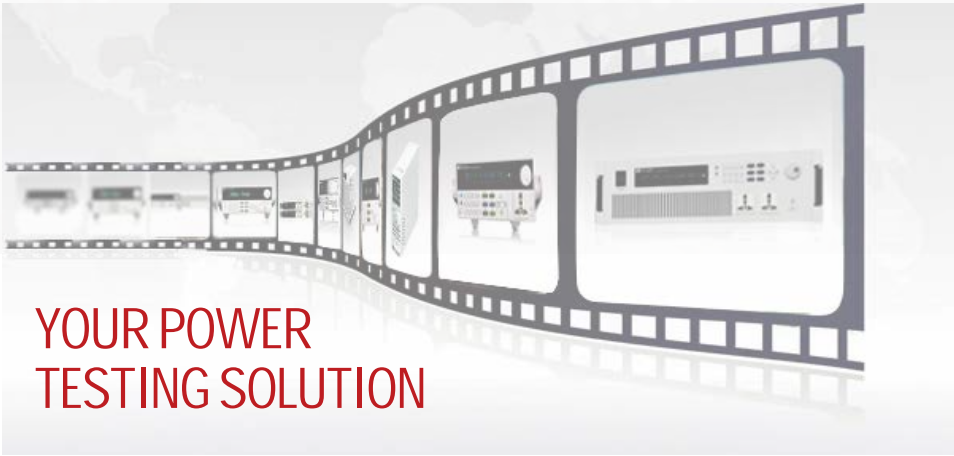
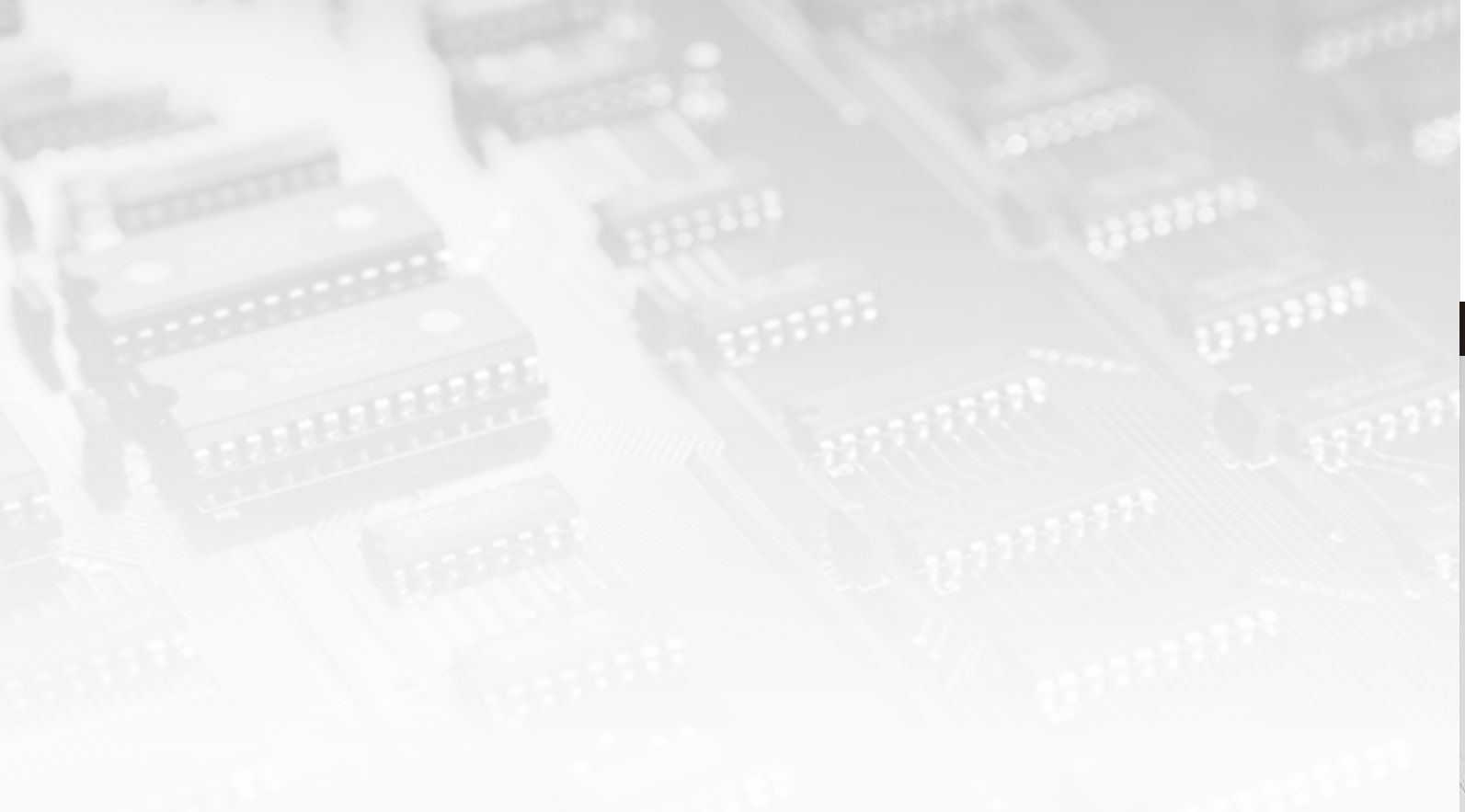

This information is subject to change without notice. For more information, please contact ITECH.

## Taipei

Add: No.918, Zhongzheng Rd., Zhonghe Dist., New Taipei City  
235, Taiwan

Web: [www.itechate.com](http://www.itechate.com)

TEL: +886-3-6684333

E-mail: [info@itechate.com](mailto:info@itechate.com)

## Factory I

Add: No.108, XiShanqiao Nanlu, Nanjing city, 210039, China

TEL: +86-25-52415098

Web: [www.itechate.com](http://www.itechate.com)

## Factory II

Add: No.150, Yaonanlu, Meishan Cun, Nanjing city, 210039, China

TEL: +86-25-52415099

Web: [www.itechate.com](http://www.itechate.com)



ITECH Web



ITECH Facebook



ITECH LinkedIn