



GAZEBO PENGUIN INC.

4660 Hickmore, St-Laurent
Quebec, Canada H4T 1K2

1-800-737-7174 / 514-276-3485

Fax : 1-514-276-4147

customerservice@gazebopenguin.com

**PLEASE READ
IN ITS ENTIRETY
BEFORE
INSTALLATION**

W1207

8 X 12 SOLARIUM

**PLEASE READ
IN ITS ENTIRETY
BEFORE
INSTALLATION**

ASSEMBLY INSTRUCTIONS

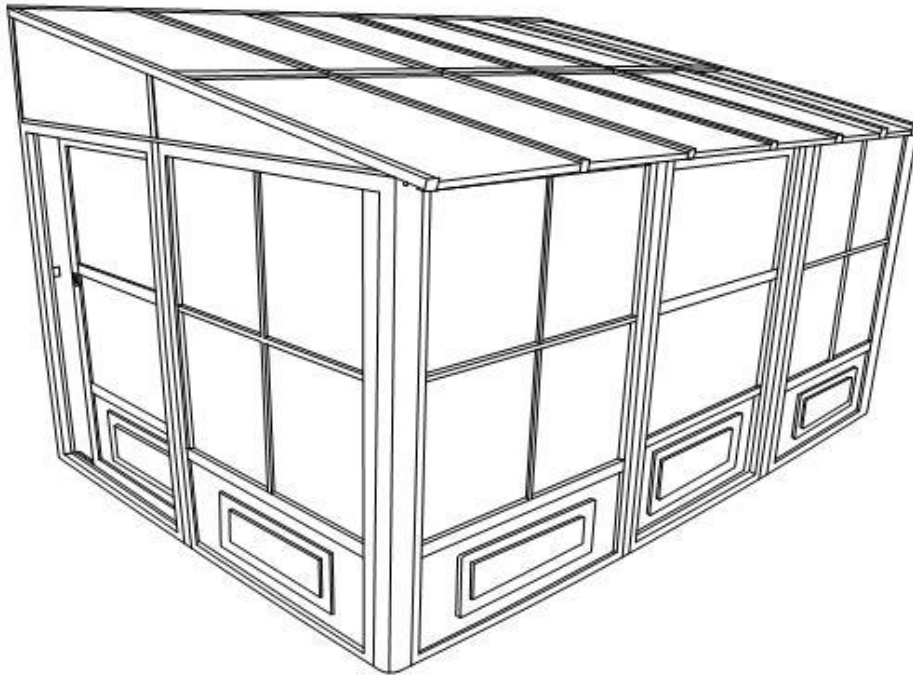

DO NOT DESTROY THE BOXES UNTIL COMPLETELY ASSEMBLED

PLEASE VERIFY THE CONTENT OF EACH BOX AGAINST THE LIST OF PARTS

Assembly by two or three adults is suggested.

Requires 96" clearance at the wall

Base Dimensions 144"x 94 1/2", Largest Dimensions 144"x98 1/2" (see pg.12)

TOOLS REQUIRED:

- Screwdriver (Phillips #2)
- Knife
- File (smooth)
- Needle-nosed pliers
- Rubber mallet
- Step ladder (minimum 6' in height)
- Spatula
- Power drill
- Tube of silicon
- Drill bit 5/16" cement
(according to surface)

BEFORE STARTING:

Ensure that you have a solid base, such as concrete or wooden deck, not slanted more than 1" per 8'. Avoid installing unit adjacent to trees or a sloped roof, as snow and ice may slide onto the solarium and cause it to collapse. Please don't destroy boxes until completely assembled.

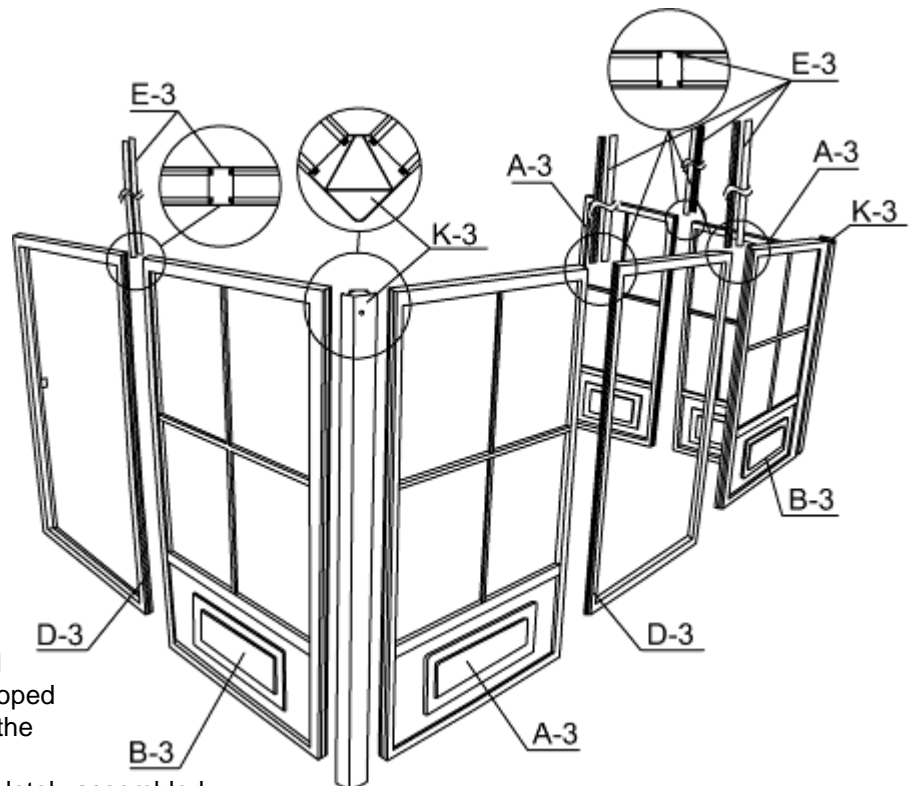

STEP #1

Decide the position of the door frames before assembly according to where you intend to slide the door. At the front of the solarium, use frame D3 for the opening of the door and B3 for the direction of the door when open. Use E3 between frame ends and use two (2) K3 joints for corners.

NOTE:

When placing the door frame opening, make sure the inserts on the frame are on the inside and on the upper half of the frame of the solarium because the door will be set on the inside due to clearance.

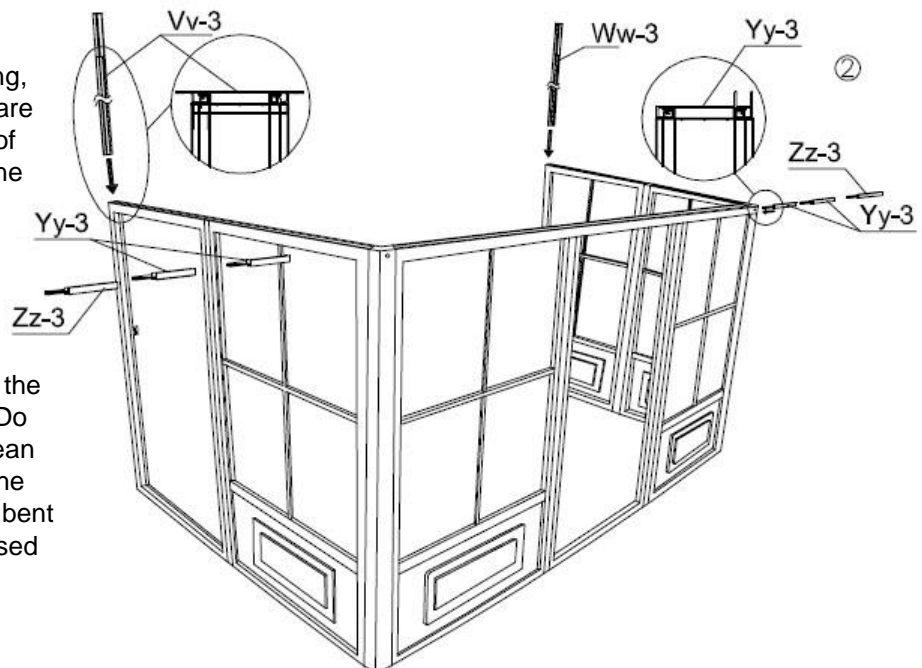

NOTE:

When sliding the connectors, shake the frame so that they will slide easily. Do not use tools to force. If needed, clean the paint with a file and make sure the ends of the frame and joints are not bent or warped. If so, use the needle-nosed pliers to straighten.

STEP #2

Slide the vertical guides Vv-3 left and Ww-3 right into the 2 ends of the frames along the grooves, shaking while sliding for easier movement. Next, slide two (2) Yy-3 and one (1) Zz-3 from left side to right on top of the frame. The groove should be towards the interior of the unit. Repeat from right side with two (2) Yy-3 and one (1) Zz-3 and space evenly.

ASSEMBLE PIECES BEFORE SCREWING THEM TO THE WALL

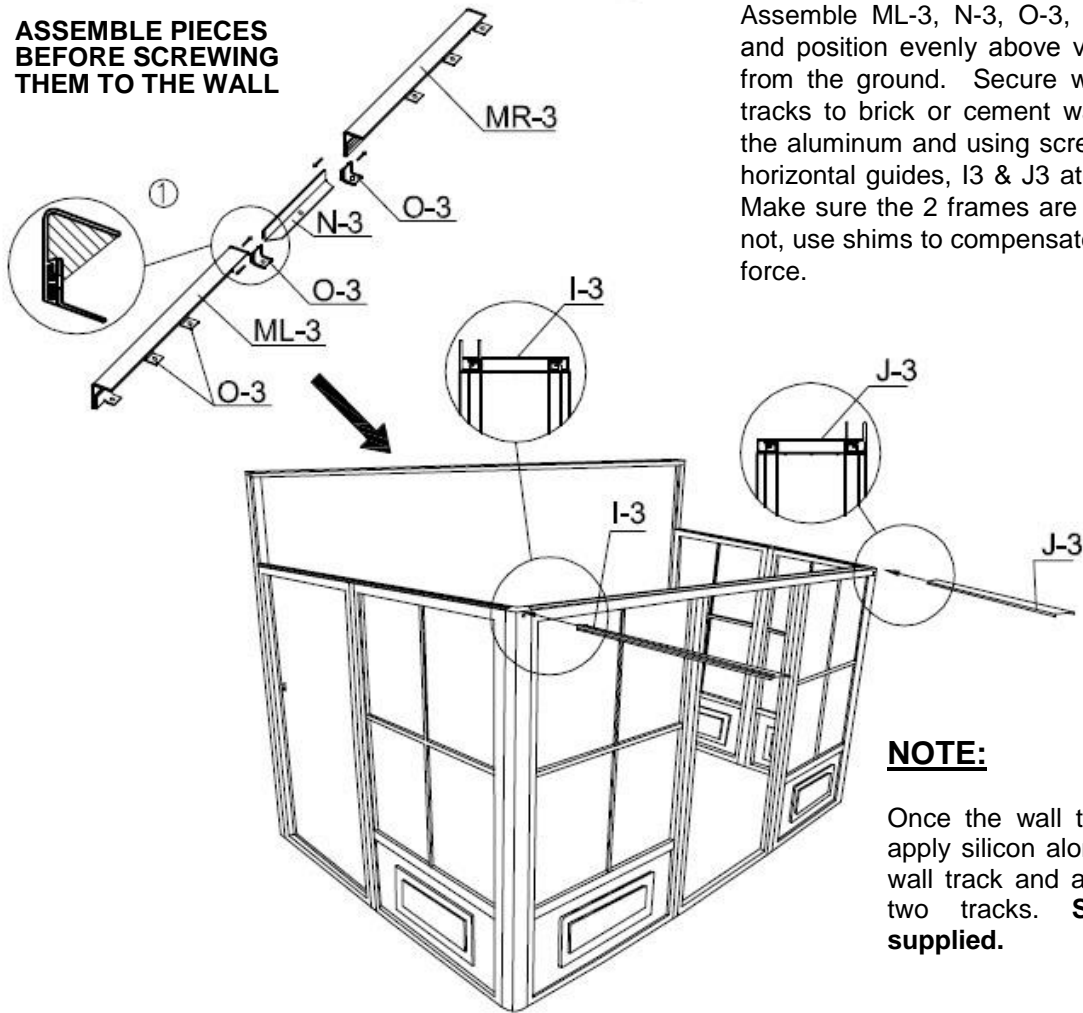

STEP #3

Assemble ML-3, N-3, O-3, and MR-3 as shown and position evenly above vertical guides, at 96" from the ground. Secure wall track and vertical tracks to brick or cement wall by drilling through the aluminum and using screws Xx-3. Insert the 2 horizontal guides, I3 & J3 at the top of the frame. Make sure the 2 frames are at the correct level, if not, use shims to compensate. Do not use tools to force.

NOTE:

Once the wall track is in place, apply silicon along the top of the wall track and at the joint of the two tracks. **Silicon is not supplied.**

STEP #4

Set polycarbonate exposed side on the outside over horizontal left guide I-3, use one (1) Rr-3 panel, one (1) P-3 joint and one (1) Ss-3 panel, then do the right side with one (1) Tt-3 panel, one (1) Q-3 joint and one (1) Uu-3 panel over the J-3 horizontal panel. Secure P-3 and Q-3 to I-3 and J-3 respectively with self-tapping screws (PQ-3).

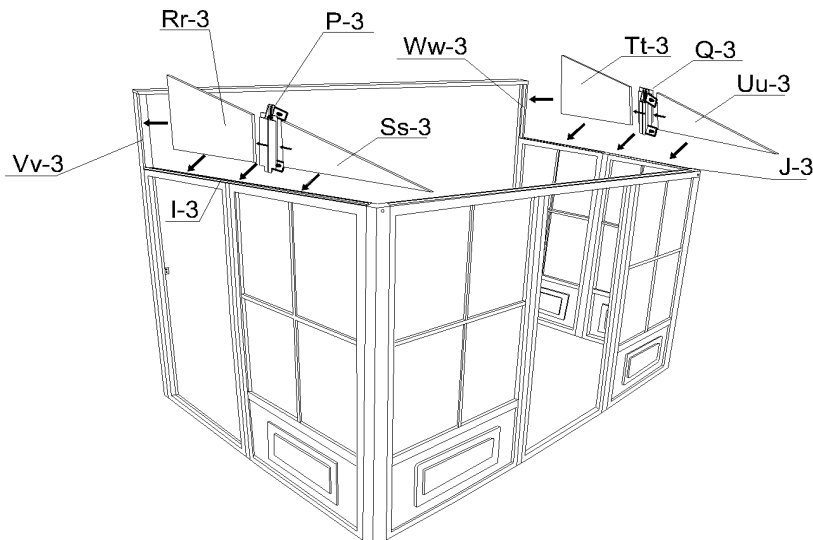

STEP #5

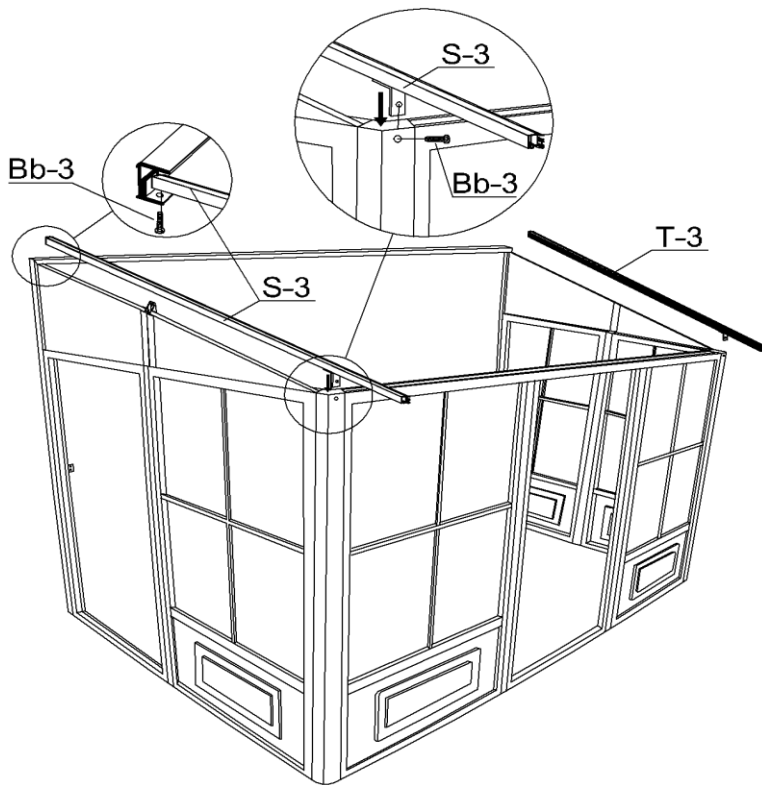

Set right rafter T-3 over last bracket then secure it with Bb-3 screw and continue screwing through joint K-3 with the Bb-3 screw. Secure to Q-3 bracket with self-tapping screw (PQ-3). Repeat on left side with rafter S-3.

STEP #6

Set U-3 rafters over the middle of each panel with Bb-3 screws at the top and two (2) Z-3 screws over the brackets on frame manually. Set U-3 rafter on each joint and use Z-3 screws manually. Do not use power drill.

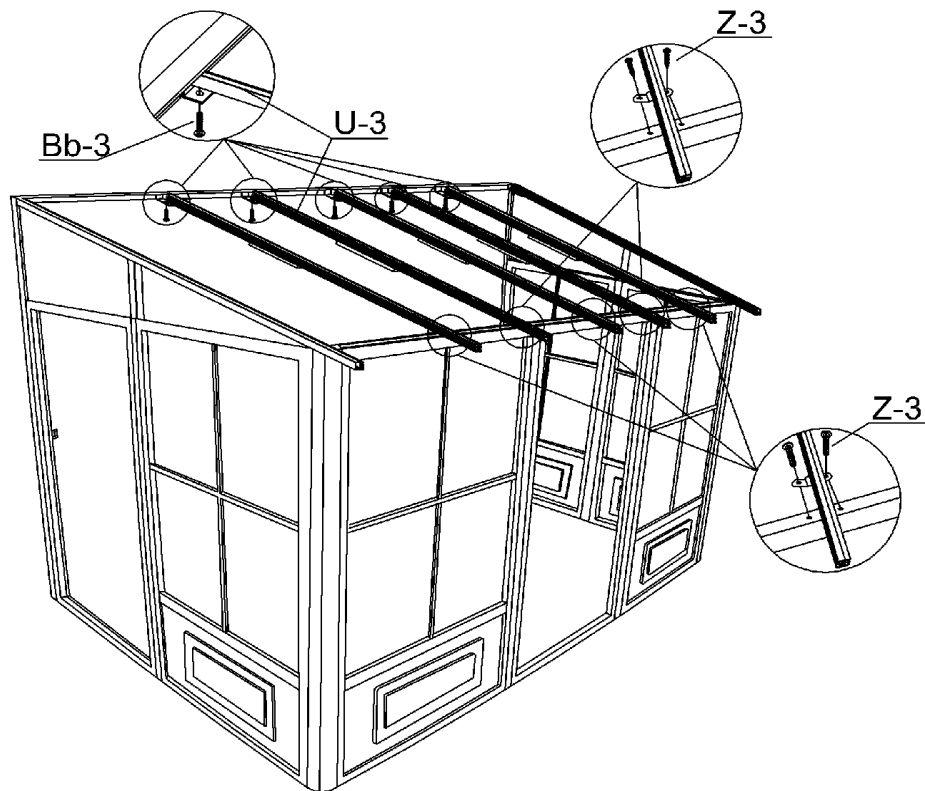

STEP #7

Remove protective film from two (2) sides of each panel and make sure the top side of the panel faces the sunlight. Insert and slide on the top groove of the rafters all the way to the end. Pp-3 should go first and last with the Qq-3 panels in between.

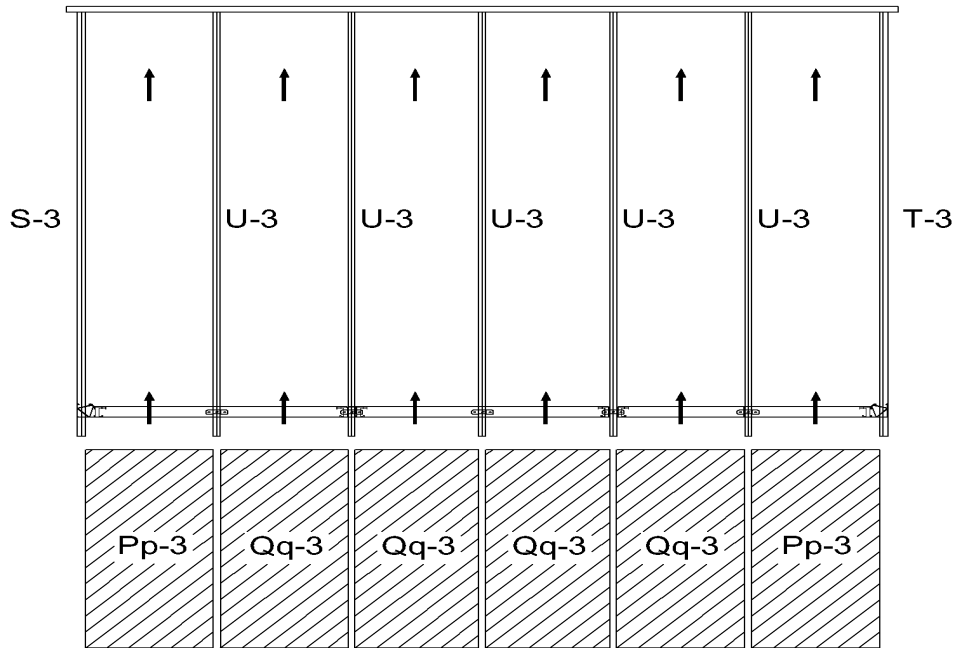

STEP #8

Insert the aluminum middle roof joint between the rafters, making sure the slotted holes are at the bottom. Slide into upper and lower grooves of the rafters then slide all the way into the panels. Make sure the panels are inside the aluminum middle roof joint groove. Insert a V-3 at either end, then insert all W-3 and then the remaining V-3. Tap gently with rubber mallet if needed.

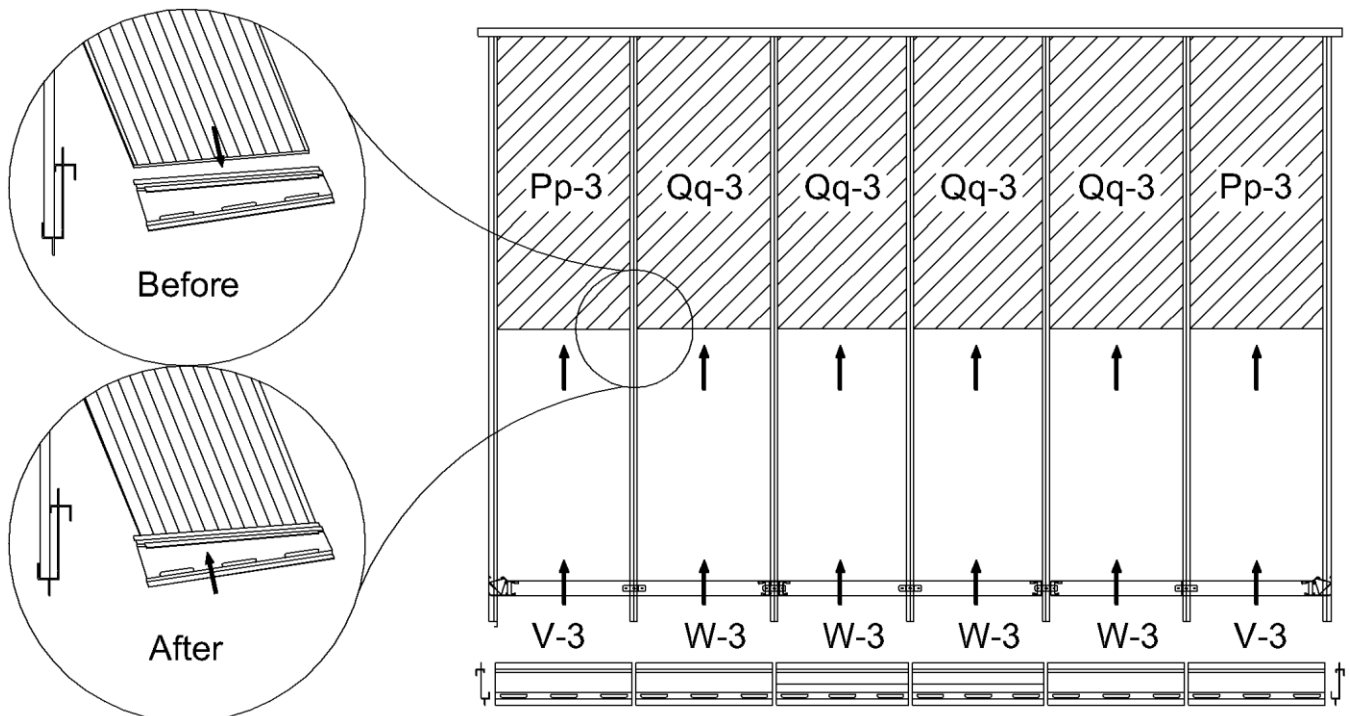

STEP #9

Insert the second row of panels into the lower groove on the rafter. Slide panels until they reach the aluminum pieces between the panels and gently tap on the panel to guide it into the aluminum groove. Use a spatula if needed to make it fit. Insert two (2) Pp-3 on either end, then insert the Qq-3 panels.

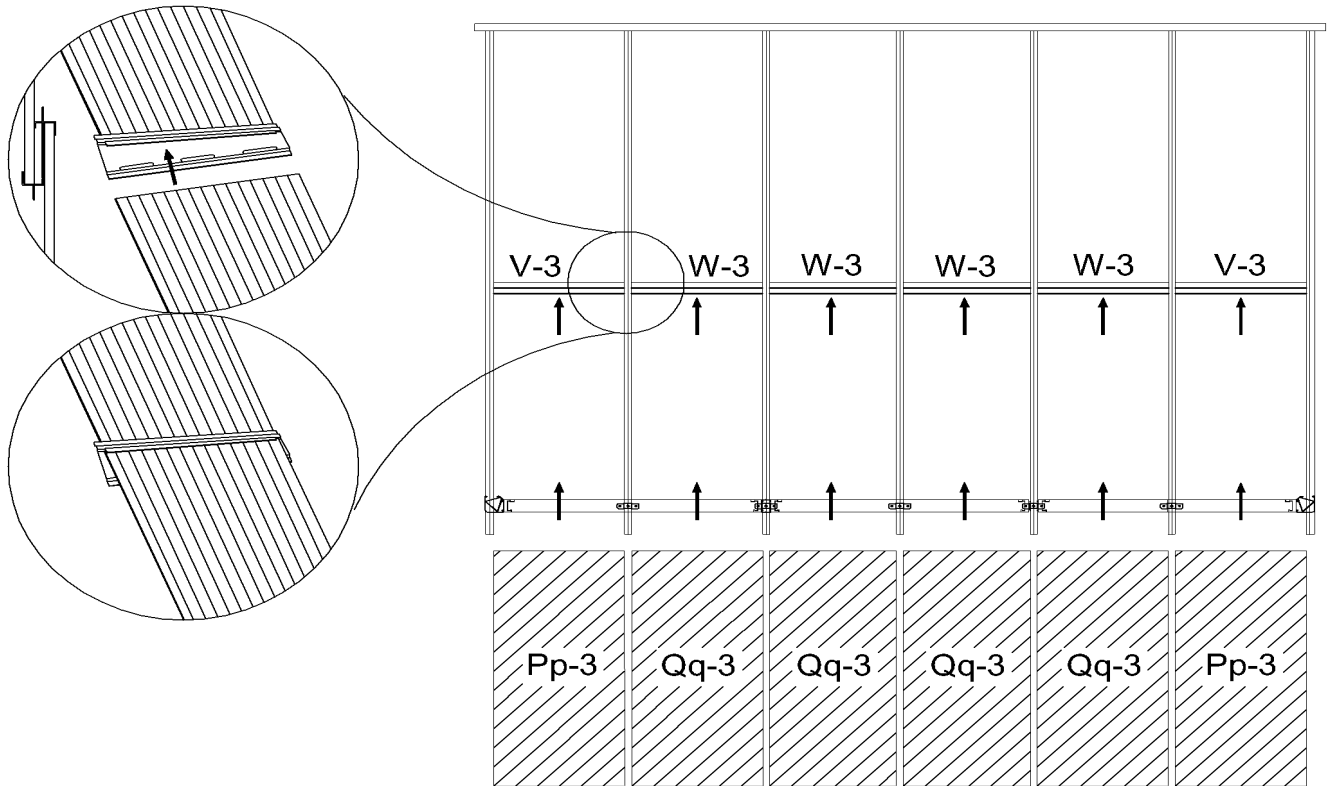

STEP #10

Starting at either end, add X-3 edging and one (1) R-3 bracket and screw with Bb-3 manually, do not use power drill. Add Y-3 edging and repeat until you reach the end, then add the X-3 edging.

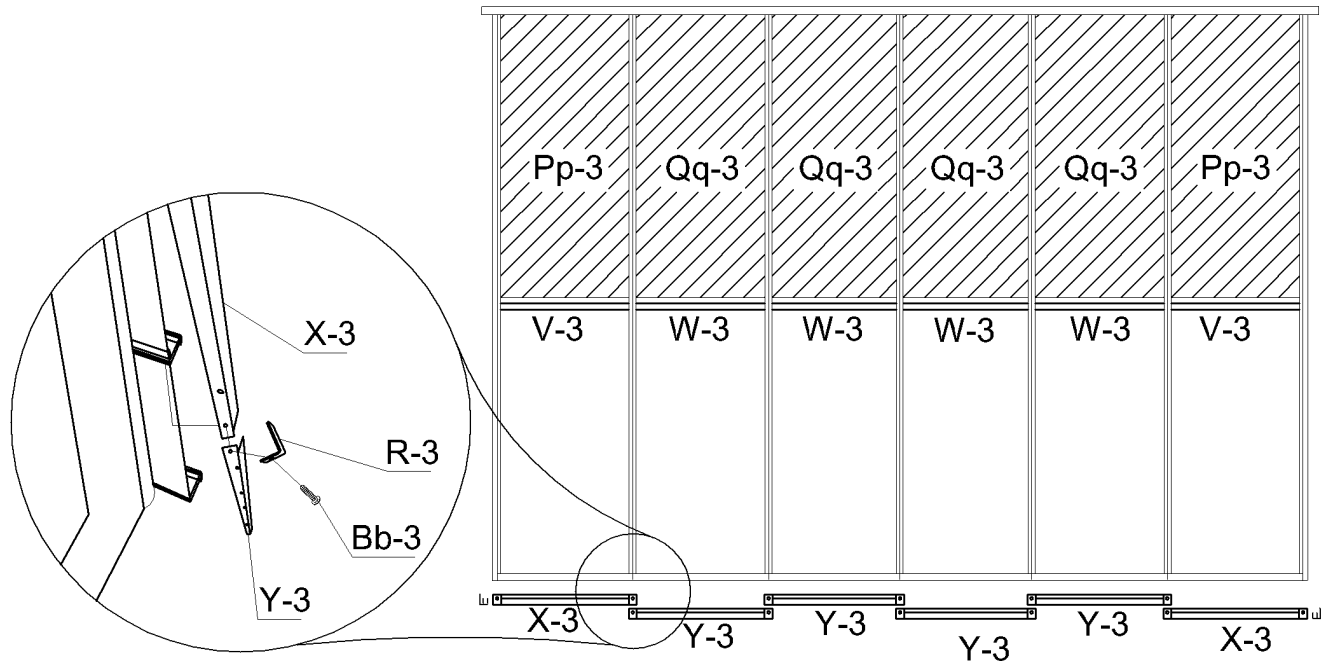

STEP #11

On the inside of the solarium under each rafter there are two rows of inserts with threads. Start the upper row with a Jj-3 at either end and screw it with Ff-3 and in between the Kk-3 panels. Use Ff-3 screws at the lower row LI-3 at the 2 ends then the others in between the Mm-3 panels. Make sure screws are manually tight.

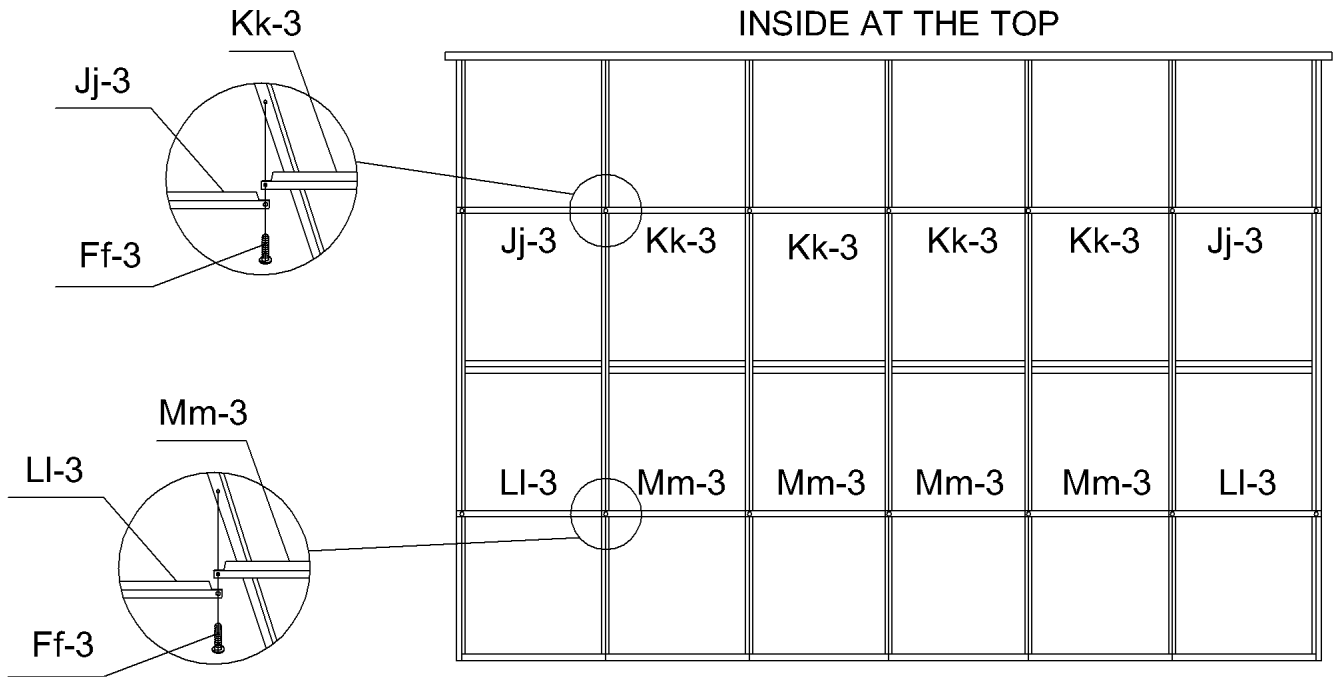

STEP #12

DOOR UNIT(S) MUST BE ASSEMBLED INSIDE OF SOLARIUM.

Slide upper door track F-3 into wheels of sliding door C-3. Slide lower door track G-3 and make sure inserts are close enough to the frame to attach. Use bolt Bb-3 to affix the plastic stopper H-3 on each end of top door rail F-3. Use Oo-3 screws to affix upper door rail and cap Nn-3, at each end of top rail door.

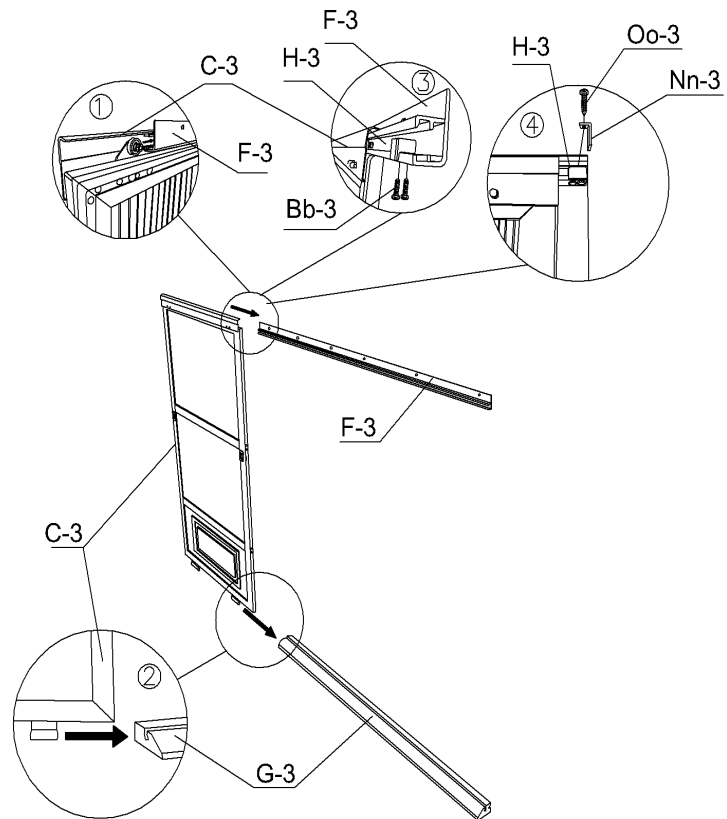

Sliding door should be installed from the inside of the solarium.

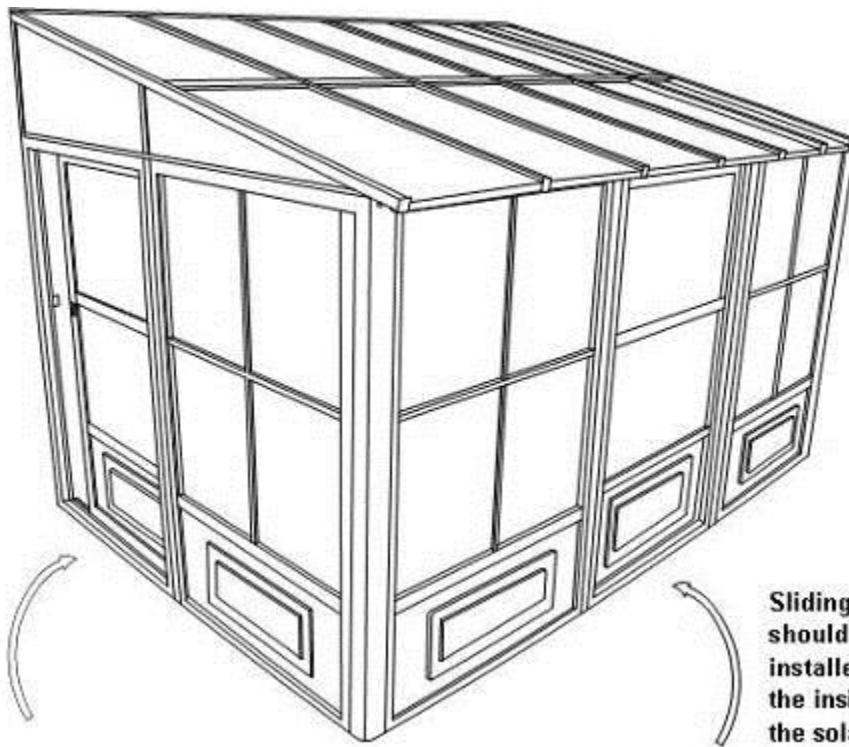

Sliding door should be installed from the inside of the solarium.

STEP #13

Lift up door and track inside of solarium then set it over the door opening by screwing at the top. First use bolts (Ww) and washers (Gg-3) on the inside and female bolts (Cc-3-2) on the outside for the top assembly. See diagram below. Attach lower track with bolts (Cc-3) and washers (Gg-3). Set up door latch on the side required for your door to lock, adjust latch as required.

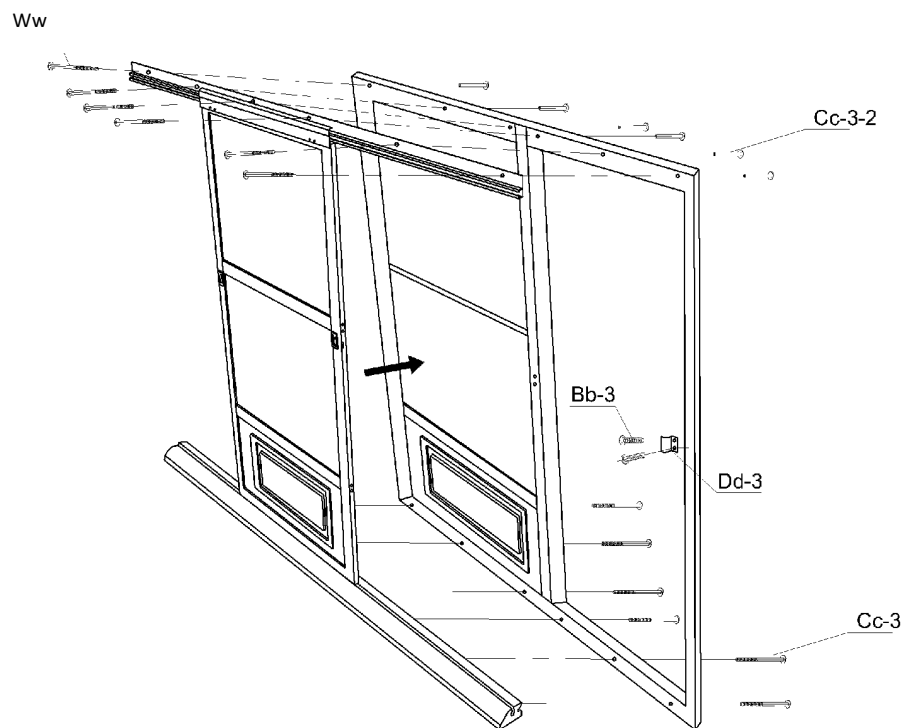

STEP #14

Anchor the solarium to the deck or floor securely using screws and shields supplied. See diagram below.

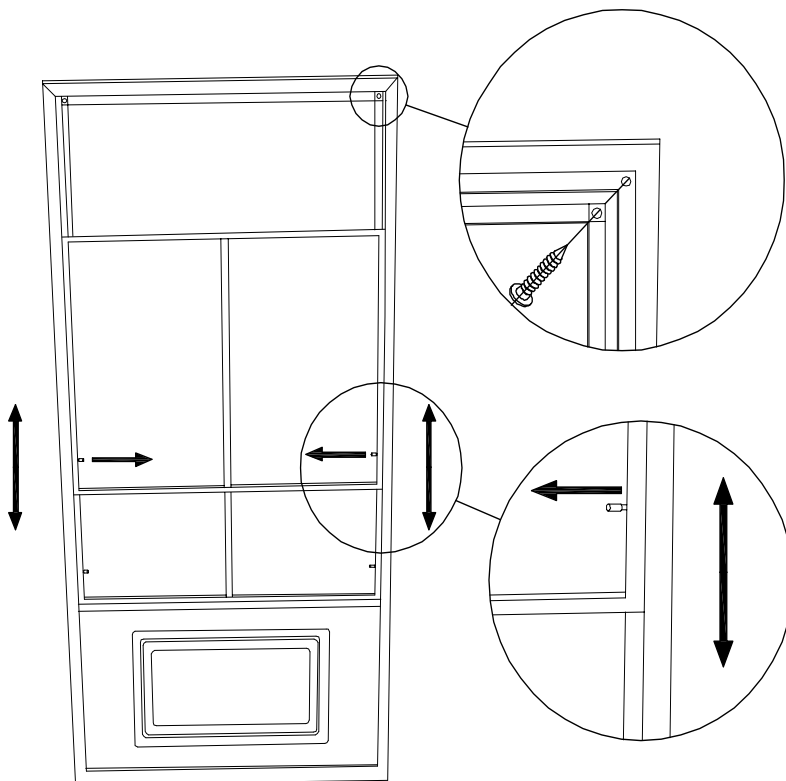
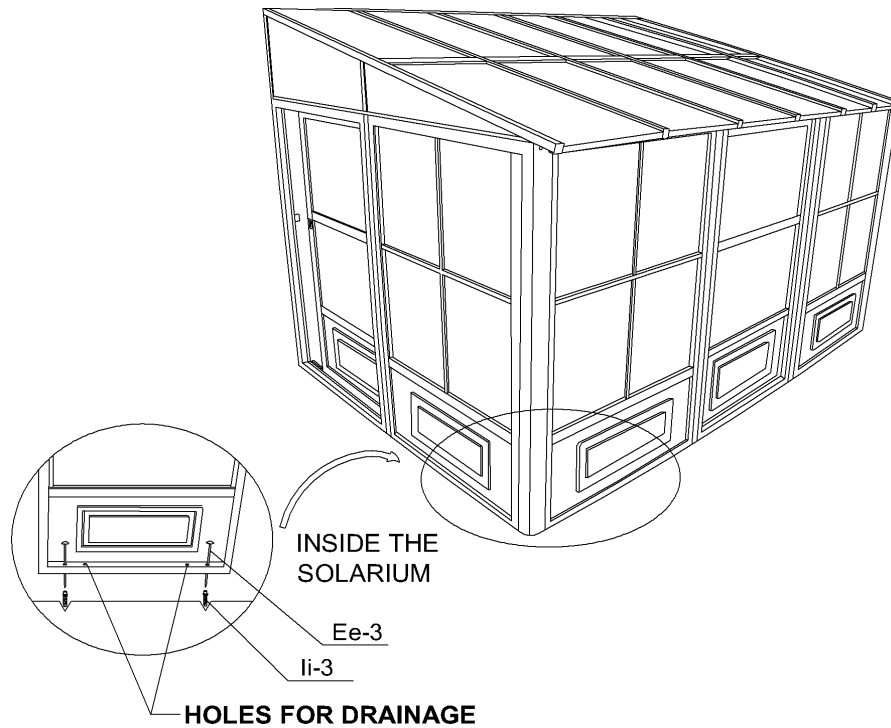

SPECIAL NOTES

To remove a screen, remove the two (2) screws at the top of the frame then pull sideways to the opposite end of the handles to remove. To remove wind panels, push or pull to one side, making sure that locking pin is not locked then remove panels gently, panels are easy to remove.

NOTE:

This unit is not waterproof. For best protection against rain, close the windows of each frame with the outside window in the center, and the inside window at the top.







CLEANING INSTRUCTIONS:



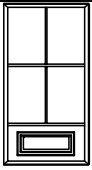
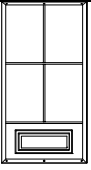
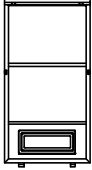
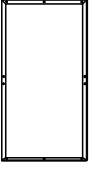
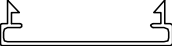
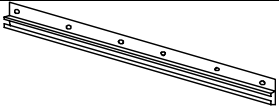
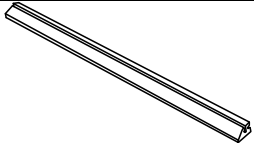
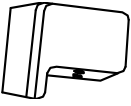
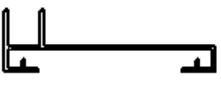
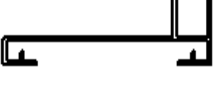

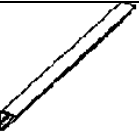

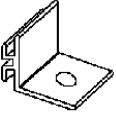
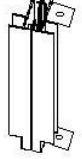
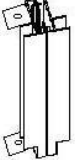
Use only mild or warm soapy water, no strong or abrasive cleaning products. Be sure to remove heavy snow and/or ice.

WARNING:

- 1) Do not use a BBQ or any other flammable product inside the solarium.
- 2) Remove snow from the roof.



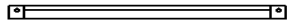
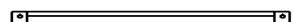
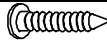
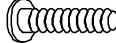
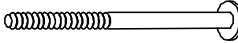
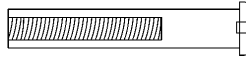
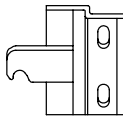
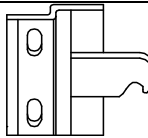
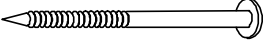
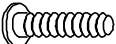

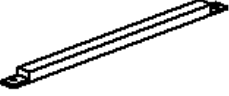

W1207-12 SAND PARTS LIST



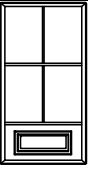
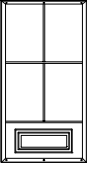
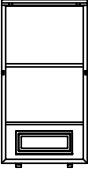
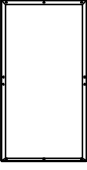
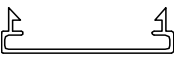
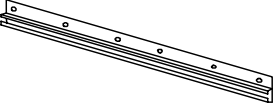
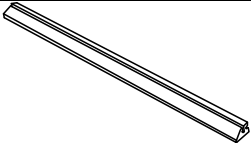
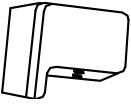
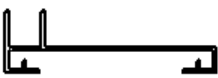





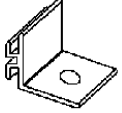
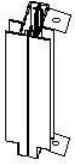
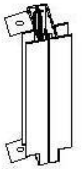
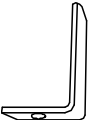

DESCRIPTION	PACKED IN BOX	QTY	DRAWING	DESCRIPTION	PACKED IN BOX	QTY	DRAWING
10-496-12 REGULAR FRAME A-3	3	3		10-497-12 FRAME NEXT TO DOOR B-3 (Has more holes)	2	2	
10-498-12 SLIDING DOOR C-3	2	2		10-499-12 SLIDING DOOR FRAME D-3	2	2	
11-544-12 CONNECTING PIECE E-3	4	8		11-545-12 TOP DOOR RAIL F-3	4	2	
11-546-12 BOTTOM DOOR RAIL G-3	4	2		08-138-12 PLASTIC STOPPER H-3	5	4	
10-500-12 LEFT SIDE RECEIVER I-3	4	1		10-501-12 RIGHT SIDE RECEIVER J-3	4	1	
10-502-12 CORNER CONNECTOR K-3	4	2		10-503-12 TRACK ML-3	4	1	
10-504-12 TRACK MR-3	4	1		10-505-12 TRACK JOINT N-3	5	1	
10-506-12 RAFTER BRACKET O-3	5	4		10-507-12 LEFT GABLE JOINT P-3	5	1	
10-508-12 RIGHT GABLE JOINT Q-3	5	1		10-509-12 ROOF RAFTER CAP R-3	5	7	

DESCRIPTION	PACKED IN BOX	QTY	DRAWING	DESCRIPTION	PACKED IN BOX	QTY	DRAWING
10-510-12 LEFT SIDE RAFTER S-3	4	1		10-511-12 RIGHT SIDE RAFTER T-3	4	1	
10-512-12 REGULAR RAFTER U-3	4	5		10-513-12 MIDDLE ROOF JOINT V-3	5	2	
10-514-12 MIDDLE ROOF JOINT W-3	5	4		10-515-12 EDGING X-3	5	2	
10-516-12 EDGING Y-3	5	4		08-156-12 SCREW Z-3	5	10	 (M4*16mm)
08-158-12 BOLT Bb-3	5	28	 (M6*16mm)	08-161-12 BOLT Cc-3	5	12	 (M6*70mm)
12-037-12 FEMALE BOLT Cc-3-2	5	12	 M6*60mm	08-169-12 LEFT DOOR LATCH Dd-L-3	5	2	
08-165-12 RIGHT DOOR LATCH Dd-R-3	5	2		08-167-12 SCREW Ee-3	5	10	 (M6*100mm)
08-168-12 BOLT Ff-3	5	16	 (M6*12mm)	08-187-12 WASHER Gg-3	5	22	
08-193-12 PLASTIC PLUG Ii-3	5	10		10-517-12 END ROOF CROSS BAR Jj-3	5	2	

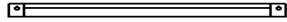
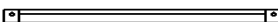
DESCRIPTION	PACKED IN BOX	QTY	DRAWING	DESCRIPTION	PACKED IN BOX	QTY	DRAWING
10-518-12 REGULAR ROOF CROSSBAR Kk-3	5	4		10-519-12 ROOF TOP REINFORCE LI-3	5	2	
10-520-12 ROOF TOP REINFORCE Mm-3	5	4		08-134-12 UPPER DOOR RAIL END CAP Nn	5	4	
08-135-12 SCREW Oo-3	5	8	 (M4*12mm)	10-521-12 (51 1/2" X 24 1/2") LEFT+RIGHT ROOF PANEL Pp-3	1	4	
10-522-12 (51 1/2" X 23") REGULAR ROOF PANEL Qq-3	1	8		10-523-12 LEFT BACK GABLE PANEL Rr-3	1	1	
10-524-12 LEFT FRONT GABLE PANEL Ss-3	1	1		10-525-12 RIGHT BACK GABLE PANEL Tt-3	1	1	
10-526-12 RIGHT FRONT GABLE PANEL Uu-3	1	1		10-527-12 LEFT WALL GUIDE Vv-3	4	1	
10-528-12 RIGHT WALL GUIDE Ww-3	4	1		10-529-12 SCREW FOR FIXING TO WALL Xx-3	5	18	
10-530-12 REGULAR TOP FILLER Yy-3	5	4		10-531-12 END TOP FILLER Zz-3	5	2	
13-045-12 SELF-TAPPING SCREW PQ-3	5	4		12-047-12 BOLT Ww	5	12	 M5*15mm

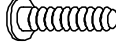
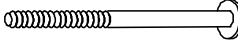
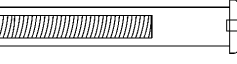
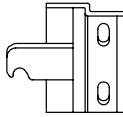
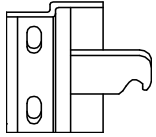
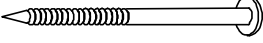
W1207-32 SLATE PARTS LIST

DESCRIPTION	PACKED IN BOX	QTY	DRAWING	DESCRIPTION	PACKED IN BOX	QTY	DRAWING
10-496-32 REGULAR FRAME A-3	3	3		10-497-32 FRAME NEXT TO DOOR B-3 (Has more holes)	2	2	
10-498-32 SLIDING DOOR C-3	2	2		10-499-32 SLIDING DOOR FRAME D-3	2	2	
11-544-32 CONNECTING PIECE E-3	4	8		11-545-32 TOP DOOR RAIL F-3	4	2	
11-546-32 BOTTOM DOOR RAIL G-3	4	2		08-138-32 PLASTIC STOPPER H-3	5	4	
10-500-32 LEFT SIDE RECEIVER I-3	4	1		10-501-32 RIGHT SIDE RECEIVER J-3	4	1	
10-502-32 CORNER CONNECTOR K-3	4	2		10-503-32 TRACK ML-3	4	1	
10-504-32 TRACK MR-3	4	1		10-505-32 TRACK JOINT N-3	5	1	
10-506-32 RAFTER BRACKET O-3	5	4		10-507-32 LEFT GABLE JOINT P-3	5	1	
10-508-32 RIGHT GABLE JOINT Q-3	5	1		10-509-32 ROOF RAFTER CAP R-3	5	7	

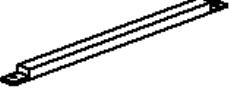
DESCRIPTION	PACKED IN BOX	QTY	DRAWING	DESCRIPTION	PACKED IN BOX	QTY	DRAWING
10-510-32 LEFT SIDE RAFTER S-3	4	1		10-511-32 RIGHT SIDE RAFTER T-3	4	1	
10-512-32 REGULAR RAFTER U-3	4	5		10-513-32 MIDDLE ROOF JOINT V-3	5	2	
10-514-32 MIDDLE ROOF JOINT W-3	5	4		10-515-32 EDGING X-3	5	2	
10-516-32 EDGING Y-3	5	4		08-156-32 SCREW Z-3	5	10	 (M4*16mm)
08-158-32 BOLT Bb-3	5	28	 (M6*16mm)	08-161-32 BOLT Cc-3	5	12	 (M6*70mm)
12-037-32 FEMALE BOLT Cc-3-2	5	12	 M6*60mm	08-169-32 LEFT DOOR LATCH Dd-L-3	5	2	
08-165-32 RIGHT DOOR LATCH Dd-R-3	5	2		08-167-32 SCREW Ee-3	5	10	 (M6*100mm)
08-168-32 BOLT Ff-3	5	16	 (M6*12mm)	08-187-32 WASHER Gg-3	5	22	
08-193-32 PLASTIC PLUG Ii-3	5	10		10-517-32 END ROOF CROSS BAR Jj-3	5	2	

DESCRIPTION	PACKED IN BOX	QTY	DRAWING	DESCRIPTION	PACKED IN BOX	QTY	DRAWING
10-518-32 REGULAR ROOF CROSSBAR Kk-3	5	4		10-519-32 ROOF TOP REINFORCE LI-3	5	2	
10-520-32 ROOF TOP REINFORCE Mm-3	5	4		08-134-32 UPPER DOOR RAIL END CAP Nn	5	4	
08-135-32 SCREW Oo-3	5	8	 (M4*12mm)	10-521-32 (51 1/2" X 24 1/2") LEFT+RIGHT ROOF PANEL Pp-3	1	4	
10-522-32 (51 1/2" X 23") REGULAR ROOF PANEL Qq-3	1	8		10-523-32 LEFT BACK GABLE PANEL Rr-3	1	1	
10-524-32 LEFT FRONT GABLE PANEL Ss-3	1	1		10-525-32 RIGHT BACK GABLE PANEL Tt-3	1	1	
10-526-32 RIGHT FRONT GABLE PANEL Uu-3	1	1		10-527-32 LEFT WALL GUIDE Vv-3	4	1	
10-528-32 RIGHT WALL GUIDE Ww-3	4	1		10-529-32 SCREW FOR FIXING TO WALL Xx-3	5	18	
10-530-32 REGULAR TOP FILLER Yy-3	5	4		10-531-32 END TOP FILLER Zz-3	5	2	
13-045-32 SELF-TAPPING SCREW PQ-3	5	4		12-047-32 BOLT Ww	5	12	 M5*15mm

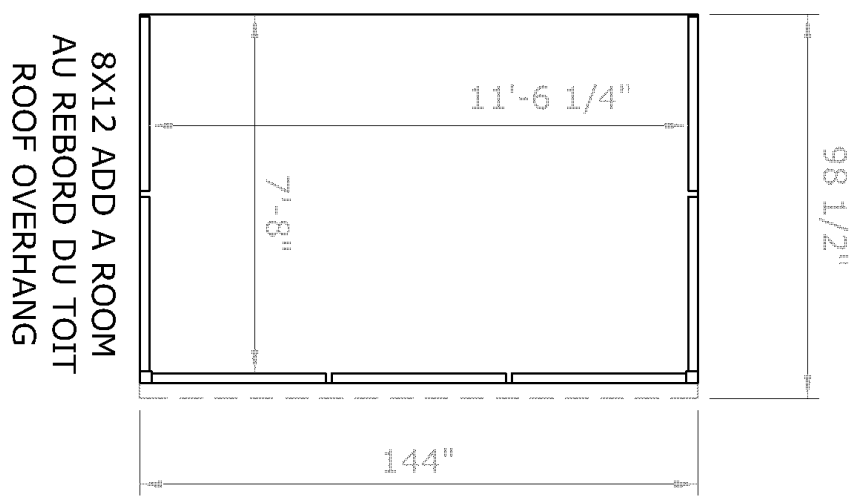
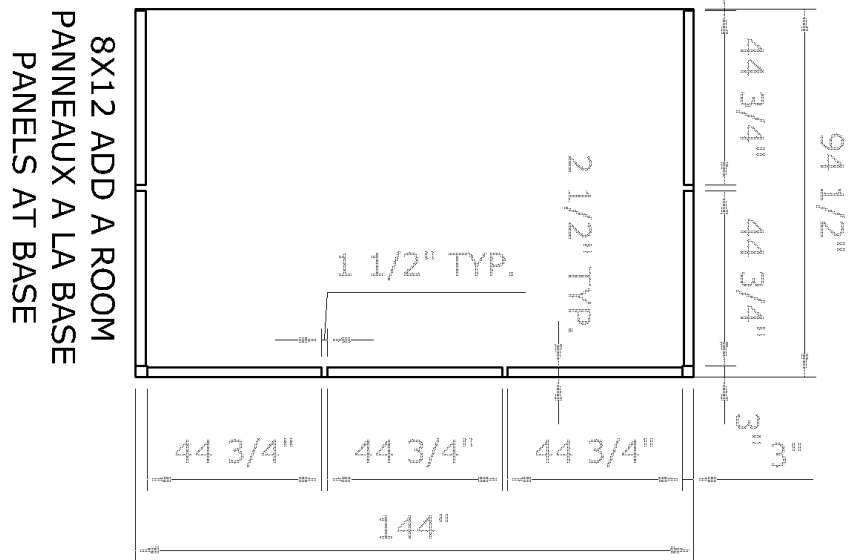

MAINTENANCE NOTES

1. In case of a defective or damaged part, or for any other questions concerning the product, please contact the manufacturer directly.
2. Please have the parts list and part numbers on hand when ordering or requesting replacement parts.
3. The product should not be installed adjacent to trees or a sloped roof. Snow and ice may slide onto the roof and cause it to collapse.
4. While the product is designed for 4 seasons use, the roof must be kept free of accumulation of snow.



ONE YEAR LIMITED WARRANTY

This product has been designed and manufactured to meet the highest standards of quality and durability. Subject to the Conditions for Exercising the Warranty and the Limitations on the Warranty set forth below, it is warranted to be free of material and manufacturing defects for a period of **one year** from the date of purchase. Should the product become damaged, or the warranty period has expired, please contact Gazebo Penguin Customer Service Department for a complete schedule of replacement parts and prices.

CONDITIONS FOR EXERCISING THE WARRANTY

The warranty only applies to the original purchaser with the bill.

In order to properly exercise your warranty, please comply with the following:

Carefully inspect the contents of the carton for missing or damaged components. Should you discover damaged or missing parts, **do not return the product to the place of purchase**, but contact Gazebo Penguin Customer Service Department at the numbers listed below:

Montreal: (514) 276-3485

Elsewhere: 1-800-737-7174

You can also find a claim form to fill out online :

<http://www.abrispenguin.com/forms.html>

LIMITATIONS ON THE WARRANTY

1. The product is not warranted against damages due to vandalism, abuse, falling or thrown objects, or accumulation of snow.
2. The product is not warranted against damages due to extreme weather conditions, such as thunderstorms, hail, strong wind or snow storms, or any other acts of God.
3. The product is only warranted in the event it is installed in accordance with the Gazebo Penguin's written instructions enclosed with the product.
4. The product is not warranted in the event it has been improperly anchored.
5. We reserve the right to replace or repair any defective product or parts at our discretion.