



Stonelum[®]

WARNINGS AND INSTRUCTIONS

WARNING: THIS APPLIANCE IS FOR OUTDOOR USE ONLY!

Table of Contents

Section 1	Safety Instructions	3
Section 2	General Description	4
2.1	Receiving Checklist	4
2.2	Product Dimensions	4
2.3	Product Contents	5
2.4	Safely Moving Unit	5
Section 3	Installation Details	6
3.1	Gas Requirements	6
3.1.1	Natural Gas	6
3.1.2	LP Gas (Liquid Propane)	6
Section 4	Operation	7
4.1	Ignition	7
4.1.1	Manual Light	7
4.1.2	Push Button Igniter	7
4.2	Adjustment & shutdown	8
4.3	Caring for Unit	8
4.4	Maintenance	8
4.5	Storage	8
Section 5	Troubleshooting	8
Section	Warranty	10

DO NOT DISCARD INSTRUCTIONS. THIS MANUAL HAS IMPORTANT OPERATING AND MAINTENANCE INSTRUCTIONS. LEAVE WITH THE HOMEOWNER.

Section 1 Safety Instructions

WARNING

Improper installation, adjustment, alteration, improper service or maintenance can result in injury or property damage. Before installing or servicing this equipment, read the installation, operation and maintenance instructions completely.

BURN HAZARD

While the fire pit is operating, the outside surface may reach high temperatures which may cause burns. Never leave children unattended in the area where the fire pit is being used. Close supervision of children is necessary when any appliance is used near children. Never leave the fire pit unattended when in use. When using the fire pit, do not touch the rock, wind guard, or immediate surroundings, as these areas become extremely hot and could cause burns. Do not reach over your fire pit when hot or in use. Do not store items of interest to children around or below the fire pit. Never allow children to sit or stand on any part of the fire pit.

FIRE OR EXPLOSION HAZARD If you smell gas:

1. Shut off gas to the appliance
2. Extinguish any open flame.
3. If odor continues, leave the area immediately.
4. After leaving the area, call your gas supplier or fire department.

WARNING

Do not leave unattended during use.
Do not use it for cooking.
Follow all gas leak procedures in this manual prior to operation.
Do not use charcoal or other solid fuel in gas burning appliances.
Do not heat any unopened glass or metal container of food in the fire pit, pressure may build up and cause the container to burst, possibly resulting in serious personal injury or damage to the fire pit.
Never allow clothing or other flammable materials to come in contact with any hot surface until it has fully cooled.
Never wear loose fitting or hanging garments while using your fire pit. The fabric can catch fire and cause personal injury.

CARBON MONOXIDE HAZARD

This appliance can produce carbon monoxide which has no odor. Using it in an enclosed area can kill you. Never use this appliance in an enclosed space without proper ventilation.

WARNING

Do not store or use gasoline or other flammable vapors and liquids in the vicinity of this or other appliance.

DANGER

Propane gas source to the fire pit must be regulated. Do not operate if the regulator has been removed. Fire or explosion can occur.

WARNING

Do not operate this fire feature in high-wind conditions. Operating in high-wind conditions may expose your model to direct flame, which will result in cracking and discoloration to the finish.
If used in a consistently windy area a wind guard will be required.
Always adhere to the specified clearances listed in this manual.

Note: Read the owner's information manual provided with this appliance. Installation and service must be performed by a qualified installer, service agency, or the gas supplier.

If the information in this manual is not followed exactly, a fire or explosion may result causing property damage, personal injury, or loss of life.

⚠ CALIFORNIA PROP 65 WARNING

This product can expose you to chemicals including Lead and Lead Compounds, which are known to the state of California to cause cancer, and Carbon Monoxide, Lead and Lead Compounds which are known to the state of California to cause birth defects or other reproductive harm. For more information go to www.P65Warnings.ca.gov.

Note: Extra caution should be taken when lighting a fire feature after heavy rains, high humidity and moisture are present. Light the fire feature; leave the area allowing any moisture in the media to dissipate. We strongly recommend that during this drying out time that you monitor the fire feature from a distance. This drying out period should be no less than 30 minutes. Continue monitoring the flame from a distance to ensure that all popping has ceased before fully enjoying the fire.

WE HIGHLY RECOMMEND COVERING ALL FIRE FEATURES WHEN NOT IN USE The use of a cover can lessen the impact of thermal spalling

Section 2 General Description

2.1 Receiving Checklist

Upon receiving fire feature from transportation carrier

1. Inspect the fire pit for damage.
2. Check that paperwork matches paperwork on pallet.
3. Open top of pallet and inspect unit for damage.

*If damaged, please notify the carrier immediately and sign "damaged" or do not receive. Please also notify Stonelum office immediately via email at info@stonelum.com

2.2 Product Dimensions

Refer to the corresponding diagram below for the unit you purchased.

CAIRO 01

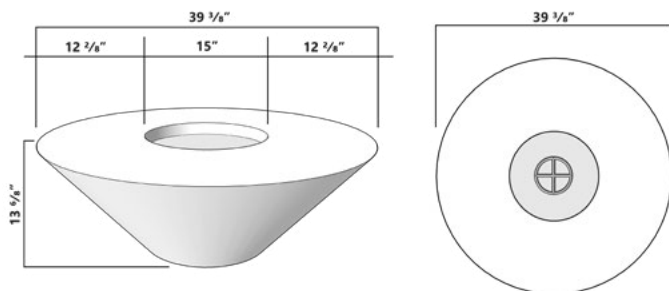

CAIRO 02

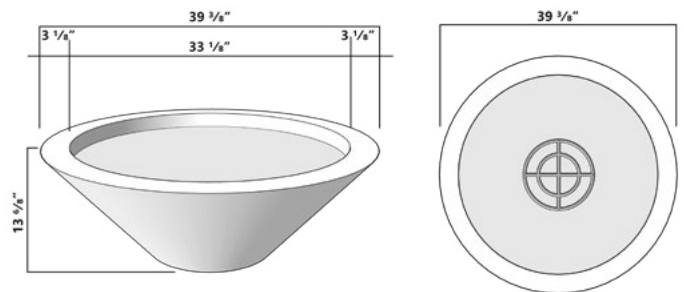

CAIRO 03

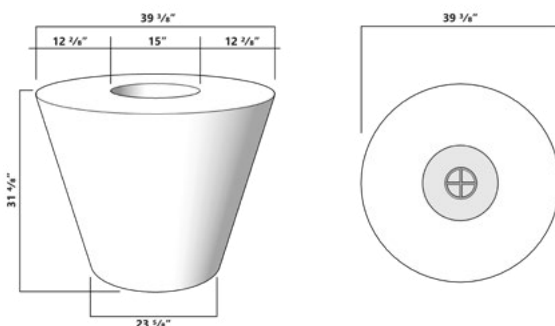

2.3 Product Contents

PART NAME	QTY
High Quality GFRC Fire Pit	1
Stainless Steel Burner	1
Internal hoses or tubes	1
Push Button Ignition Button	1
Security valve	1
Safety valve wrench	1
Lava Rock	1
Air Mixer (LP Gas Only)	1
Air Mixer Nipple (LP Gas Only)	1

2.4 Safely Moving Unit

- Never attempt to move your fire pit by yourself.
- Wrap with a blanket the entire body of the fire pit in order to protect it while moving.
- Use a dolly to navigate the unit to the final position.



DO NOT USE A WHEELBARROW OR OTHER UNBALANCED EQUIPMENT TO MOVE UNIT

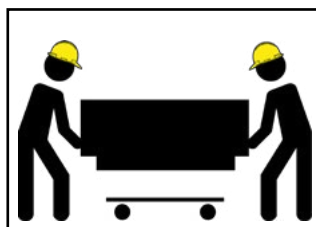

CAREFULLY REMOVE UNIT FROM CRATE AND PLACE ONTO MOVING DOLLY

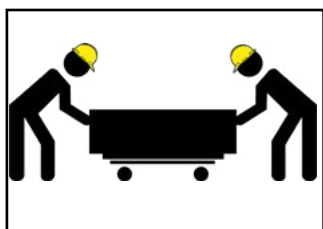

PLACE FIRE FEATURE WITH BASE DOWN TO MOVE

OR

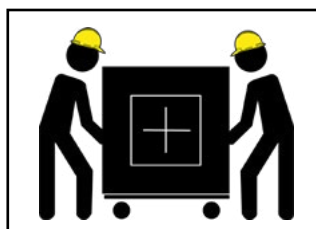

PLACE FIRE FEATURE ON SIDE TO MOVE
SECURE TRAY/BURNER PRIOR TO TILT
(ONLY FOR SQUARE OR RECTANGLE UNITS)

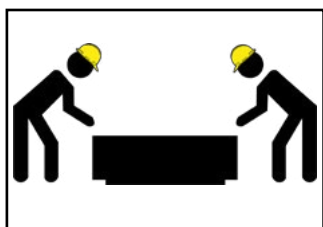

GENTLY PLACE FIRE FEATURE INTO FINAL POSITION

Section 3 Installation Details

3.1 Gas Requirements

The fire pit should be placed on a flat and level surface. It will arrive with the burner and burner plate set inside the unit. Burner hardware has been installed at the factory but will need to be checked for proper tightness after transportation. All units must have clearance to a combustible surface of 4ft on sides & 7ft from the top. Refer to the section below for the according to the gas type you purchased.

3.1.1 Natural Gas

Gas Pressure: 0.25 PSI

Gas Input Flow: 50,000 BTU/HR

Prior to installation, a gas professional should install an underground gas pipeline under the foundation where the fire pit will reside. To do this, your gas professional must first determine the best pipe size based on requirements fuel input rate (BTU/HR), fuel pressure gas and distance from pressure regulator gas to the fire pit. Once you have created a trench underground for your pipe, the end connection must be equipped with a valve ½" NPT ball shut-off (classified for use of gas) and a flare connection size for the same size gas hose that is connected to the faucet, valve and fire pit. Connect your flexible hose to the disconnected gas pipe and then connect the end to the valve key in your fire pit. The arrow on the valve key should point in the direction of gas flow (towards the fire pit plate in the fire function). Squeeze in all fittings with a wrench, do not tighten them by hand! Test gas lines for leaks and pressure loss over a period of 24 hours. When you have finished testing and there are no found leaks, cover the pipes, level the ground and finish laying the foundation. Once everything is hermetically sealed and connected, gently place the fire pit plate back into assumption; your fire pit is now ready to be placed in its final location.

Installation can be done only having the safe area and without any impediment that puts personnel at risk, taking into account the state climatological, in case the installation is outside. It must be remembered that in order to carry out a productive and efficient

facility, have as a requirement the following:

- a) Safety valve or stopcock for closure emergency, to manage the connection to the stock Fire Pit.
- b) Maximum height of pipe that supplies gas not greater than 3".
- c) Have a tube (copper or galvanized) to connect ½" socket with thread.
- d) Have a flow of fuel LP gas or gas natural, for leak testing and detection of gas leaks with EG AIR GAS DETECTOR.

Note: Check with your gas supplier to verify gas flows and available pressures at the place of its installation. In many cases, utility companies will install larger meters free of charge to accommodate larger flows

3.1.2 LP Gas (Liquid Propane)

Gas Pressure: 0.40 PSI

Gas Input Flow: 60,000 BTU/HR

Make sure the base is flat and level before placement. Units that use propane liquid will come with a fire pit, an orifice, a flexible hose and a regulator to be connected to the propane tank. This gas hose shall go from the tank to the fire pit. The hose must be connected from the tap valve inside of the unit, through a vent below and to the propane tank. Make sure all connections are tight with a wrench, do not tighten them by hand! An additional flexible hose will be connected from the end of the key valve to the flared fitting on the bottom of the fire pit. The arrow on the valve key should point in the direction of gas flow (towards the plate of the fire pit in the fire function). The fire pit does not include the LP gas tank; you will need to provide one. The LP gas tank must be constructed and marked according to the specifications for tanks as required by the Department of Transportation USA (DOT).

Section 4 Operation

4.1 Ignition

WARNING BEFORE LIGHTING

If the fire makes direct contact with the concrete firepit, it will cause cracks and discoloration. Verify that the decoration place near the burner does not obstruct the vertical gas flow that comes out of the orifices of the stainless steel burner.

Refer to the section below according to which ignition system you purchased. An initial burner test should be done prior to filling the pan with decoration (rocks/glass/etc.)

4.1.1 Manual Light

You will need a fireplace lighter, do not use a match or cigarette lighter as they are much shorter and will light the fuel too close to the burner which may result in serious injury. Ignite your fireplace lighter and hold the tip close to the burner. Insert fire table key and turn it to the ON position to start gas flow to the burner if you are using a propane tank unit, please note you will need to open the valve on your tank first. If your burner does not light within 5 seconds, turn the key to the OFF position and wait 10 seconds before trying again. If the burner still does not light, call your local gas technician to determine if there is a problem. Once the burner lights, immediately remove your hand and allow the burner to operate for a few minutes before turning it off. Make sure the valve is properly closed every time you leave your fire feature unattended and remove the key. For propane units, ensure that the valve on the tank is completely closed when the fire feature is not used.

You are now ready to place the decoration onto the burner pan. Slowly pour the medium onto the pan and spread evenly. Decoration should be sparsely spread out enough to cover the pan. Only use the recommended amount of decoration in your unit (the amount provided), overfilling may result in smaller flame and gas buildup which may cause an explosion. Fresh air must be able to pass through the unit. Do not block or obstruct any vents on lower and upper parts of the fire feature. These are

designed to ensure proper combustion and ensure no buildup of residual gasses within the unit.

4.1.2 Push Button Igniter

Confirm there is no debris in the fire pit (as mentioned in warnings) including water. Press the rubber push button to begin the spark. Open gas Key Valve by turning counter clockwise SLOWLY. Hold Button until flame ignites. Release push button switch when flame is present. Adjust valve to desired flame height. If Burner does not light, turn the valve off and allow gas to clear, then repeat steps. Never alter the design of the fire pit.

CAUTION: Open flames will ignite combustible materials such as clothing, fabric, hair, etc. which may result in serious injury, property damage and/or death. Be cautious of the open flames while the burner is lit.

4.2 Adjustment & shutdown

Close manual valve by turning clockwise- flame should extinguish. Remove the key and place it in a safe location away from children. Turn off fuel supply when not in use. Once the fire pit has cooled completely, use appropriate cover to protect the fire pit. Allow the fire feature and decoration to cool down before moving or adjusting. This may take from 30 minutes to 1 hour depending on the size of the fire feature. Any shifting of decoration or features should be done after the entire unit has cooled. Also prior to movement, ensure that all gas valves are completely closed and disconnected.

4.3 Caring for Unit

It is recommended to wipe the unit down before every use, and always clean any spills immediately so as not to allow stains to set in. Cleaning can be done with mild soap, water, and a rag.

4.4 Maintenance

Before every use, verify that all the gas connections are secure and that there are no visible damage or cracks on them. If you smell gas shut it off and extinguish any open flame in the surroundings,

continue as indicated in page 3. All natural gas hook-ups should be serviced and inspected only by qualified installers only. Spiders and other insects can nest in the burners and block the gas and airflow to the burner ports. This creates a dangerous condition that can result in a fire from behind the valve panel. Inspect and clean the burners periodically. Any guard or other protective device removed for servicing the appliance must be replaced prior to operating the appliance. Inspect the fuel supply connection for signs of leakage before each use of the appliance.

Do not repair or replace any part of your fire pit. Have a qualified technician perform all services. Any repairs made by a non-approved service technician will void your warranty.

4.5 Storage

When your fire pit is not in use, turn off the gas at the source. This appliance can be stored indoors only if it has been disconnected from its fuel supply. Store propane cylinders outdoors in a well-ventilated area out of reach of children. Disconnected cylinders must have threaded valve plugs tightly installed and must not be stored in a building, garage, or any other enclosed area. To extend the life of your fire pit, protect and cover it from the elements when not in use. Ensure the appliance has ample time to cool off after use and prior to installing storage cover. Damage caused to storage cover due to heat or burns are not covered by warranty.

Section 5 Troubleshooting

Refer to the section below according to which Gas Type you purchased.

BURNER WILL NOT LIGHT

Possible Cause	How to Fix
Air in Gas Line	If newly installed, it may take several attempts to purge air from line
Debris in Gas Line	Confirm the gas line is clear and free of obstruction (insulation, dirt, excess pipe sealer, water etc). Clearing lines of debris may require help from a professional.
Improper Gas Pressure	Liquid Propane Units: Check if the tank is low or empty, may need to be refilled or replaced. Natural Gas Units: Have a gas professional confirm gas pressure.

BURNER WILL NOT STAY LIT

Possible Cause	How to Fix
Improper Gas Pressure	Liquid Propane Units: Check if the tank is low or empty, may need to be refilled or replaced. Natural Gas Units: Have a gas professional confirm gas pressure.
Improperly Applied Fire Media	Media may be too dense; media will need to be reduced and evenly spread.

NOISE

Note: Only use gas hose supplied by the manufacturer as they have been tested for noise

Possible Cause	How to Fix
Gas Hose Restrictions	Remove any tight bends or kinks in the gas supply hose
Excessive Gas Flow	Check the gas regulator and reset if not within factory recommendations.

UNIT IS SMOKING

Possible Cause	How to Fix
Poor Fuel Quality	Liquid Propane Units: Inspect propane tank and hose, one or both may need to be refilled or replaced. Natural Gas Units: Contact local gas company
Excessive Flame Blockage	Separate and spread media (rocks or glass) evenly to allow flames to spread and pass-through media more evenly.
Improper Air/Fuel Mixture	Remove any foreign items or other combustible materials from the unit & check for proper orifice sizing.

BURNER FLAME IS TOO HIGH OR TOO LOW

Possible Cause	How to Fix
Incorrect Gas Supply Pressure	Liquid Propane Units: Inspect propane tank and hose, one or both may need to be refilled or replaced. Natural Gas Units: Contact local gas company.
Blocked burner ports or burner orifice	Clear burner ports and orifice of foreign particles or debris and wipe clean.
Improper Orifice Size	Verify burner orifice is the proper size for the fuel being used. Consult with factory by emailing info@stonelum.com

UNIT PRODUCING UNWANTED ODORS

Possible Cause	How to Fix
Gas Leak	DO NOT OPERATE -Turn off key valve but leave gas source on/open. (The gas should be flowing through the hose up to the igniter valve) Inspect hose(s), check for any leaks at all connections and fittings by using soapy water checking for bubbles. If a leak is found, turn off gas immediately and consult the factory about replacing damaged/defective components. If no leak is found: Liquid Propane Units: inspect propane tank for damage or defect, tank may need to be replaced. Natural Gas Units: contact local gas company to inspect

BURNER FLAME IS TOO HIGH OR TOO LOW

Possible Cause	How to Fix
Exposure	Concrete Units: Purchase cement sealer at your local brick and mortar retailer and apply a coat to concrete areas every year Wooden Units: Purchase IPE sealer at your local brick and mortar retailer and apply a coat to wood areas every year

Section Warranty

This product is warranted to be free from defects in material and workmanship for three years from the date of purchase. If a part proves to be defective under normal use, the part will be repaired or replaced. Our obligation under this warranty is to repair or replace defective parts at our discretion. If we determine that repair of a covered item is not feasible, we reserve the right to replace the defective merchandise with merchandise equal in value to the original purchase price. Warranty does not cover: freight, removal, re-installation, etc. There will be no charge for parts on a covered item, however, cost of labor is the responsibility of the owner. Shipping and handling charges will apply to all warranted replacement parts. The service agent may assess a reasonable travel or mileage charge per service call. This warranty is non-transferable. Decorative stones and decorative glass are not covered by this warranty. This warranty is void if the fire pit has been subject to negligence, alteration, misuse, repairs, dings, dents, scratches, or incorrect and / or prohibited applications as specified in the owner's manual. Natural gas lines must be installed by a licensed plumber only or local gas company agent. For more information regarding the warranty please send any questions to info@stonelum.com