

LINE	BBQ LINE
MODEL	FPT-S301M
NUM	

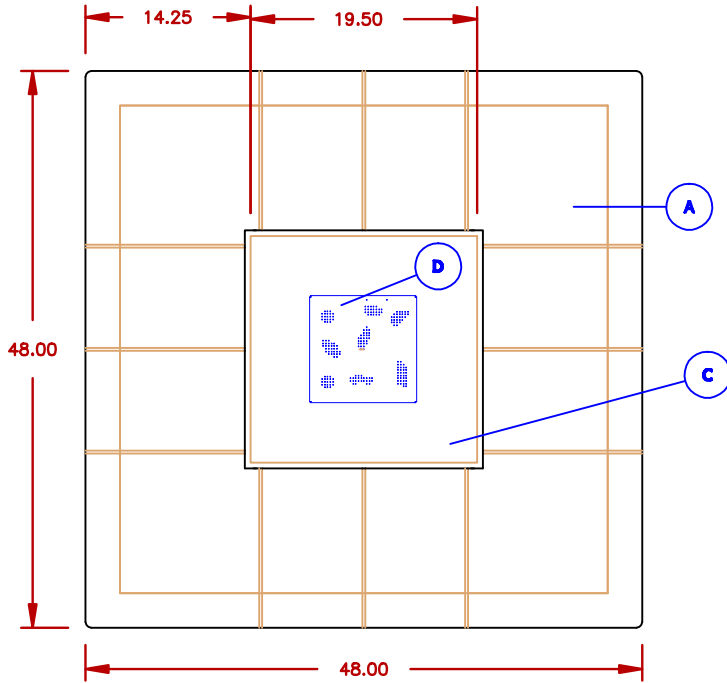

TOP VIEW

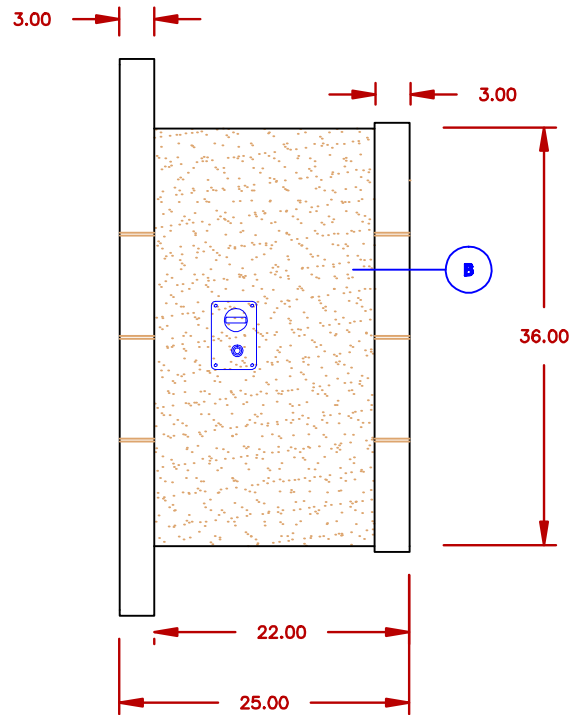

SIDE VIEW

OPTIONS		
SYMB.	DESCRIPTION	OPT#
OPT1	CULTURE STONE	OPTQ825
OPT2	NATURAL STONE TILE (FIELD) (BORDER)	OPTQ860
OPT3	3" BOTTOM TRIM (TILE ONLY)	OPTQ827
OPT4	18" VERTICAL DOOR	BBQ09841P-18

STANDARD FEATURES		
QTY.	SYMB.	DESCRIPTION
-	(A)	PORCELAIN TILE 12 X 12 (FIELD) (BORDER)
-	(B)	AMERISTONE STUCCO STANDARD FINISH
-	(C)	SQUARE FIRE BOX
1	(D)	BURNER BTU OUTPUT 55,000
4	(E)	STAND. FIRE LOGS SET W/ LAVA ROCKS 16"
1	(F)	LP STAND. NG CONVERTER
-	(G)	VENTILATION

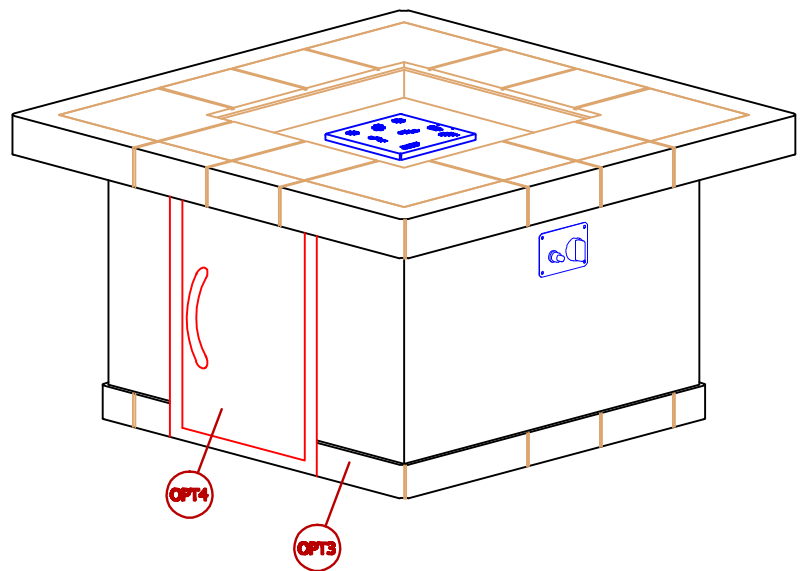

DIMETRIC VIEW

NOTE:
DUE TO OUR CONTINUOUS IMPROVEMENT PROGRAM, ALL MODELS
AND SPECIFICATIONS ARE SUBJECT TO CHANGE WITHOUT NOTICE.

	TITLE 2019 BARBECUE LINE FIREPIT SERIES FPT-S301M	
	SCALE:	DWG NO.
REVISED	REV. DESCR.	DWG BY J. ORNELAS
		DATE 11/9/18