

GIN 90 SERIES

FREESTANDING FIRE TABLE



Elegance, function and carefully conceived features combine to create a stunning focal point in the multi-functional Gin 90 Series of fire pit tables. Perfect for entertaining – whether in the home, hospitality or commercial setting – simply choose your preferred height (Low, Chat, Dining or Bar) and finish (Teak or Fluid Concrete) to complement your space and lifestyle and enjoy!

Finish

Available in a variety of Fluid concrete colours or Natural Teak finish.



Concrete Surround Options

Teak Surround Option

Global Compliance

LP/NG Burners are UL/ULC Listed. Bioethanol Burner is UL Listed, and ACCC Safety Mandate compliant.

Relocate with ease

When you select Bioethanol or Liquid Propane as your fuel source you'll never be tied down! With zero hard utility connections, relocating your fire is a breeze. Entertain on your own terms with EcoSmart Fire.

Functional Table Space

Tables feature space for accommodating food and drinkware.

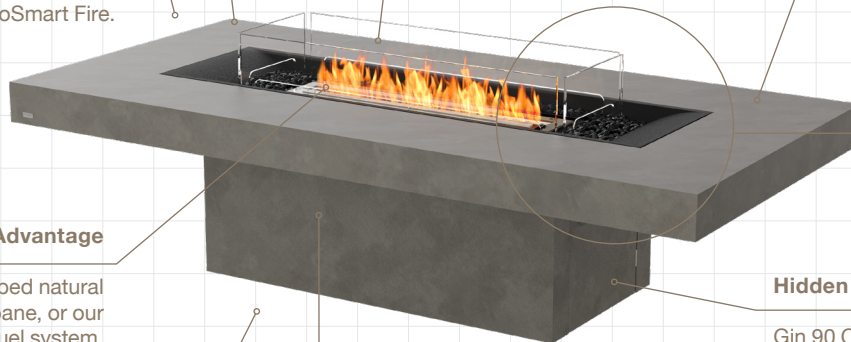

Burner Colors

Bioethanol models are available with a Stainless Steel or Black Burner.

Triple Fuel Advantage

Choose between plumbed natural gas, readily available propane, or our eco-friendly bioethanol fuel system. We make it easy for you to achieve exactly what you want, for exactly where you want it.

Hidden Gas Bottle

Gin 90 Chat, Dining and Bar models include a door to access the interior of the base compartment which is designed for convenient storage of the gas bottle.

Versatile and Incredibly Durable

EcoSmart portable fireplaces are versatile, incredibly durable, and are constructed of weather resistant materials. These appliances are designed to look great for years, and will perform admirably through all four seasons.

Included Accessories

Optional Accessory



Disclaimer: All product specifications and data are subject to change without notice and believed to be correct at the time of publication. MAD Design Group (MDG), its affiliates, agents, and employees, and all persons acting on its or their behalf (collectively, "MAD Design Group"), disclaim any and all liability for any errors, inaccuracies or incompleteness contained herein or in any other disclosure relating to any product. MDG disclaims any and all liability arising out of the use or application of any product described herein or of any information provided herein to the maximum extent permitted by law. The product specifications do not expand or otherwise modify MDG's terms and conditions of purchase, including but not limited to the warranty expressed therein, which apply to these products. No license, express or implied, by estoppel or otherwise, to any intellectual property rights is granted by this document or by any conduct of MDG. Customers using or selling MDG products not expressly indicated for use in such applications do so entirely at their own risk and agree to fully indemnify MDG for any damages arising or resulting from such use or sale. Please contact authorized personnel from MDG to obtain written terms and conditions regarding products designed for such applications. Images are indicative only.

Gin 90 Bar



Application	Outdoor and Indoor ¹
Materials	Fluid Concrete or Teak, Grade 304 Stainless Steel Burner, Toughened Glass Fire Screen
Weight (approx)	Concrete 180.5kg [397.1lbs] Teak 133kg [292.6lbs] Weight includes burner and accessories.

LP/NG		
Concrete SKU's	Natural	ESF.5.O.GIN.90.B.NA.G
	Bone	ESF.5.O.GIN.90.B.BO.G
	Graphite	ESF.5.O.GIN.90.B.GH.G
Teak SKU	Natural (Oiled)	ESF.5.O.GIN.90.B.TN.G

BIOETHANOL		
Concrete SKU's	Natural	ESF.5.O.GIN.90.B.NA.E
	Bone	ESF.5.O.GIN.90.B.BO.E
	Graphite	ESF.5.O.GIN.90.B.GH.E
Teak SKU	Natural (Oiled)	ESF.5.O.GIN.90.B.TN.E

Burner Colors	Stainless Steel or Black
----------------------	--------------------------

FUEL OPTIONS*	BTU/HR	BURN HOURS*
Liquid Propane	65,000	8 - 20
Natural Gas	65,000	Unlimited
Bioethanol	15,000	8 - 13

*These values are indicative only.

¹ Only bioethanol models are suitable to use indoors. For Indoor Use, additional parts are required. Your chosen application is the ONLY application the model can be used in due to modified configuration of the model. Please advise your Sales Representative at time of purchase so that the product can be configured accordingly. This model comes with fixing brackets for permanently locating into a fixed position.

Global Compliance
LP/NG Burners are UL/ULC Listed. Bioethanol Burner is UL Listed, and ACCC Safety Mandate compliant.

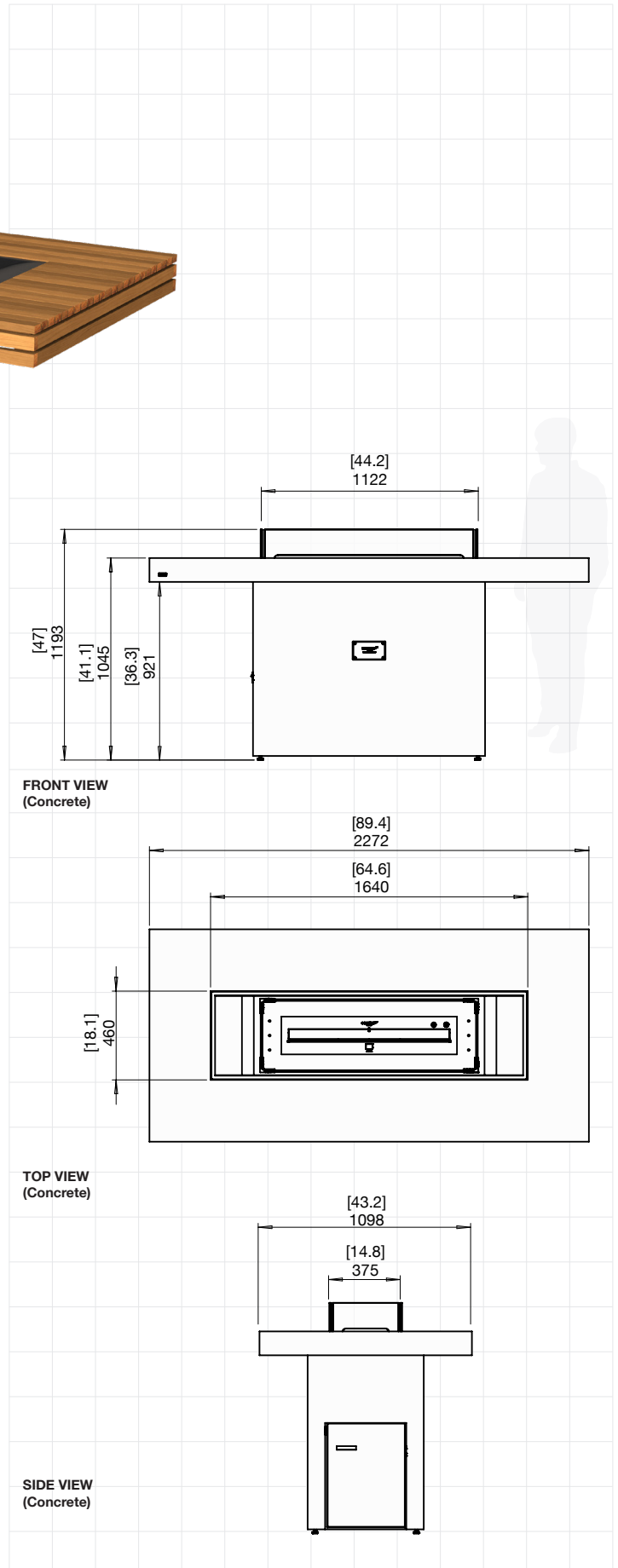





FOR MORE INFORMATION PLEASE REFERENCE THE CLEARANCE & INSTALLATION MANUAL

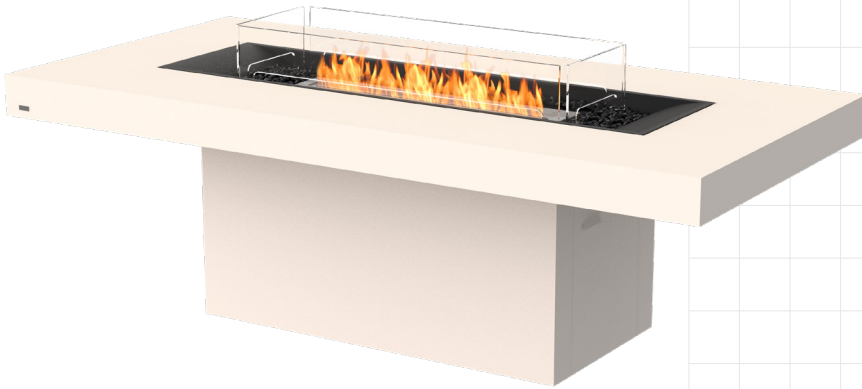



Disclaimer: All product specifications and data are subject to change without notice and believed to be correct at the time of publication. MAD Design Group (MDG), its affiliates, agents, and employees, and all persons acting on its or their behalf (collectively, "MAD Design Group"), disclaim any and all liability for any errors, inaccuracies or incompleteness contained herein or in any other disclosure relating to any product. MDG disclaims any and all liability arising out of the use or application of any product described herein or of any information provided herein to the maximum extent permitted by law. The product specifications do not expand or otherwise modify MDG's terms and conditions of purchase, including but not limited to the warranty expressed therein, which apply to these products. No license, express or implied, by estoppel or otherwise, to any intellectual property rights is granted by this document or by any conduct of MDG. Customers using or selling MDG products not expressly indicated for use in such applications do so entirely at their own risk and agree to fully indemnify MDG for any damages arising or resulting from such use or sale. Please contact authorized personnel from MDG to obtain written terms and conditions regarding products designed for such applications. Images are indicative only.

Gin 90 Dining



Application	Outdoor and Indoor ¹
Materials	Fluid Concrete or Teak, Grade 304 Stainless Steel Burner, Toughened Glass Fire Screen
Weight (approx)	Concrete 172.5kg [379.5lbs] Teak 128kg [281.6lbs] Weight includes burner and accessories.

LP/NG		
Concrete SKU's	 Natural	ESF.5.O.GIN.90.D.NA.G
	 Bone	ESF.5.O.GIN.90.D.BO.G
	 Graphite	ESF.5.O.GIN.90.D.GH.G
Teak SKU	 Natural (Oiled)	ESF.5.O.GIN.90.D.TN.G

BIOETHANOL		
Concrete SKU's	 Natural	ESF.5.O.GIN.90.D.NA.E
	 Bone	ESF.5.O.GIN.90.D.BO.E
	 Graphite	ESF.5.O.GIN.90.D.GH.E
Teak SKU	 Natural (Oiled)	ESF.5.O.GIN.90.D.TN.E

Burner Colors	Stainless Steel or Black
----------------------	--------------------------

FUEL OPTIONS*	BTU/HR	BURN HOURS*
Liquid Propane	65,000	8 - 20
Natural Gas	65,000	Unlimited
Bioethanol	15,000	8 - 13

*These values are indicative only.

¹ Only bioethanol models are suitable to use indoors. For Indoor Use, additional parts are required. Your chosen application is the ONLY application the model can be used in due to modified configuration of the model. Please advise your Sales Representative at time of purchase so that the product can be configured accordingly.

This model comes with fixing brackets for permanently locating into a fixed position.

Global Compliance
LP/NG Burners are UL/ULC Listed. Bioethanol Burner is UL Listed, and ACCC Safety Mandate compliant.

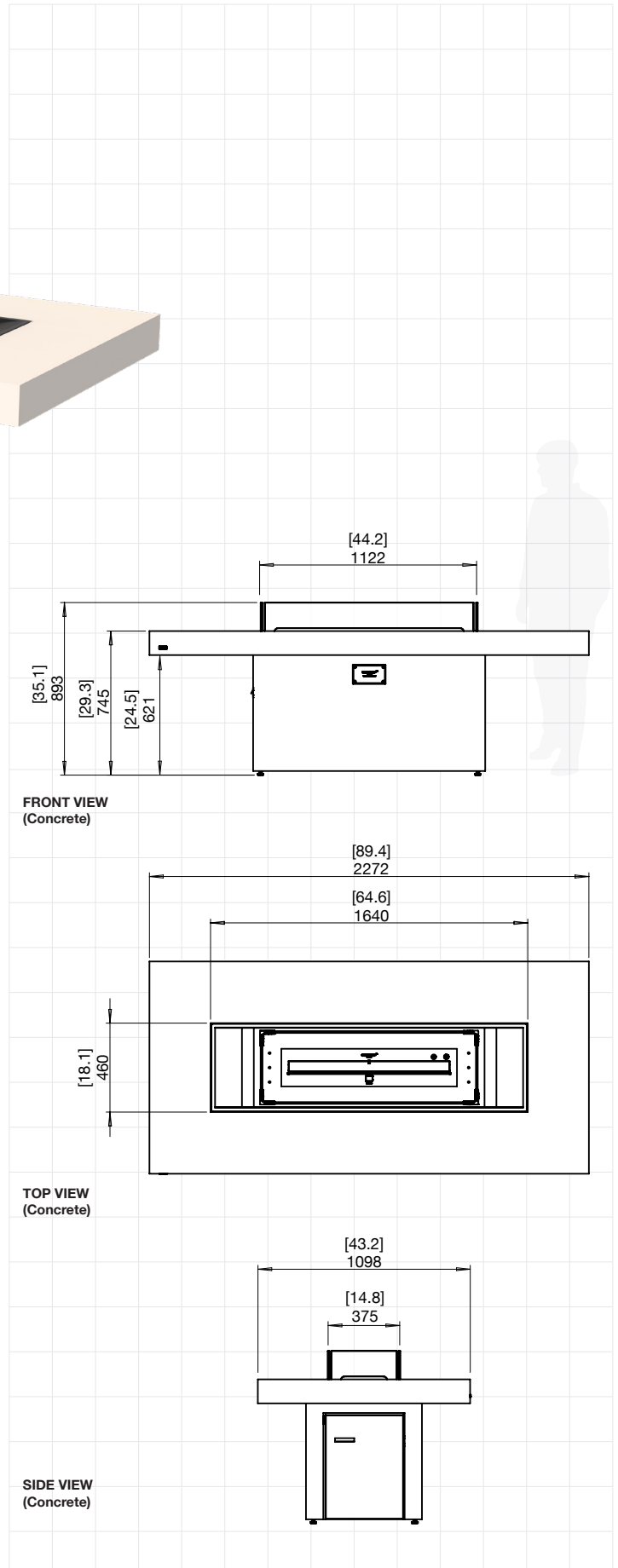





FOR MORE INFORMATION PLEASE REFERENCE THE CLEARANCE & INSTALLATION MANUAL





Disclaimer: All product specifications and data are subject to change without notice and believed to be correct at the time of publication. MAD Design Group (MDG), its affiliates, agents, and employees, and all persons acting on its or their behalf (collectively, "MAD Design Group"), disclaim any and all liability for any errors, inaccuracies or incompleteness contained herein or in any other disclosure relating to any product. MDG disclaims any and all liability arising out of the use or application of any product described herein or of any information provided herein to the maximum extent permitted by law. The product specifications do not expand or otherwise modify MDG's terms and conditions of purchase, including but not limited to the warranty expressed therein, which apply to these products. No license, express or implied, by estoppel or otherwise, to any intellectual property rights is granted by this document or by any conduct of MDG. Customers using or selling MDG products not expressly indicated for use in such applications do so entirely at their own risk and agree to fully indemnify MDG for any damages arising or resulting from such use or sale. Please contact authorized personnel from MDG to obtain written terms and conditions regarding products designed for such applications. Images are indicative only.

Gin 90 Chat



Application	Outdoor and Indoor ¹
Materials	Fluid Concrete or Teak, Grade 304 Stainless Steel Burner, Toughened Glass Fire Screen
Weight (approx)	Concrete 162.5kg [357.5lbs] Teak 119kg [261.8lbs] Weight includes burner and accessories.

LP/NG		
Concrete SKU's	 Natural	ESF.5.O.GIN.90.C.NA.G
	 Bone	ESF.5.O.GIN.90.C.BO.G
	 Graphite	ESF.5.O.GIN.90.C.GH.G
Teak SKU	 Natural (Oiled)	ESF.5.O.GIN.90.C.TN.G

BIOETHANOL		
Concrete SKU's	 Natural	ESF.5.O.GIN.90.C.NA.E
	 Bone	ESF.5.O.GIN.90.C.BO.E
	 Graphite	ESF.5.O.GIN.90.C.GH.E
Teak SKU	 Natural (Oiled)	ESF.5.O.GIN.90.C.TN.E

Burner Colors	Stainless Steel or Black
----------------------	--------------------------

FUEL OPTIONS*	BTU/HR	BURN HOURS*
Liquid Propane	65,000	8 - 20
Natural Gas	65,000	Unlimited
Bioethanol	15,000	8 - 13

*These values are indicative only.

¹ Only bioethanol models are suitable to use indoors. For Indoor Use, additional parts are required. Your chosen application is the ONLY application the model can be used in due to modified configuration of the model. Please advise your Sales Representative at time of purchase so that the product can be configured accordingly.

This model comes with fixing brackets for permanently locating into a fixed position.

Global Compliance
LP/NG Burners are UL/ULC Listed. Bioethanol Burner is UL Listed, and ACCC Safety Mandate compliant.

FOR MORE INFORMATION PLEASE REFERENCE THE CLEARANCE & INSTALLATION MANUAL

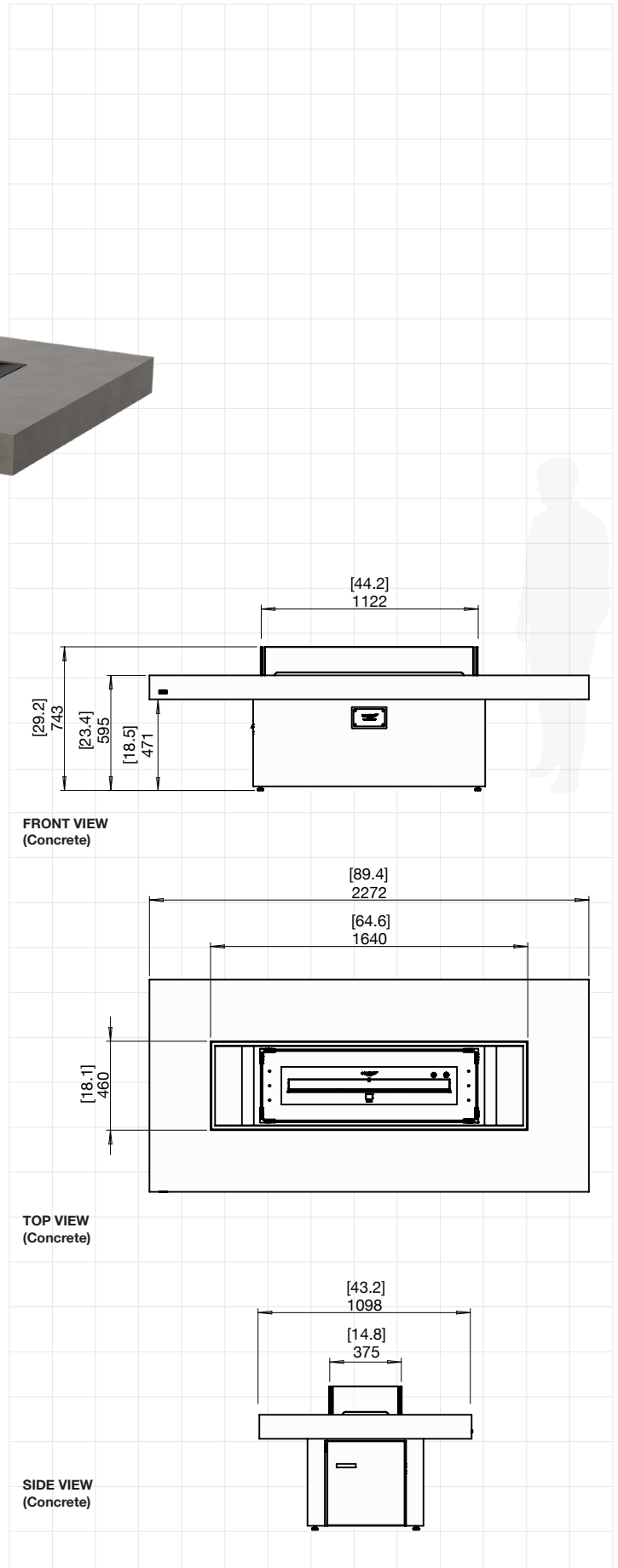

Disclaimer: All product specifications and data are subject to change without notice and believed to be correct at the time of publication. MAD Design Group (MDG), its affiliates, agents, and employees, and all persons acting on its or their behalf (collectively, "MAD Design Group"), disclaim any and all liability for any errors, inaccuracies or incompleteness contained herein or in any other disclosure relating to any product. MDG disclaims any and all liability arising out of the use or application of any product described herein or of any information provided herein to the maximum extent permitted by law. The product specifications do not expand or otherwise modify MDG's terms and conditions of purchase, including but not limited to the warranty expressed therein, which apply to these products. No license, express or implied, by estoppel or otherwise, to any intellectual property rights is granted by this document or by any conduct of MDG. Customers using or selling MDG products not expressly indicated for use in such applications do so entirely at their own risk and agree to fully indemnify MDG for any damages arising or resulting from such use or sale. Please contact authorized personnel from MDG to obtain written terms and conditions regarding products designed for such applications. Images are indicative only.



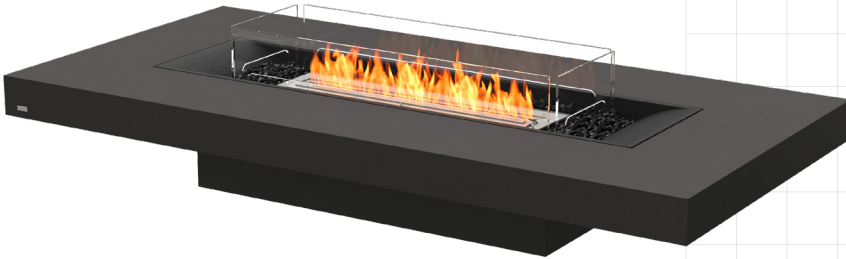

Gin 90 Low



Application	Outdoor and Indoor ¹
Materials	Fluid Concrete or Teak, Grade 304 Stainless Steel Burner, Toughened Glass Fire Screen
Weight (approx)	Concrete 154.5kg [339.9lbs] Teak 100kg [220lbs] Weight includes burner and accessories.

LP/NG		
Concrete SKU's	 Natural	ESF.5.O.GIN.90.L.NA.G
	 Bone	ESF.5.O.GIN.90.L.BO.G
	 Graphite	ESF.5.O.GIN.90.L.GH.G

Teak SKU	 Natural (Oiled)	ESF.5.O.GIN.90.L.TN.G
-----------------	---	-----------------------

BIOETHANOL		
Concrete SKU's	 Natural	ESF.5.O.GIN.90.L.NA.E
	 Bone	ESF.5.O.GIN.90.L.BO.E
	 Graphite	ESF.5.O.GIN.90.L.GH.E

Teak SKU	 Natural (Oiled)	ESF.5.O.GIN.90.L.TN.E
-----------------	---	-----------------------

Burner Colors	Stainless Steel or Black
----------------------	--------------------------

FUEL OPTIONS*	BTU/HR	BURN HOURS*
Liquid Propane	65,000	8 - 20
Natural Gas	65,000	Unlimited
Bioethanol	15,000	8 - 13

*These values are indicative only.

¹ Only bioethanol models are suitable to use indoors. For Indoor Use, additional parts are required. Your chosen application is the ONLY application the model can be used in due to modified configuration of the model. Please advise your Sales Representative at time of purchase so that the product can be configured accordingly.

This model comes with fixing brackets for permanently locating into a fixed position.

Global Compliance
LP/NG Burners are UL/ULC Listed. Bioethanol Burner is UL Listed, and ACCC Safety Mandate compliant.

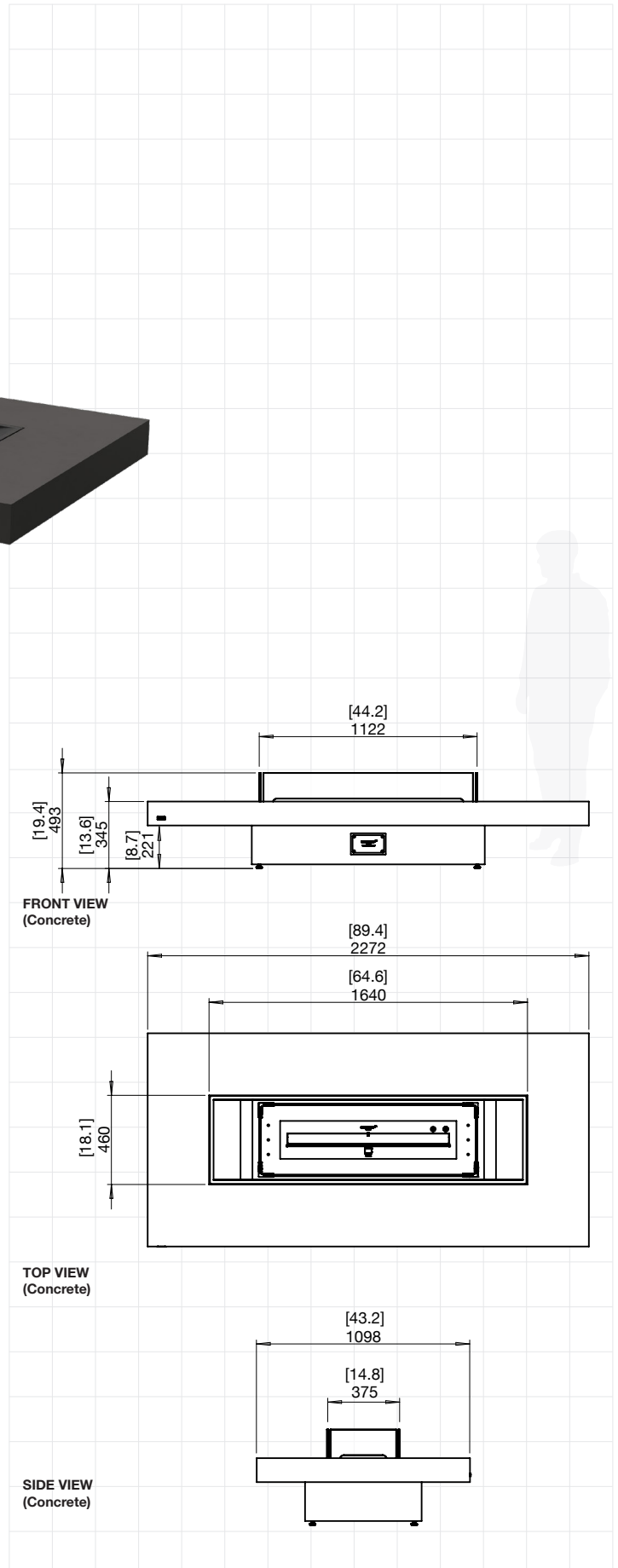

FOR MORE INFORMATION PLEASE REFERENCE THE CLEARANCE & INSTALLATION MANUAL

Disclaimer: All product specifications and data are subject to change without notice and believed to be correct at the time of publication. MAD Design Group (MDG), its affiliates, agents, and employees, and all persons acting on its or their behalf (collectively, "MAD Design Group"), disclaim any and all liability for any errors, inaccuracies or incompleteness contained herein or in any other disclosure relating to any product. MDG disclaims any and all liability arising out of the use or application of any product described herein or of any information provided herein to the maximum extent permitted by law. The product specifications do not expand or otherwise modify MDG's terms and conditions of purchase, including but not limited to the warranty expressed therein, which apply to these products. No license, express or implied, by estoppel or otherwise, to any intellectual property rights is granted by this document or by any conduct of MDG. Customers using or selling MDG products not expressly indicated for use in such applications do so entirely at their own risk and agree to fully indemnify MDG for any damages arising or resulting from such use or sale. Please contact authorized personnel from MDG to obtain written terms and conditions regarding products designed for such applications. Images are indicative only.