



PRISM HARDSCAPES
Outdoor Living Products

Cilindro

Fire Table



Installation, Operation & Maintenance Manual

WARNING: THIS APPLIANCE IS FOR OUTDOOR USE ONLY!



This manual should remain with the parties responsible for operation.

Table of Contents

Section 1: General Description

- 1.1 Receiving Checklist
- 1.2 Product Dimensions
- 1.3 Product Contents
- 1.4 Safely Moving Unit

Section 2: Safety Instructions

Section 3: Installation Details

- 3.1 Gas Requirements
- 3.2 Internal View of Components

Section 4: Operation

- 4.1 Ignition
- 4.2 Adjustment

Section 5: Troubleshooting

Section 6: Warranty

DO NOT DISCARD INSTRUCTIONS

Section 1

General Description

1.1 Receiving Checklist

Upon receiving fire feature from transportation carrier

- 1) Inspect the crate/pallet for damage
- 2) Check that PO/BOL paperwork matches paperwork on crate/pallet
- 3) Open top of crate/pallet and inspect unit for damage

*If damaged, please notify carrier immediately and sign "damaged" or do not receive. Please also notify Prism Hardscapes office immediately via email at warranty@prismhardscapes.com

1.2 Product Dimensions

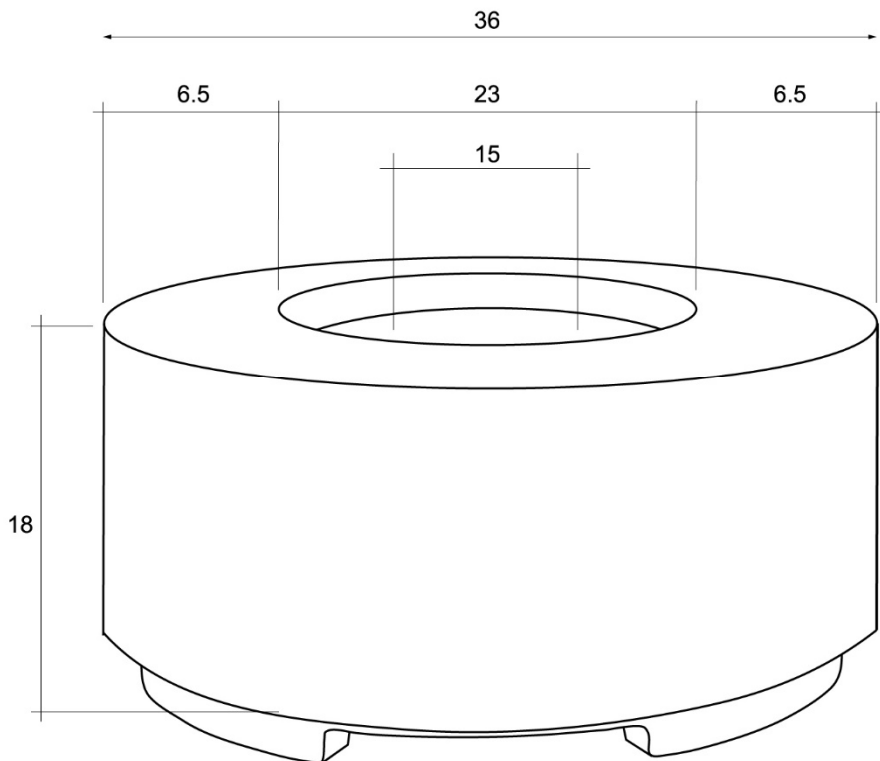

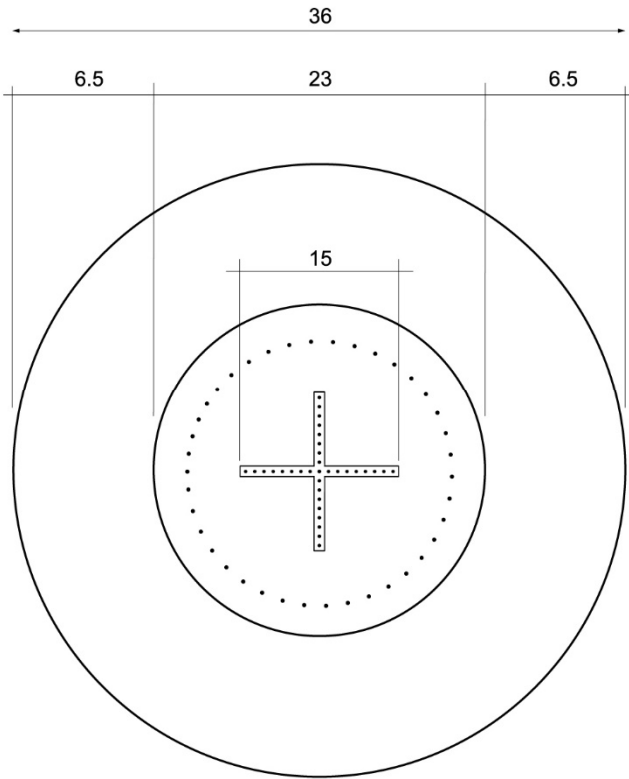

Overall Diameter	36"
Overall Height	18"
Pan Diameter	23"
Burner	15" 4-Spoke Burner
Weight	350lbs

1.3 Product Contents

PART NAME	QTY
BURNER	1
BURNER PAN	1
1/2" FEMALE TO MALE ORIFICE	1
1/2" FEMALE TO FLARE MALE INLET PIPE	1
1/2" FLEX LINE HOSE	1
LP HOSE (FOR LP UNITS ONLY)	1
1/2" FLARE	2
1/2" Ball Valve	1
Chrome Plated Cover	1
1 1/4" x 3" Washer	1
Key	1
Media (Lava Rock)	27lbs

1.4 Safely Moving Unit

- NEVER ATTEMPT TO MOVE YOUR FIRE FEATURE BY YOURSELF
- WRAP FURNITURE BLANKET AROUND THE ENTIRE BODY OF THE UNIT
- PLACE A PIECE OF ¾" PLYWOOD BETWEEN DOLLY AND THE FIRE FEATURE FOR INCREASED STABILITY WHILE MOVING
- USE DOLLY TO NAVIGATE THE UNIT TO THE FINAL POSITION



DO NOT USE A WHEELBARROW OR OTHER UNBALANCED EQUIPMENT TO MOVE UNIT

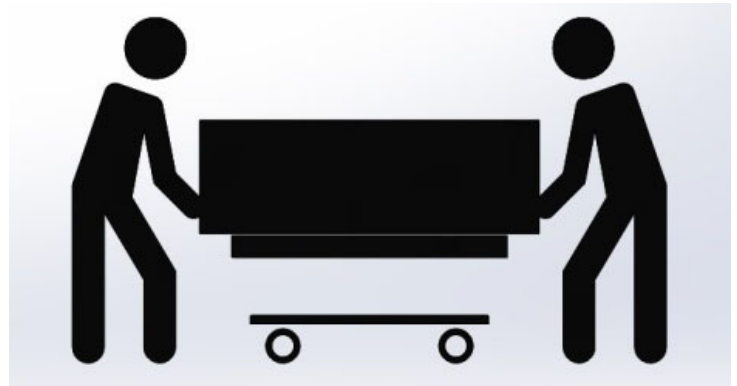

CAREFULLY REMOVE UNIT FROM CRATE AND PLACE ONTO MOVING DOLLY

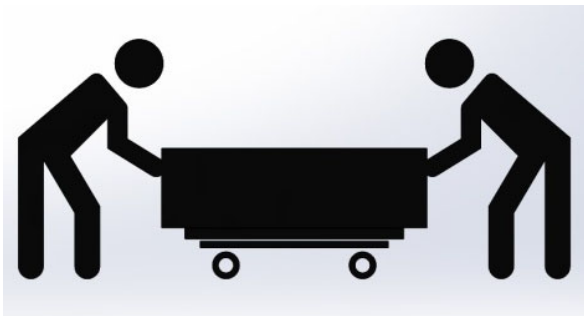

PLACE FIRE FEATURE WITH BASE DOWN TO MOVE

OR

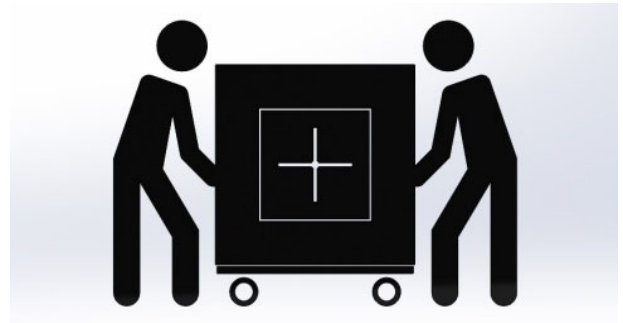

PLACE FIRE FEATURE ON SIDE TO MOVE
SECURE PAN/BURNER PRIOR TO TILT
(ONLY FOR SQUARE OR RECTANGLE UNITS)

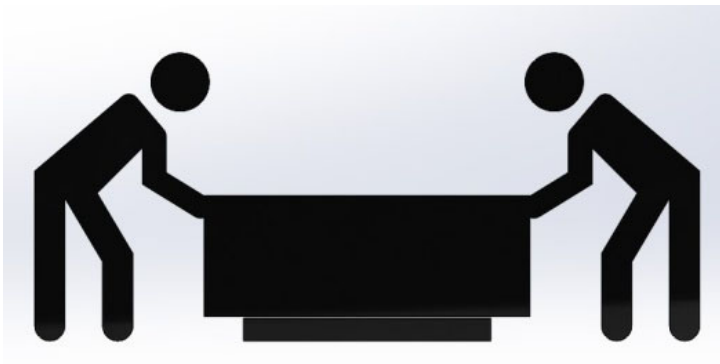

GENTLY PLACE FIRE FEATURE INTO FINAL POSITION

Section 2

Safety Instructions

WARNING

Before installing this product, read and follow all warning notices and instructions provided. Failure to do so may result in serious injury, property damage and/or death.

For additional product reference and copies of these instructions, visit our website at prismhardscapes.com

This product must be installed and serviced by a contractor or qualified installer who is licensed and/or certified within the jurisdiction where the product will reside. In the event no such state or local requirement exists, the installer or maintainer must be a qualified professional with sufficient experience in installation and maintenance of gas and/or electric appliances. Prior to installation, read and follow all warning notices and instructions provided with this product. Failure to do so may result in property damage, personal injury, and/or death. Improper installation and/or operation may result in exposure to carbon monoxide and flue gases which can cause serious injury, property damage, and/or death. For installations in the vicinity of occupied/living areas, Prism Hardscapes strongly recommends installation of carbon monoxide detectors within reach of this appliance and in any adjacent occupied spaces. Improper installation and/or operation will void warranty.

Do not store or use gasoline or other flammable vapors and liquids within the vicinity of this or any other appliance.

WHAT TO DO IF YOU SMELL GAS

- Immediately switch off main gas supply.
- Do not try to light any appliance.
- Do not touch any electrical switch; do not use any phone near unit.
- Immediately remove yourself from the area, call your gas supplier and follow their instructions.
- If you cannot reach your gas supplier, call the fire department.

Installation and service must be performed by a qualified installer, service agency or gas supplier.

THIS APPLIANCE IS FOR USE WITH PROPANE OR NATURAL GAS ONLY. AT NO TIME ARE SOLID OR ALTERNATIVE FUELS TO BE USED WITH THIS APPLIANCE.

Prism Hardscapes strongly recommends the installation of Carbon Monoxide detectors within reach of this appliance and in any adjacent occupied spaces.



CALIFORNIA PROPOSITION 65

This product can expose you to Chromium, which is known in the state of California to cause cancer, birth defects or other reproductive harm.

(for more information, go to: www.p65warnings.ca.gov)

WARNING

This appliance may produce carbon monoxide which has no odor. Using this appliance in an enclosed space such as a motorhome, camper, car or home may result in death.

Prism Hardscapes utilizes CSA certified components. Installation must conform to local codes, National Fuel Gas Code ANSI Z223.1/NFPA and/or National Fuel Gas Code.

Appliance should be serviced annually by a professional gas technician certified in the United States by the National Fireplace Institute (NFI). Any parts that require replacement should be replaced only by a certified service professional using parts recommended by manufacturer.

Do not alter any component or design of this unit as it may alter the operation and result in injury, property damage and/or death. Altering unit will also automatically void warranty.

This fire feature is not intended for cooking. Do not place anything on or in fire feature.

Never use fire feature in windy conditions.

Do not touch hot surfaces, hot media (rocks/glass/etc.) or open flames.

Do not reach, jump, or walk across unit, media or open flames.

Do not ignite fire feature when media (rocks/glass/etc.) are wet. Doing so may cause media to crack and burst.

It is important to inspect your fire feature before every use. Make sure there are no obstructions or combustible materials on or near unit.

Wipe down surface of unit before every use and immediately clean any spills or messes on or around unit.

Consistently check hoses and fittings for cracks, abrasions and leaks (at least once a month).

Do not leave pets or children unattended around fire feature.

Use a designated fire pit or barbecue cover when not in use.

Section 3

Installation Details

3.1 Gas Requirements

The fire table should be placed on a flat and level surface. It will arrive with the burner and burner plate set inside the unit. Burner hardware has been installed at the factory but will need to be checked for proper tightness after transportation. Refer to the corresponding section below for set-up on your unit. All units must have clearance to combustible surface of 4ft on sides & 6ft from the top. Refer to the section below for the according to the gas type you purchased.

3.1.1 Natural Gas

Gas Pressure: 7 inches water column

Gas Input Flow: 65,000 BTU/HR

Prior to installation, a gas professional will need to run a gas line underground below the foundation where your fire feature will reside. In order to do this, your gas professional will first need to determine the best pipe size based on fuel input requirements (BTU's/HR), gas pressure and distance from gas pressure regulator to fire feature. Once you have created a trench underground for your pipe, the stubbed-out end should be fitted with a ½" NPT ball valve shutoff (rated for gas usage) and a flare fitting sized for the same size gas hose that is attached to the key valve and burner. Connect your flex hose to the stubbed-out gas pipe then connect the other end to the key valve in your fire feature. The arrow on the key valve should be pointing the direction of the gas flow (towards the burner plate on your fire feature). Tighten all fittings with a wrench, do not hand tighten! Test the gas lines for leaks and loss of pressure over a 24-hour period. When you are finished testing and have found no leaks, cover the pipes, level the ground and finish setting the foundation. Once everything is tightly sealed and connected, gently place your burner plate back down into your fire feature; your fire table is now ready to be positioned in its final location.

Note: Check with your gas supplier to verify gas flows and pressures available at the location of your installation. In many cases utility companies will install larger meters at no charge to accommodate larger flows.

3.1.2 Liquid Propane

Gas Pressure: 11 inches water column

Gas Input Flow: 65,000 BTU/HR

Make sure the foundation is flat and level prior to placement. Units using liquid propane will come with a burner, orifice, flex hose and regulator that will attach to the propane tank. This gas hose will need to go from the tank to the burner. The hose should connect from the key valve within the unit, through a vent underneath and to the propane tank. Make sure all fittings are tightened properly with a wrench, do not hand tighten! An additional flex hose will be attached to the other end of the key valve to the flare fitting at the bottom of the burner. The arrow on the key valve should be pointing the direction of the gas flow (towards the burner plate on your fire feature).

Fire features do not include propane cylinder; you will need to provide one. The liquid propane supply cylinder must be constructed and marked in accordance with the specifications for propane gas cylinders as required by the U.S. Department of Transportation (DOT).

3.2 Internal View of Components

3.2.1 Natural Gas Unit

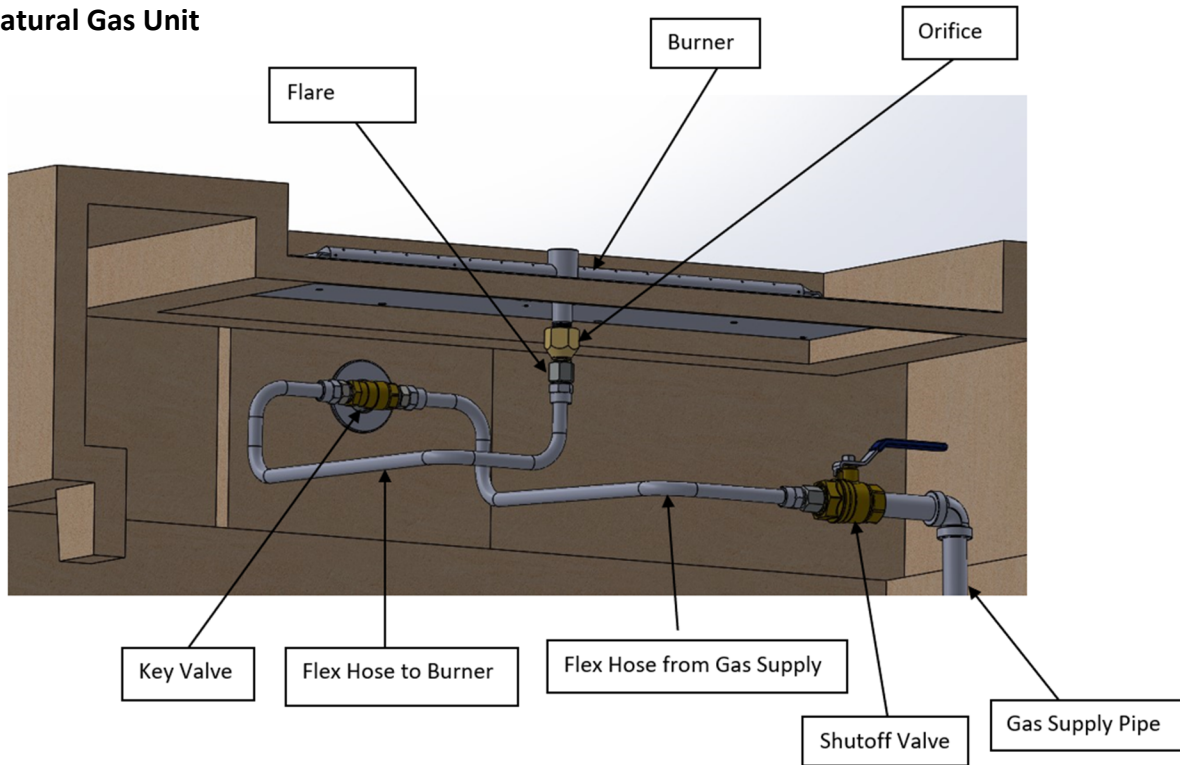

3.2.2 Propane Tank Unit

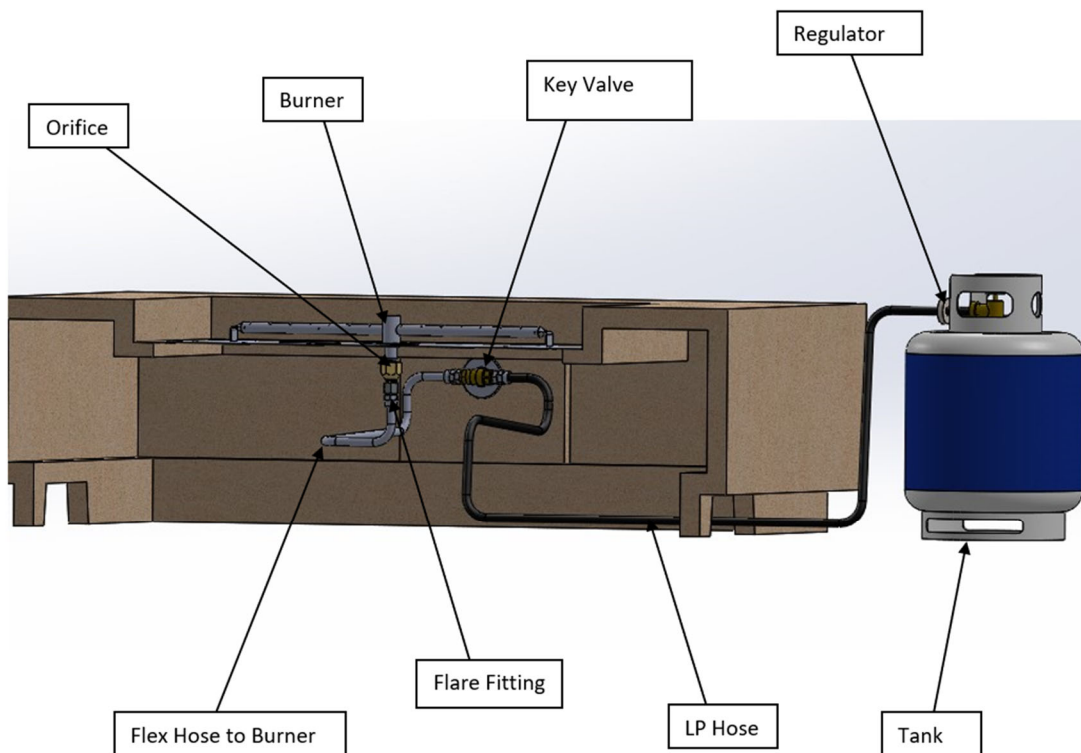

Section 4

Operation

4.1 Ignition

Refer to the section below according to which ignition system you purchased. An initial burner test should be done prior to filling the pan with media (rocks/glass/etc.)

4.1.1 Manual Light

You will need a fireplace lighter, do not use a match or cigarette lighter as they are much shorter and will light the fuel too close to the burner which may result in serious injury. Ignite your fireplace lighter and hold the tip close to the burner. Insert fire table key and turn it to the ON position to start gas flow to the burner- if you are using a propane tank unit, please note you will need to open the valve on your tank first. If your burner does not light within 5 seconds, turn key to the OFF position and wait 10 seconds before trying again. If the burner still does not light, call your local gas technician to determine if there is a problem. Once burner lights, immediately remove your hand and allow burner to operate for a few minutes before turning it off. Make sure the valve is properly closed every time you leave your fire feature unattended and remove key. For propane units, ensure that valve on tank is completely closed when fire feature is not use.

You are now ready to place the fire media onto the burner pan. Slowly pour media onto pan and spread evenly. Fire media should be sparsely spread out enough to cover pan. Only use the recommended amount of media in your unit (the amount provided), overfilling may result in smaller flame and gas buildup which may cause an explosion. Fresh air must be able to pass through the unit. Do not block or obstruct any vents on lower and upper parts of the fire feature. These are designed to ensure proper combustion and ensure no buildup of residual gases within the unit.

4.1.2 Battery Ignition *only available for LP Units

Find the panel on the side of your unit, the knob should be at the 12:00 position. This type of ignition takes one AA battery (not included). To insert battery, turn the black battery receptacle to the left of the knob counter-clockwise until it unscrews and comes off. Insert battery and carefully place receptacle knob back in position and screw back on. You may need to apply light pressure but do not overtighten as it may damage the knob and threads.

To ignite unit, ensure knob is in the 12:00 position to start. Push the knob inward and turn clockwise to the 6:00 position. You should hear the igniter sparking and the gas should ignite. Continue to push knob inward until burner lights, wait a few seconds and release knob. If the flame does not stay lit, push the knob back in and allow spark to reignite. If you do not hear the igniter sparking, your battery may be drained and will require replacement.

Regulate the flame by turning the knob clockwise until it is to your liking. The knob will not go past the 9:00 position. If the flames are still too low or too high, have the pressure regulator checked for proper

operation. Push knob inward and turn counter clockwise all the way back to the 12:00 starting position. If the knob does not turn the system off, contact your gas professional to replace gas valve. Only use factory approved parts for replacement. Once burner lights, immediately remove your hand and allow burner to operate for a few minutes before turning the knob all the way back to the 12:00/off position.

You are now ready to place the fire media onto the burner pan. Slowly pour media onto pan and spread evenly. Fire media should be sparsely spread out enough to cover pan. Only use the recommended amount of media in your unit (the amount provided), overfilling may result in smaller flame and gas buildup which may cause an explosion. Fresh air must be able to pass through the unit. Do not block or obstruct any vents on lower and upper parts of the fire feature. These are designed to ensure proper combustion and ensure no buildup of residual gases within the unit.

4.1.3 Electronic Ignition

Prism Hardscapes offers a separate installation guide for the Electronic PH-Ignite System. All other electronic system guides must be requested from their corresponding manufacturers.

 CAUTION: Open flames will ignite combustible materials such as clothing, fabric, hair, etc. which may result in serious injury, property damage and/or death. Be cautious of the open flames while burner is lit.

4.2 Adjustment

Allow the fire feature and media to cool down before moving or adjusting. This may take from 30 minutes to 1 hour depending on the size of the fire feature. Any shifting of fire media or feature should be done after the entire unit has cooled. Also prior to movement, ensure that all gas valves are completely closed and disconnected.

Refer to Section 1.4 for instructions on how to safely move your unit.

Section 5

Troubleshooting

Refer to the section below according to which Gas Type you purchased.

BURNER WILL NOT LIGHT

Possible Cause	How to Fix
Air in Gas Line	If newly installed, it may take several attempts to purge air from line.
Debris in Gas Line	Confirm gas line is clear and free of obstruction (insulation, dirt, excess pipe sealer, water etc.). Clearing line of debris may require help from a professional.
Improper Gas Pressure	Liquid Propane Units: Check if tank is low or empty, may need to refill or replace. Natural Gas Units: Have a gas professional confirm gas pressure.

BURNER WILL NOT STAY LIT

Possible Cause	How to Fix
Improper Gas Pressure	Liquid Propane Units: Check if tank is low or empty, may need to be refilled or replaced. Natural Gas Units: Have a gas professional confirm gas pressure.
Improperly Applied Fire Media	Media may be too dense; media will need to be reduced and evenly spread.

NOISE

Note: Only use gas hose supplied by the manufacturer as they have been tested for noise.

Possible Cause	How to Fix
Gas Hose Restrictions	Remove any tight bends or kinks in gas supply hose.
Excessive Gas Flow	Check gas regulator and reset if not within factory recommendations (Refer to the subsection for your gas type in Section 3).

UNIT IS SMOKING

Possible Cause	How to Fix
Poor Fuel Quality	Liquid Propane Units: Inspect propane tank and hose, one or both may need to be refilled or replaced. Natural Gas Units: Contact local gas company.

Excessive Flame Blockage	Separate and spread media (rocks or glass) evenly to allow flames to spread and pass-through media more evenly.
Improper Air/Fuel Mixture	Remove any foreign items or other combustible materials from unit & check for proper orifice sizing.

BURNER FLAME IS TOO HIGH OR TOO LOW

Possible Cause	How to Fix
Incorrect Gas Supply Pressure	Liquid Propane Units: Inspect propane tank and hose, one or both may need to be refilled or replaced. Natural Gas Units: Contact local gas company.
Blocked burner ports or burner orifice	Clear burner ports and orifice of foreign particles or debris and wipe clean.
Improper Orifice Size	Verify burner orifice is the proper size for the fuel being used. Consult with factory by emailing tech-support@prismhardscapes.com .

UNIT PRODUCING UNWANTED ODORS

Possible Cause	How to Fix
Gas Leak	DO NOT OPERATE -Turn off key valve but leave gas source on/open. (The gas should be flowing through the hose up to the igniter valve) Inspect hose(s), check for any leaks at all connections and fittings by using soapy water checking for bubbles. If a leak is found, turn off gas immediately and consult factory about replacing damaged/defective component. If no leak is found: Liquid Propane Units: inspect propane tank for damage or defect, tank may need to be replaced. Natural Gas Units: contact local gas company to inspect.

COLOR FADING

Possible Cause	How to Fix
Exposure	Concrete Units: Purchase cement sealer at your local brick and mortar retailer and apply a coat to concrete areas every year. Wooden Units: Purchase IPE sealer at your local brick and mortar retailer and apply a coat to wood areas every year.

Section 6

Warranty

Prism Hardscapes LLC offers a 2-year limited warranty against manufacturer defects. Prism Hardscapes will repair or replace product which has been proven to be defective in workmanship and/or material. If unit is confirmed defective and is not repairable by a qualified Prism Hardscapes representative, the unit will be replaced FOB PRISM HARDSCAPES facility. The buyer must provide proof of purchase along with date of delivery to the end user and arrange shipping associated with the replacement of the unit. Prism Hardscapes will not be responsible for any defects resulting from misuse, user error, installation error, abuse, repair or alteration. The use of wood or fuels other than those specified for use with this unit by Prism Hardscapes will void warranty immediately. Under no circumstances will Prism Hardscapes be liable for incidentals or consequential damage resulting from defective products. This warranty is Prism Hardscapes' sole warranty, all others expressed or implied whether of merchantability, fitness of purpose or otherwise, are therefore disclaimed by Prism Hardscapes. Prism Hardscapes is not responsible for any injury or mishap related to misuse, abuse, or lack of judgment in choosing fire display locations.



We create visionary designs coupled with handcrafted processes.

11150 Business Circle, Cerritos, Ca 90703
www.prismhardscapes.com • Phone: (951) 600-1123 • Fax: (951) 600-1109