

retigo®

PERFECTION IN COOKING AND MORE...

Combi ovens **Blue Vision**

OPERATING MANUAL



 **READ THIS MANUAL BEFORE USE**

DESCRIPTION OF THE MOST COMMON SCREENS

A BASIC SCREEN

A1 16:54

A2 Manual cooking

A3 Easy cooking

A4 Last Ten

A5 Favourites Programs Extras

A6 Settings Cleaning Help

A7 A8

A9

A10

A11

A1	Current time
A2	Manual cooking setup
A3	Cooking with the assistance of Easy cooking
A4	Previously used programs/cooking process selection
A5	Selection from programs marked as Favourites
A6	User and service settings
A7	Active Cleaning automatic cleaning
A8	Selection from saved programs
A9	Main screen setup (User profiles)
A10	Special functions
A11	Help/instructions

B MANUAL MODE

Manual cooking

B1

B2

B3

B4

B5

B6

B7

B8

B9

B10

B1	Cooking chamber preheating
B2	Cooking mode selection
B3	Humidity selection
B4	Setting the time
B5	Setting the temperature
B6	Settings for other functions
B7	Step back
B8	Overview of program steps
B9	Temperature probe settings
B10	Start cooking

C PROGRAM DETAILS (QUICKVIEW)

Grilled whole Chicken

C1

C2

C3

C4

C5

C6

C7

C1	Option Preheat/Cool
C2	Step parameters
C3	Enter another program step
C4	Step back
C5	Chef's tips
C6	Enter/delete a program step
C7	Start cooking

D END OF COOKING

Manual cooking

Cooking process finished.

D1

D2

D3

D4

D5

D6

D1	Information about the selected mode/program for the cooking process
D2	Disable the sound signal
D3	Option to immediately extend the last cooking step
D4	Save the completed cooking process as a program
D5	Display power consumption during the cooking process
D6	Return to the last screen before pressing the START button

CONTENTS

FOREWORD	4
ABOUT THIS MANUAL	5
01 BASIC INFORMATION ON THE COMBI OVEN	7
1.1 USE: WHAT IT'S FOR.....	7
1.2 DESCRIPTION COMBI OVEN.....	7
1.3 OPTIONAL ACCESSORIES.....	7
1.4 CONTROLS: BASICS.....	8
02 SAFETY DURING USE	9
2.1 SAFE OPERATION.....	9
2.2 SAFETY EQUIPMENT.....	10
2.3 PROTECTIVE ELEMENTS OF THE COMBI OVEN.....	10
2.4 DANGEROUS LOCATIONS AND RESIDUAL HAZARDS.....	11
2.5 USING ACCESSORIES.....	13
03 CONTROLS	14
3.1 TOUCHSCREEN PANEL.....	14
3.2 OTHER BUTTONS.....	14
3.3 KEYBOARD.....	14
04 COOKING	15
4.1 MANUAL MODE.....	15
4.2 PROGRAMS.....	18
4.3 EASY COOKING.....	28
4.4 MULTITASKING.....	29
05 EXTRAS	30
5.1 LOW-TEMPERATURE BAKING.....	30
5.2 RACK TIMING.....	31
5.3 EXTRAS (FURTHER FUNCTIONS).....	34
06 HELP	35
07 SETTINGS	36
7.1 BASIC SETTINGS.....	36
7.2 PROFILES.....	42
08 MAINTENANCE	43
8.1 DAILY MAINTENANCE.....	43
8.2 WEEKLY MAINTENANCE.....	44
8.3 SIX-MONTH MAINTENANCE.....	46
8.4 MANUAL MAINTENANCE.....	46
09 AUTOMATIC CLEANING	47
9.1 AUTOMATIC CLEANING: WHAT YOU SHOULD KNOW.....	47
9.2 START CLEANING.....	48
10 TABLE OF ERROR MESSAGES	49
11 SERVICE LIFE, DECOMMISSIONING AND WARRANTY	51

FOREWORD

Dear customer,

Thank you for purchasing a product from Retigo s.r.o. We are a manufacturer and supplier of specialized professional culinary appliances with a long track record of success. We believe this appliance will help you bring your ideas to outstanding fruition in your daily work. With this appliance, you can produce meals of such quality that your customers will come back again and again.





We wish you great joy and success in using the BLUE VISION combi oven.

ABOUT THIS MANUAL

This manual will help you to easily understand how to operate the BLUE VISION combi oven and inform you about its options and capabilities.

SYMBOLS USED IN THIS MANUAL

In this manual, you will find symbols with the following meanings:

SYMBOL	MEANING
	These symbols mean "ATTENTION" and "WARNING". They inform you of things that may cause serious injury to the user and/or damage to the machine. Furthermore, they indicate an important instruction, feature, method or issue that must be followed or considered when operating or maintaining the appliance.
	This symbol indicates useful information related to the appliance or its accessories.
	This symbol is a reference to another chapter in the manual.
	It indicates other procedure options that you may, but do not necessarily have to, apply.



VALIDITY OF DOCUMENTATION

This manual is about RP type appliance and the following models:

ELECTRICAL MODELS

2E0623IA, 2E0611IA, 2E0611BA, 2E1011IA, 2E1011BA, 2E2011IA, 2E2011BA, 2E1221IA, 2E1221BA, 2E2021IA, 2E2021BA.

GAS MODELS

2G0611IA, 2G1011IA, 2G2011IA, 2G1221IA, 2G2021IA.

WHO IS THE MANUAL FOR?

This manual is intended for anyone who only comes into contact with the appliance during its maintenance or operation. These people must study the manual carefully before beginning any kind of work with the appliance.

IMPERATIVE

Study the manual carefully. The manual must be considered an inseparable part of the appliance. For this reason, store it for future use.

Follow its instructions exactly, not only to make using the appliance easier, but also to ensure its optimal use and long life.

Do not start the appliance unless you are thoroughly acquainted with all instructions, prohibitions and recommendations indicated in this manual, especially those in the chapter "Safety during use".

The illustrations in this manual may not always correspond to an actual appliance. Their purpose is to describe the main features of the appliance.



The complete technology documentation for the appliance can be found at the manufacturer's website.

WHEN IN DOUBT

In practice, unforeseeable situations frequently arise that cannot be included and described in this user manual. Therefore, when you're not sure what to do, always contact the manufacturer:

RETIGO s.r.o.

Rope 2310

756 61 Rožnov pod Radhoštěm

+420 571 665 511

INFO@RETIGO.CZ

WWW.RETIGO.CZ

If you have any questions or doubts, feel free to contact the trained professionals at the following telephone numbers:

PROFESSIONAL SALESPeOPLE:

+420 603 571 360

+420 604 568 562

PROFESSIONAL CHEFS:

+420,734,751,061

+420,727,867,220

PROFESSIONAL SERVICE TECHNICIANS:

+420 571 665 560

When contacting the manufacturer or trained professionals, please have your appliance's basic information ready. This can be found on the model plate – see the chapter "Appliance identification".



A detailed description of the data indicated on the model plate can be found in the paragraph "Appliance identification".

ORGANIZATION OF CUSTOMER DOCUMENTATION

The customer documentation is made of two parts:

- Transport and installation instructions
- Operating instructions

MAIN TOPICS IN THE TRANSPORT AND INSTALLATION INSTRUCTIONS

- **Basic information:** describes the functions and main parts of the appliance relevant to its installation
- **Safety:** describes safety and appropriate measures during installation
- **Transport:** contains the necessary information on moving the appliance and handling it at the installation site
- **Placement:** describes and specifies rules for selecting the installation site
- **Installation:** describes set-up of the appliance, making the electrical connections, connecting the gas (for gas models only), connecting the water and drain, and finally the start-up.
- **Decommissioning:** describes the necessary tasks for completing the appliance's life, including its disposal.
- **Technical data:** contains all dimensional sketches and connecting dimensions

MAIN TOPICS IN THE OPERATION INSTRUCTIONS

- **Basic information:** describes the functions and main parts of the appliance relevant to its installation
- **Safety:** describes safety and appropriate measures during installation
- **Controls:** describes the appliance's main controls
- **Software operation:** contains instructions for working with the control software when cooking, and using the special "Extras" functions for heat treatment. Also describes settings, data import and export and working with profiles.
- **Cleaning:** describes cleaning methods, work procedures and steps for cleaning and **the operator's handling of the appliance.**

Maintenance: contains the instructions, maintenance plan, and handling of the appliance during maintenance.

APPLIANCE IDENTIFICATION

The model plate is on the right side of the appliance at the bottom. The model plate lists the appliance manufacturer, technical data on the appliance and the CE mark, indicating that the product complies with all requirements of the standards ČSN, EN, IEC and government decrees.

Electrical models

A - Brand name

B - Model

2E – heat production method:

E – electrical

1221 – appliance size:
0623, 0611, 1011, 2011, 1221, 2021

I – is the steam creation method:

I – injection

B – boiler

A – method of fan motor control:

A – frequency converter

Z – no frequency converter

C – Electrical parameters



Gas models

A - Brand name

B - Model

2G – heat production method:

G – gas

0611 – appliance size: 0623, 0611, 1011, 2011, 1221, 2021

I – is the steam creation method:

I – injection

A – method of fan motor control:

A – frequency converter

Z – no frequency converter

C – Electrical parameters

D – Gas parameters

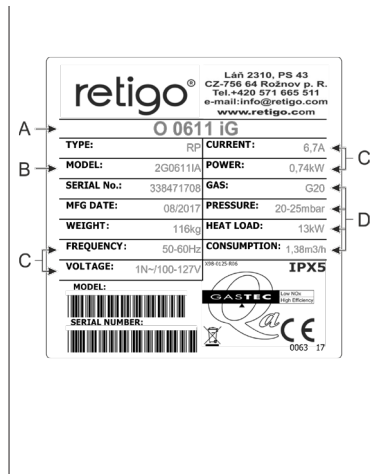

01 | BASIC INFORMATION ON THE COMBI OVEN

1.1 USE: WHAT IT'S FOR

The BLUE VISION combi oven is a universal appliance for preparing meals, including complete menus. It can be used for all types of food preparation based on heat, such as baking, frying, grilling, stewing, steaming, low-temperature overnight cooking, etc. The process is performed either in manual mode or in automatic mode using programs.

CORRECT USE OF THE COMBI OVEN

- The equipment can be used only for heat preparation of various types of food. This involves steam, hot air or a combination of the two. The food must always be placed in a standardized cooking container, baking trays dimensioned for baking or standard accessories exclusively from the manufacturer.
- The equipment used must be made of stainless steel, ceramics, heat-resistant plastic or enamelled steel.
- The combi oven is exclusively for professional use in the culinary field.

CORRECT USE OF THE COMBI OVEN

The following must not be placed inside the combi oven:

- no food in closed cans or packages
- no easily combustible objects with an ignition point lower than 260°C, such as easily combustible oils, fats or cloths
- no dry powder or granulate

1.2 DESCRIPTION COMBI OVEN

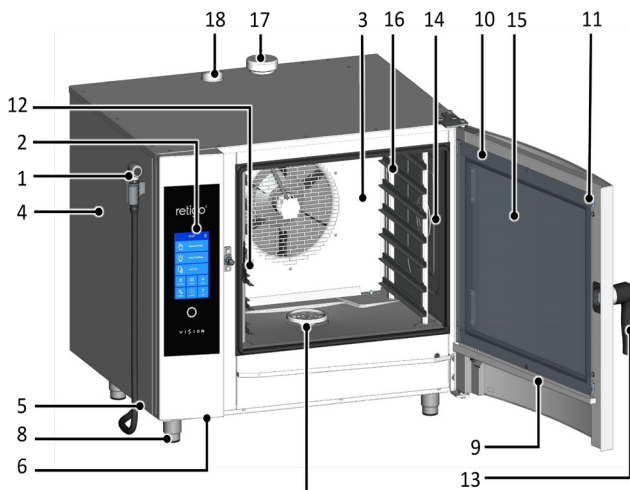

1. Self-winding hand shower – The standard configuration includes a shower hung on the left side of the machine.
2. Control panel
3. Detachable interior wall in front of fan
4. Side cover
5. Air and dust filter
6. USB connector
7. Drain cover
8. Height-adjustable legs
9. Condensation drip pan for the inner glass with automatic draining
10. Door with rounded exterior glass
11. Bolts for gripping the inner glass
12. Temperature probe
13. Door handle
14. Interior lighting
15. Openable inner glass of the door
16. Rail racks for cooking containers – On sizes 2011, 1221, 2021 the rail racks are substituted by a loading trolley
17. Excess steam venting flap
18. Venting chimney

7. Drain cover
8. Height-adjustable legs
9. Condensation drip pan for the inner glass with automatic draining
10. Door with rounded exterior glass
11. Bolts for gripping the inner glass
12. Temperature probe
13. Door handle
14. Interior lighting
15. Openable inner glass of the door
16. Rail racks for cooking containers – On sizes 2011, 1221, 2021 the rail racks are substituted by a loading trolley
17. Excess steam venting flap
18. Venting chimney



Any use of the combi oven including modifications to safety or operational components, is considered unintended use. The company accepts no liability for damages due to such use; the user bears all risk.

The user is also responsible for abiding by the conditions prescribed by the manufacturer for installation, operation and maintenance of the appliance, which must be maintained and repaired only by people familiar with it and instructed on its hazards.

1.3 OPTIONAL ACCESSORIES

COOKING CONTAINERS AND BAKING TRAYS

Cooking containers and baking trays serve not only for cooking and baking, but are also suitable for transporting, serving and storing the meals. They significantly contribute to higher work efficiency – when one plans their work properly, it is often unnecessary to transfer cooked or baked meals from one pan or tray to another.



Adhere to workplace safety codes when handling cooking containers, see 2. SAFETY DURING USE.

STANDS, LOADING TROLLEYS AND BRACKETS

Essential accessories for the combi oven include various stainless-steel stands, wall brackets (on model 623) and loading trolleys (on sizes 1011, 2011, 1221, 2021). Special equipment includes banquet baskets, trolleys and thermal covers used for serving meals.

VISION VENT HOOD

The Vision Vent condensation hood will enable you to comfortably maintain a pleasant climate in your kitchen thanks to strong exhaust performance and intelligent switching. Vision Vent is designed for the combi ovens RETIGO Vision 623, 611, 1011, 2011.

OIL GUN

This is a special device that saves up to 2/3 of the costs related to oil consumption for cooking, or when frying in the combi oven. Thanks to the narrow nozzle, one can perfectly coat the food with a very fine layer of oil, and maintain the beautiful colour of fried foods while keeping oil consumption to a minimum. Thanks to the exchangeable nozzle, the oil gun can be used for other viscous materials used in the food industry, such as chocolate.

VISION SMOKER

The Vision Smoker is a simple accessory compatible with all Retigo combi ovens. Thanks to simple controls, with the option to smoke up to three hours non-stop and simple maintenance, the Vision Smoker will enable you to liven up the meals you offer or expand the menu with smoked specialities.



When working with the oil gun and the Vision Smoker, adhere to workplace safety as described in the operating manuals for this appliance.

1.4 CONTROLS: BASICS

TURNING ON AND OFF

The appliance is permanently connected to the power grid and it is turned on and off by pressing an external main power switch. Its location is determined by the operator of the combi oven upon installation and you as the user must be informed of its placement. During ordinary use, it is enough just to put the combi oven into Standby mode by pressing the white circle under the display and then the Standby button.

OPENING AND CLOSING THE DOOR

The combi oven's door is equipped with a closing mechanism that allows right- or left-handed opening. Moving the lever to the side will release the door latch. Pull on the handle to open the door.

To close the door, push on the handle (by slamming). If you have an appliance with the loading trolley (2011, 1221, 2021) close the door and turn the door handle clockwise by 90°.

PREHEATING THE BOILER (combi ovens with a boiler)

When the combi oven is turned on, the boiler is automatically filled with water which is then heated. For this time, program start will be temporarily disabled in the "Steam" and "Hot air with steam" modes, until the boiler is fully heated. After this time, the combi oven will automatically continue running.

02 | SAFETY DURING USE

The combi oven cannot be operated without a certain amount of caution, alertness and common sense. Even though the combi oven has been designed and manufactured to meet all international safety standards, the user bears primary responsibility for his or her safety while operating the combi oven. The manufacturer bears no responsibility for personal injury, equipment damage or environmental damage caused by failure to operate the combi oven according to the manual or by failure to follow applicable safety regulations.

This chapter provides the most important information on working safely and protecting the health of the user and all others who come into contact with the combi oven or its accessories.

2.1 SAFE OPERATION

GENERALLY

- The combi oven is only to be used by personnel authorized, qualified and trained for operating it. Personnel who are not authorised to use and have not been trained in its operation must never be allowed to handle or maintain it, or to perform any activity contrary to its use. Such unprofessional activity may cause injury or damage the appliance.
- Get regular training on how to operate the combi oven. This prevents occupational injuries and damage to the combi oven.
- This combi oven is to be used only for food preparation and in compliance with the manual. Any other use is in conflict with its purpose and is considered dangerous.
- For safety reasons, do not remove the hard covers or try to get inside the combi oven – risk of injury by electrical shock. The device contains no components that the user can handle. Repair of any defects or maintenance beyond that described in this manual must be done by a qualified service technician.
- Do not install any heated appliance in the immediate area of the combi oven (such as fryers, grills, cookers, hot plates, etc.).



Detailed requirements for placing the appliance are given in the instructions for transport and installation.

- Do not work with the combi oven if you suffer from dizziness, fainting or other weakness or lack of concentration or if under the influence of drugs or alcohol!
- It is strictly forbidden to remove or damage the labels fastened to the combi oven.
- Only operate the combi oven in perfect working order. Do not make any changes to it.
- Follow the prescribed inspection plan, follow the instructions in the operating manual, adhere to generally applicable regulations for gas appliances.
- Do not place anything near the combi oven that you could trip over. Keep the workplace (including access ways) clean and tidy.

COMBI OVEN OPERATING ENVIRONMENT

- The permitted ambient temperature range is +4°C to +35°C.
- The environment must not be explosive or toxic.
- A fire extinguisher or an automatic fire extinguishing system must not be located directly above the combi oven.
- There must be no flammable materials, gasses or liquids located underneath or next to the combi oven.

BEFORE USING THE COMBI OVEN

- Before starting the appliance, it is absolutely necessary to learn the chapter “Safety during use”, along with this chapter.
- If you have any doubts about the combi oven’s installation, operation or safety, contact your supplier.
- If the electrical equipment is damaged in any way, arrange repairs immediately – never use a damaged combi oven.
- Do not block the combi oven’s vents with objects, and especially do not place cooking utensils, fabrics or other items on the appliance. Make sure that steam freely escapes from the vents at the top of the combi oven.
- Before using, check the combi oven’s cooking chamber. Remove all remaining food, cleaning agent residues or other objects, and thoroughly rinse the cooking area with a hand shower.
- Be sure not to sprinkle or spray water on the combi oven, and not to place objects filled with water on it.
- Do not place sources of open flame on or near the combi oven.

DURING USE OF THE COMBI OVEN

- Do not continue using the combi oven if you have the slightest doubt as to its safe operation or whether it is damaged. Turn it off immediately, unplug the power cable, shut off the water supply, and contact your supplier.
- If noise increases beyond the permitted limit while the while you are using the combi oven, stop the combi oven and fix the cause.
- Immediately report all faults to your superior, who must arrange for their repair.
- Do not leave the combi oven unattended while it is turned on, unless explicitly instructed to by the manual.
- Use only your fingers to operate the control panel buttons. Using sharp, pointed or other objects to operate the appliance voids the warranty.
- When working with the combi oven, be aware that cooking containers, cooking inserts and grates can be hot. The temperature of the external glass on the door may reach temperatures higher than 60°C. In all cases there exists a risk of burns.
- Hot steam is generated while the combi oven is running – when the door is opened, there is a risk of scalding, etc. When opening the door, especially during steam operations, always stand in such a way that you cannot be scalded by the steam escaping from the open door. Open the door only partially and do not open fully until the steam has escaped.
- If cooking containers are more than three-quarters filled with liquid, greater care must be taken when handling and removing them. When placing containers this full into the appliance, put them only in racks into which you can see. Otherwise, the user may be scalded. Take great care when removing hot cooking containers – whatever their content!
- Be especially careful when working with a combi oven (set of appliances) whose highest rack is 160 cm or higher above the ground. Here there is a risk that the cooking container may flip over and cause burns.
- Hot areas may form during the cooking process, especially on the cookware, grills and the inner side of the door. Use safety gloves whenever handling hot objects.
- If the combi oven is equipped with a loading trolley, then you must always brake the trolley when it has entered the appliance. When handling a full trolley, the cooking container locking mechanism must always be used (cooking containers are closed).
- When transporting cooking containers filled with a liquid, they must be covered with sealing lids. Otherwise, the user may be scalded.

- If the floor is very uneven, loading trolleys must not be used for entering or leaving the combi oven. Never leave the trolley handle inside a closed combi oven. This may break the combi oven's door. Do not pull the loading trolley without the handle designed for this purpose. Otherwise, burns may occur.
- When using banquet trolleys, always make sure that the plates are correctly seated on the stands.
- For cleaning the trolleys, always use the automatic cleaning program (if available). Otherwise, use cleaning products designed for semi-automatic cleaning. It is not permitted to use the combi oven without the loading trolley for standard work and automatic cleaning!

AFTER YOU HAVE FINISHED WORKING WITH THE COMBI OVEN

- Clean and service the combi oven only when it is cold!
- Remove solid pieces of food by taking them out of the cooking chamber – never cleaning them down the combi oven's drain.
- Cleaning and descaling agents are to be used only according to the instructions in this manual and in compliance with the instructions for the individual agent.
- After work (e.g. overnight), leave the combi oven's door ajar.
- When the combi oven is not used for an extended time, shut off the water and power supply.

CLEANING

- Use extra caution when handling cleaning agents. Contact with cleaning agents and their fumes pose a hazard of burns or irritation to skin, eyes and respiratory organs.
- When handling cleaning agents, wear safety equipment.
- When dosing powdered cleaning agents, be extra cautious that they are not inhaled and do not come into contact with eyes and mucous membranes.

2.2 SAFETY EQUIPMENT

When operating the combi oven, it is also necessary to wear the right clothes and use personal protection gear. Clothing, shoes and protective gear must comply with national safety requirements for your type of work. Especially do not forget to use these important items:



When working with the combi oven, we do not recommend wearing:

- Scarves, neck ties, chains, watches, bracelets, keys, rings or other metal objects, or working with an inappropriate bandage on.
- Electrical components such as heart pacemakers, watches, credit cards, etc., or other items with magnetic recording media.
- Long, loose hair. Secure long hair with an appropriate head covering.

2.3 PROTECTIVE ELEMENTS OF THE COMBI OVEN

The combi oven is equipped with safety elements that make it safer to operate. Here is a list of the most important ones:

1. External main switch
2. External covers
3. Protective temperature limiter
4. Control panel
5. Door with magnetic lock
6. Ventilation position of the appliance door
7. Internal wall

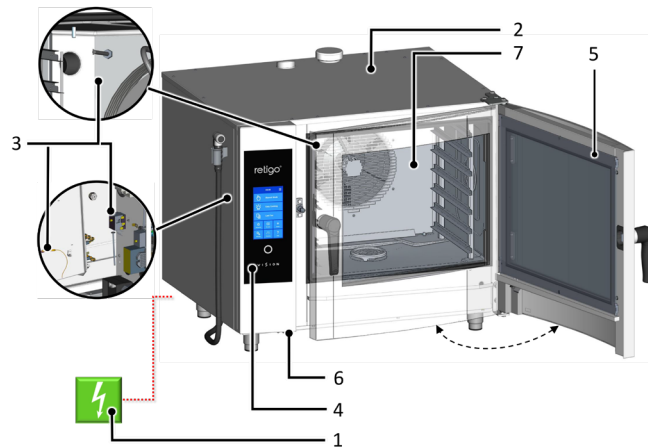

⚠
None of the elements below are intended to be removed by the operator. It can be removed for inspection, maintenance or repair only by a person qualified for the task.

EXTERNAL MAIN SWITCH

The combi oven is designed for permanent connection to the power grid. The power supply is connected and disconnected using an external main switch. The switch is used for turning the appliance on and off (when starting operation, making repairs, installing, and also in emergencies). The external main switch must be easily accessible at all times!

⚠
It is forbidden to tamper with safety circuits, to remove the side covers, or to perform any unauthorized changes that alter the reliability and safety of these circuits.

EXTERNAL COVERS

All removable covers are firmly connected to the combi oven, so they can be removed only with tools. Covers prevent unintentionally touching parts carrying electricity. Always check whether the covers are in place.

PROTECTIVE TEMPERATURE LIMITER

Protective temperature limiters are located in the cooking chamber, boiler and electrical panel. When there is excessive temperature, these elements activate and turn off the appliance.

If a protective limiter fails, an error code displays accompanied by an audible signal.

CONTROL PANEL

The control panel is located outside the area prone to high temperatures and makes it possible to quickly turn off the appliance using the STOP button. The display also shows malfunctions.

The control panel is securely fixed to the front control panel and prevents unintentionally touching conductive parts. It can be removed only with a tool.

DOOR WITH MAGNETIC LOCK

The moment the door opens, the heat automatically shuts off and the fan quickly stops to limit the escape of steam from the cooking chamber. To protect against steam scalding, first open the door slightly and wait a while before opening it fully. To close the door, push on the handle (by slamming). If you have a machine with the loading trolley (2011, 1221, 2021) close the door and turn the door handle clockwise by 90°.

If the door is not closed properly and the appliance is in the **Start** mode, a "close door" prompt will appear.

VENTILATION POSITION OF THE APPLIANCE DOOR

To protect against steam scalding, the doors can first be opened slightly. In this position, the doors remain partly locked. Once steam stops coming out of the cooking chamber, the door can be opened completely.

INTERNAL WALL

It is always located inside the cooking chamber in front of the fan so as to prevent striking against the fan's rotating wheel. The internal wall can only be removed with tools.



Under no circumstances should you remove any safety or protective element of the combi oven! Do not make any changes to it without the permission of the manufacturer.

2.4 DANGEROUS LOCATIONS AND RESIDUAL HAZARDS

The appliance is designed so that when properly used in perfect technical condition, it poses no danger to the operator or surroundings. Nonetheless, during its operation, situations may arise that could be dangerous if the user is not aware of them. These are called residual hazards — those that remain even after all preventive and protective measures have been considered and implemented. Spot these risks early and avoid them.

Dangerous locations, types of hazards and their effects.

COOKING CHAMBER

While it works, the combi oven creates high-temperature steam in the cooking chamber.



- Burning hazard from hot places throughout the chamber.
- Burning hazard from side handles (racks) of cooking containers and other accessories used when heating food.
- Scalding hazard from hot steam escaping the cooking chamber when the appliance door is opened.

FAN

In the combi oven's cooking chamber, behind the internal wall, there are one or more circulating fan wheels.



- Hand injury hazard from careless handling in the cooking chamber behind the inside wall when it is not properly installed in place.
- Hand injury hazard from careless handling in the cooking chamber behind the inside wall during cleaning or maintenance.

DOOR

The inside of the door and especially the internal glass heat up to a high temperature when the combi oven is working. The combi oven also creates hot steam that escapes when the door of the cooking chamber is opened.



- Risk of burns from the inside of the door when opening the door during or after the cooking process.
- Risk of scalding by hot steam and fumes when opening the appliance, and especially when the top of the door is at face level, as it is with sets of two combi ovens.

UPPER COVER OF APPLIANCE

Never cover the appliance or place on it any objects that may catch fire. Your appliance is not a storage shelf!

Be careful and use safety gloves.



- Risk of burns during the cooking process.
- Fire hazard if the cover is covered or if flammable materials are on the cover during the cooking process.

COOKING CONTAINERS

Never handle containers above eye level that contain hot liquids or hot liquid food, and always use safety gloves.



- Risk of burns during improper handling of hot accessories when removing them from the appliance after cooking.

FLAP AND CHIMNEY

Do not place any part of the body above these parts and always use safety gear (gloves, safety glasses, etc.).



- Burning hazard from steam escaping during the cooking process.

EXHAUST DISCHARGE

Do not place any part of the body above these parts and always use safety gear (gloves, safety glasses, etc.).



- Burning hazard from hot flue gases escaping during the cooking process.

MANUAL SHOWER

- Scalding hazard from hot steam or hot fat when spraying a hot cooking chamber.
- Do not use the hand shower to cool the cooking chamber or for cleaning if its temperature is higher than 90°C.
- Scalding hazard from hot fat and steam when water splashes into hot fat.
- Do not injection water directly into hot fat – this may cause spattering and intense heat creation.

Residual risks

To further reduce risks and to ensure the effectiveness of safety protection we provide information about residual risks. To remove them, we establish the following technical and organizational measures for implementation by the user. These are intended to overcome the respective hazards.

ELECTRICAL CURRENT

All of the combi oven's electrical components are powered by potentially fatal current. The power supply terminals and other electrical components remain under voltage even when the combi oven is turned off.



- Injury hazard from electrical current from conductive parts!

However, access to the area with electrical components is only possible after removing a rigid cover. As the user, you are not authorised to service the appliance's electrical components. There is only a hazard if electrical supply cable is damaged, such as when inappropriately placed, twisted, pinched, weighed down, etc. Moreover, if the appliance moves by itself on the wheeled frame, this may break the supply cable.



- When operating the appliance, always lock the wheels with the parking brake!

If there is any damage to the electrical equipment, it is necessary to stop using the combi oven immediately and arrange immediate repair by authorized service personnel.

If it is not necessary to have the combi oven under live current, disconnect the main power supply connection by turning off the main power switch.

MECHANICAL PARTS

Hazards arise only when the combi oven has been installed on the wheeled frame or has been installed incorrectly (such as on a strong tilt, not anchored on a slippery or unstable surface, etc.), and its unexpected movements may cause crushing or pinching when it loses stability.



- If you think that the appliance is incorrectly installed in regard to stability, do not continue working, and immediately contact the owner to check the installation.
- Injury hazards from moving parts occur in situations where the cooking chamber is cooled with the doors open – “Cool down” function, the internal wall in front of the fan is missing, so that the fan wheel is freely accessible.

When handling the combi oven, adhere to the relevant regulations for tying loads and the handling of lifting equipment.



- Make sure that the internal wall is always in its place and properly secured against loosening!
- Risk of hand injury may occur when sliding or pull out the loading trolley or loading basket.
- When handling loading accessories, always use the handle provided for the purpose.

HIGH TEMPERATURE

During the cooking process, the appliance's interior heats to a high temperature, including containers and food that have been inserted, and after the doors of the cooking chamber are opened, this heat escapes to its surrounding. For this reason, there is risk of burning or scalding when working with or near the combi oven.



- Risk of burns from hot surfaces mainly occurs in the entire cooking chamber, including the inside of the door, and on all parts that are or have been inside during cooking, such as cooking containers, handles of cooking containers and grates.
- Wear the prescribed safety clothing, especially safety gloves!
- A scalding hazard from hot steam can occur when water is sprayed into the warmed-up cooking chamber or the doors are open during “Cool down” function.
- Step far enough away from the appliance, and do not injection water into the warmed-up cooking chamber for fast cooling or when rinsing with the hand shower!



- A scalding hazard occurs when water is sprayed into the appliance when it holds a container with hot fat.
- Do not injection water into hot fat!
- There is also a water scalding hazard during improper handling of the cooking containers, when using cooking containers of inappropriate dimensions, and when using a plate of inappropriate dimensions in relation to the handle of the banquet trolley plate handles.
- When handling containers that contain hot liquids or hot liquid food, use extra caution and always use safety gloves.

DETERGENT

When detergents are used, there is a risk of burning or irritation to the skin, eyes and respiratory organs from direct contact with the cleaning agent or its fumes.



- Avoid direct contact with detergents. If there is risk of contact, use safety gloves.
- When dosing, be especially careful not to inhale the detergent.
- During full automatic cleaning, do not open the appliance door unless prompted by the software — there is danger of inhaling detergent fumes or splashing skin and eyes.

FOOD CONTAMINATION

When cleaning or descaling agents are used wrong, the area around the combi oven, where food is usually prepared, can become contaminated. Then they may become contaminated.



- Make sure the work surface has not been splashed with detergent or descaler!
- Do not place empty containers on the work surface — the food may get contaminated!

GAS

Gas combi ovens also pose these risks:



- Risk of explosion if the gas line is defective or leaky.
- There is a risk of an oxygen shortage in the kitchen if the burner is improperly adjusted, and of a lack of air in the kitchen if the exhaust line is leaky.
- Follow the prescribed inspection plan, follow the instructions in the manual, adhere to generally applicable regulations for gas appliances.

WATER

If the appliance and its wheeled cart begin making undesired movements, this may break or damage the water feed, and escaping water may cause slips and falls.



- Before operation, always check that the wheels are locked with the parking brake! Keep the combi oven's work area and surroundings clean and dry!

2.5 USING ACCESSORIES

TEMPERATURE PROBE

When using the temperature probe, adhere to the following:

- Use the probe only for insertion into food.
- Do not insert the probe into frozen food. This can break it!
- Never forcefully bend the temperature probe's power cable.
- Never pull the probe out of the food by the cable.
- Place the temperature probe into the food in such a way that it does not lean against the door glass.
- The temperature probe may be hot — use protective gloves.
- Pull the temperature probe out of the food before removing the food from the appliance and place it into the probe holder.
- When the probe is not in use, keep it in the probe holder.

- Never leave the temperature probe hanging outside the cooking chamber — the door may close on it and damage it.

HAND SHOWER

When using the hand shower, adhere to the following:

- The hand shower may only be used for cleaning the cooking chamber.
- The hand shower works for only two minutes after the door is open. Then it turns off automatically.
- Never use the hand shower when the combi oven is hot. Allow it to cool down to under 65 °C.
- Never use the hand shower for cooling down the cooking chamber when the temperature inside the cooking chamber is higher than 90 °C — this may destroy the inner glass of the door and cause deformation of the cooking chamber!
- Never spray water from the hand shower onto hot door glass — this can destroy it!
- After use, always place the hand shower in its holder.

03 | CONTROLS

3.1 TOUCHSCREEN PANEL

The meanings of buttons (icons) found on the most common screens is provided on figures A, B, C, D. The basic button functions are selected simply by gently tapping on the icon on the panel. The extended functions are then activated by pressing and holding down the button for longer than 2 seconds.

FREQUENTLY RECURRING BUTTONS

The system has buttons that are common for the individual modes and functions of the combi oven. Their meanings are as follows:

	Back	Press the button to go to the next step.
	Ok	Press the symbol to confirm your selection.
	Start	Press to start the desired cooking process, cleaning, etc.
	Stop	Press to stop the current cooking process and display it on screen D.

3.2 OTHER BUTTONS

	The Vision button serves to: a) switch to Multitasking mode 4/4.4 b) turn on the control system c) put the combi oven into standby mode. d) screen calibration mode after holding down the button for more than 2 seconds
	Pressing the symbol will display the main screen (A).
	When pressed, the control system will go into sleep mode and the screen will turn off. The system is woken up by pressing the Vision button.
	Press it to call up a quick hint for the individual control system functions.
	Pressing turns on the continuous lighting in the cooking chamber and pressing again turns it off. Lighting then goes on only when the cooking chamber door is opened.
	Press to show or hide further lines that offer extended combi oven functions.

3.3 KEYBOARD

The system also has keyboards. Their control is the same in all modes and functions of the combi oven.

BASIC NUMERICAL KEYPAD

For entering values

		Delete values.
		Quick correction of values.
		Non-stop time, non-stop performance of a function.

EXTENDED ALPHANUMERICAL KEYBOARD

For entering letters, symbols and numbers.

		Change case.
		Toggle between a keyboard with letters and a keyboard with numbers/symbols.
		Delete characters.
		Space bar.
		Keyboard options. Select language and style (QUERTY-QUERTZ).
		Toggle between a keyboard with numbers/symbols and a keyboard with letters.
		Delete characters.
		Space bar.

04 | COOKING

4.1 MANUAL MODE

This option is utilised by users, who want to have the cooking process parameters set exactly according to their requirements. Set the cooking parameters manually according to your own discretion and experience.

Pressing option A2 will display the **Manual mode** (B).

B1 COOKING CHAMBER PREHEATING

Off. 

On. 

The value below the symbol is set at the factory to 15°C higher than the cooking process temperature you have set (B5). This means that whenever you manually set the cooking process temperature with active preheating, the preheating temperature automatically increases by 15°C. The only exception is Steaming mode, in which the preheating temperature corresponds to the set process temperature.

i The increase value can be changed in the user settings (07 SETTINGS/7.1/ Cooking/Preheat/Temperature increase).

The preheat value can also be changed manually in a range from 30°C to 300°C after pressing and holding the preheat symbol. This allows creation of a program containing an individual step with automatic preheating with a precise temperature value. After it is started, if the temperature in the cooking chamber is significantly lower, it is possible to open the door without stopping the fan from turning. The fan will continue at the standard RPM and blow hot air out of the chamber. As soon as the temperature in the chamber reaches the set preheat temperature, the fan automatically stops.

B2 COOKING MODE SELECTION

HOT AIR 
 Substitutes for baking in a pan, in an oven, frying in a deep fryer, etc.
 Temperature range: 30-300° C

HOT AIR WITH STEAM (COMBINATION) 
 Substitutes for baking requiring basting or procedures, where the meal requires a certain humidity percentage, while simultaneously cooking it with hot air, etc.

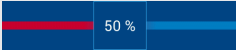
The amount of steam in the cooking chamber can be set by moving the slider or tapping on the percentage value and entering it using the numerical keypad. 
 Temperature range: 30-300 °C

STEAMING 
 Substitutes for cooking in water.
 Temperature range: 30-130 °C

WARMING ON THE PLATE 
 For warming cooled food.
 Temperature range: 80-180 °C

GOLDEN TOUCH 
 Controlled food completion through high-temperature baking for outstanding colour and crispness.
 Temperature range: 180-250 °C

COOK and HOLD 
 After cooking is over, automatically changes the system phase to maintain food at 75°C. If the cooking process is finished according to the temperature at the centre of the food, and that is lower than 75°C, for the maintenance phase, the combi oven automatically sets the temperature at the centre when cooking ended.



B3 HUMIDITY CONTROL 

HOT AIR mode is shown by a flap symbol, and moving or tapping the scroll bar allows the following settings:

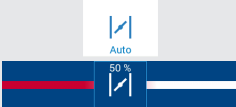
Fully open flap valve; continuous venting of humidity from the cooking chamber. 

The system controls the opening/closing of the flap valve itself according to the set percentage of humidity. 

Fully closed flap valve; all the humidity stays in the cooking chamber.

In Combination mode, humidity is displayed as a percentage, which can be changed by moving the scroll bar in a range from 0% to 100%.



NOTE:
In STEAMING mode, the humidity is a fixed setting and cannot be changed.



B4 SETTING THE TIME
Set the cooking process time.
Time range: 00:01-23:59 (h:m)



B5 COOKING PROCESS TEMPERATURE
Set the cooking process temperature.
The temperature range depends on the used cooking mode.



B6 SETTINGS FOR OTHER FUNCTIONS



FAN SPEED
Set seven fan speeds.

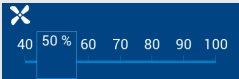

FAN TIME CONTROL
The fan will rotate only:
- when the heating elements are on
- for 10 seconds when idle for longer than 2 minutes.



NOTE ON THE STEP
Allows text comments to be written, which will display upon transition to the relevant program step. The comments are accompanied by an audible signal.



B8 OVERVIEW OF PROGRAM STEPS
Shows an overview of all the set cooking parameters. Enables the changing of settings, adding another step or reading of chef's tips. For a detailed description, see screen C.



B9 TEMPERATURE PROBE
Setting the probe temperature
Allows the cooking process to be controlled by setting the final temperature at the centre of the food.
Temperature range: 30-110 °C



DELTA T
Allows a constant difference to be set between the temperature at the centre and that in the cooking chamber.
Temperature range: 20-70 °C



4.1.1 Cooking with manual settings

1 GO TO MANUAL MODE



2 SELECT AND EDIT THE PARAMETERS B1 TO B9 AS NECESSARY.



2.1 OPTION: ADD A STEP

Press



Press



Select and edit the parameters B1 to B9 as necessary.



To add another step, repeat the procedure from point 2.1

2.2 OPTION: SAVE AS AUTOMATIC START

If you want the program to automatically start repeatedly at a specific day and time, proceed according to chapter 4.2.10.

3 START THE COOKING PROCESS BY PRESSING



4 AT THE END OF THE COOKING PROCESS, SELECT AN ACTION WITH WHICH TO CONTINUE (screen D)

4.1 OPTION: EXTEND THE TIME OF THE LAST COOKING STEP

 Press



4.2 OPTION: SAVE THE PROCEDURE TO THE PROGRAMS

 Press

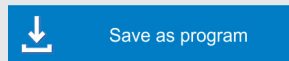

Select the folder for storing the new program.

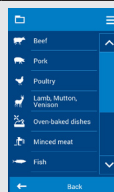

Enter the name of the program

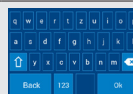

Press



You can add a pictogram/image as you wish  4/4.2.5, point 4.1

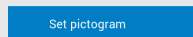

Tick this option to add the program to the favourite programs section.

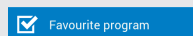

In the QuickView, you can check all of the cooking program's steps.

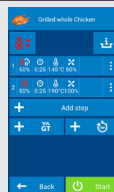

4.3 OPTION: OVERVIEW OF THE COOKING PROCESS STATISTICS

 Press



4.4 OPTION: TURN OFF THE SOUND SIGNAL

 Press



4.5 OPTION: RETURN TO THE MAIN SCREEN



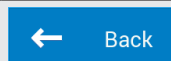

 Press













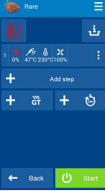

4.2 PROGRAMS

The Program mode enables the combi oven to be used to the maximum extent possible, with ultimate control comfort ensuring that the final products are repeatedly of the highest quality.





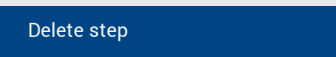















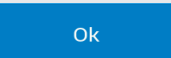

PROGRAM MODE SYMBOL SYSTEM

 Beef	Main category according to meal type (category).
 Steak	Subcategory with more programs
 Rare	Program
	Newly created program with no pictogram assigned.

4.2.1 Cooking according to a program

1	ENTER PROGRAMS (option A8)	
2	SELECT A PROGRAM CATEGORY	
3	SELECT EDIT MEAL (PROGRAM)	
4	PROGRAM PREVIEW APPEARS (QUICKVIEW) All program steps display on a single screen with the option to edit or add further steps.	
4.1	OPTION: EDIT PARAMETERS  Select and edit the parameters B1 to B9 as necessary.	
4.2	OPTION: ADD A STEP  Press	
	To add another step, repeat the procedure from point 3.1	
4.3	OPTION: STARTING THE PROGRAM FROM THE SELECTED STEP  Press	
	Select	
4.4	OPTION: DELETE STEP At steps that you wish to delete, press	
	Select	
4.5	OPTION: SAVE AS AUTOMATIC START  If you want the program to automatically start repeatedly at a specific day and time, proceed according to chapter 4.2.10.	
5	START THE COOKING PROCESS BY PRESSING	
6	AT THE END OF THE COOKING PROCESS, SELECT AN ACTION WITH WHICH TO CONTINUE (screen D)	

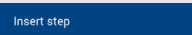
4.2.2 Creating a new program

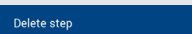
<p>1 ENTER THE PROGRAMS</p>	
<p>2 SELECT A PROGRAM CATEGORY IN WHICH YOU WISH TO CREATE A NEW PROGRAM</p>	
<p>3 PRESS</p>	
<p>4 PRESS</p>	
<p>5 ENTER THE NAME OF THE PROGRAM</p>	
<p>5.1 OPTION: CHANGE PICTOGRAM  You may assign any pictogram/picture to the program  4/4.2.5, point 4.1</p>	
<p>5.2 OPTION: FAVOURITE PROGRAM  Tick this option to add the program to the favourite programs section. You will find programs marked as favourites under button A5</p>	 
<p>6 PRESS</p>	
<p>7 PROGRAM DETAILS WILL BE SHOWN (screen C)</p>	
<p>7.1 OPTION: ADDING PROGRAM STEPS  Edit the parameters B1 to B9 as required</p> <p>Press</p>	  
<p>7.2 OPTION: STEP PARAMETER SETTINGS  Press the step that you wish to edit</p> <p>Edit the parameters B1 to B9 as required</p> <p>Press</p>	  
<p>7.3 OPTION: INSERT A STEP  Press at the step above which you wish to insert a new step</p> <p>To insert it, select button</p>	 
<p>7.4 OPTION: DELETE STEP  At steps that you wish to delete, press</p> <p>To delete it, select button</p>	 

7.5 OPTION: ADDING CHEF TIPS OR INFORMATION TO THE PROGRAM

	Press	
	Enter information or program tips	
	Press	
8	PRESS	
9	THE NEW PROGRAM IS SAVED	
10	RETURN TO PROGRAM	

4.2.3 Editing a saved program

1	ENTER THE PROGRAMS	
2	SELECT A PROGRAM CATEGORY IN WHICH YOU WISH TO EDIT A PROGRAM	
3	SELECT THE PROGRAM YOU WISH TO EDIT AND HOLD LONGER THAN 2 SECONDS	
4	FROM THE MENU, SELECT THE MODIFICATION THAT YOU WISH TO MAKE	

4.1 OPTION: EDIT A PROGRAM
 It is possible to change the name of the program, parameter settings, add or delete a step. The procedure is similar to creating a new program.

4.2 OPTION: RENAME A PROGRAM
 Rename a program using the alphanumerical keyboard.

4.3 OPTION: ADD TO FAVOURITES
 Allows a program to be added to Favourites. Programs marked in this way can be found under button A5.

4.4 OPTION: REMOVE FROM FAVOURITES
 If you have previously added the program to Favourites, its selection option will display.

4.5 OPTION: DELETE A PROGRAM
 Permanently delete a program after confirming

4.6 OPTION: ADD TO THE MAIN SCREEN
 Add a program to the main screen for fast start-up.
ATTENTION: If you are working in the standard default user profile, you must save the changes as a new profile. The default profile cannot be changed.

Information appears on the display.	
Enter a name for the new profile.	
Press	

The program will be added to all buttons on the main screen. If the button is outside the screen area, use the scroll bar on the right side of the display.
 The position and size of the buttons can be changed as necessary
 6/6.2.2

4.2.4 Creating a program on a PC and loading it on to the combi oven from a USB drive.



Programs for the combi oven can also be created and edited using your computer in a special software program **VisionCombi software**.

If you wish to load your own program created on your computer onto the combi oven using a USB drive, enter the **Settings** menu and select **USB drive**. Further details are available in chapter **6/6.1, point 4**.

The VisionCombi software is available at the manufacturer's website.

4.2.5 Creating a new program category

1 ENTER THE PROGRAMS



2 PRESS



3 SELECT



4 ENTER THE NAME OF THE CATEGORY

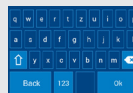

4.1 OPTION: ADD A PICTOGRAM



Press



Select the source of the pictogram

For an icon from the internal disk of the combi oven, press



Choose the appropriate program from the internal combi oven disk or save your own pictogram using the USB drive, **6/7.1**.

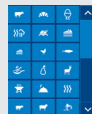

Press

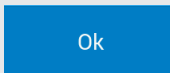

Now the new category is created and saved.

For a pictogram from a USB, connect your USB and press



Select a pictogram and press

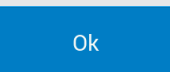

Now the new category is created and saved.

4.2 OPTION: CATEGORY WITHOUT A PICTOGRAM







After entering the name of the program category, press



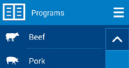
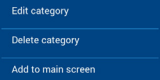
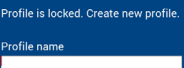











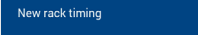

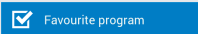

Now the new category is created and saved.

4.2.6 Editing a program category

<p>1 ENTER THE PROGRAMS</p>	
<p>2 SELECT THE CATEGORY YOU WISH TO EDIT AND HOLD IT DOWN FOR LONGER THAN 2 SECONDS.</p>	
<p>3 FROM THE MENU, SELECT THE MODIFICATION THAT YOU WISH TO MAKE</p>	
<p>3.1 EDITING A CATEGORY For editing the name of a category and changing or removing a pictogram.</p>	
<p>3.2 OPTION: DELETE A CATEGORY After confirmation, permanently delete the group.</p>	
<p>3.3 OPTION: ADD TO THE MAIN SCREEN Add a category to the main screen for fast start-up. Press to place the category on the main screen. ATTENTION: If you are working in the standard default user profile, you must save the changes as a new profile. The default profile cannot be changed.</p>	
<p>Information appears on the display.</p>	
<p>Enter a name for the new profile.</p>	
<p>Press</p>	

i The category will be added to all buttons on the main screen. If the button is outside the screen area, use the scroll bar on the right side of the display.
 The position and size of the buttons can be changed as necessary
 6/6.2.2

4.2.7 Creating a new Rack timing program

1	ENTER THE PROGRAMS	
2	PRESS	
3	PRESS	
4	ENTER THE NAME OF THE TIMING PROGRAM	
4.1	OPTION: CHANGE PICTOGRAM You may assign any pictogram/picture to the program   4/4.2.5, point 4.1	
4.2	OPTION: FAVOURITE PROGRAM Tick this option to add the program to the favourite programs section.  4/4.2.2, point 5.2	
5	PRESS	
6	TIMING PROGRAM DETAILS WILL BE SHOWN Follow  5/5.2.1, point 8 - 13.2.	
7	PRESS	
	The new Timing program is saved	
	Other work options with Rack timing programs (edit, delete, rename, add to the main screen) are the same as in chapter  4.2.3. Cooking with rack timing programs is identical to chapter  5/5.2.	

4.2.8 Last ten

 In the section Last ten, the last ten used cooking methods are stored chronologically. Here, you will also find manually set cooking, program assisted cooking, cooking using rack timing programs, and cooking using Easy cooking.

1	ENTER THE LAST TEN SECTION (option A4)	
2	SELECT A PROGRAM	
3	PROGRAM PREVIEW APPEARS (QUICKVIEW) All program steps display on a single screen with the option to edit or add further steps.	
3.1	OPTION: EDIT PROGRAM  From the selected program, you can edit parameters B1 to B9 or steps according to  4.2.2/7.1 to 7.4	
4	START THE COOKING PROCESS BY PRESSING	
5	AT THE END OF THE COOKING PROCESS, SELECT AN ACTION WITH WHICH TO CONTINUE (screen D)	

4.2.9 Favourites

The Favourites function allow creation of a list of programs that you used most often or like the most to use. Then you have quick access to these saved programs without having to search for them among the program groups.

 The procedure for saving programs to Favourites is described in chapter 4.2.3/step 4.3.

1 PRESS



1.1 OPTION: STARTING A PROGRAM

 Tapping one of the stored programs brings up screen C, allowing cooking to be started immediately, or program editing as in chapter 4.2.3.

1.2 REMOVING A PROGRAM FROM FAVOURITES

 Tap the program you wish to remove and hold longer than 2 seconds
Press

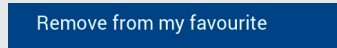

4.2.10 Automatic program start

Whenever working in manual mode, during work with programs in EasyCooking mode, or in Extras mode displaying screen B, C or D, or in the cooking progress screen, the program can be set to start automatically under your set conditions.

4.2.10.1 Setting a program for automatic start-up

1 AT THE TOP OF THE SCREEN, PRESS
Applies to screens B, C, D and the cooking progress screen



2 PRESS

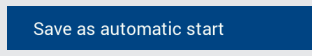

3 SELECTING OR SETTING THE AUTOMATIC START OPTION, AS NEEDED



4 PRESS



The automatic start program set is indicated by a symbol on the upper ribbon of main screen A.



Before automatic program start-up, the set date and time appear on the screen with the count, and an audible signal sounds

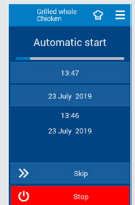

You can skip the count by pressing

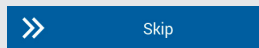

You can also cancel automatic start by pressing



4.2.10.2 Viewing, editing or deleting an automatically started program

1 ON THE MAIN SCREEN, PRESS
The list of programs set for automatic start-up displays.



1.1	<p>OPTION: VIEWING AUTOMATIC START ITEMS Tap the desired program</p>	
	<p>After viewing, press</p>	
1.2	<p>OPTION: EDITING AUTOMATIC START ITEMS</p>	
	<p>After making changes, press</p>	
1.3	<p>DELETING AN AUTOMATICALLY STARTED PROGRAM At the program that you wish to delete, press</p>	
	<p>Select</p>	
	<p>Confirm deletion The program is removed from the list of automatically started programs</p>	

4.2.11 Calendar

Allows creating, viewing and editing of planned events.

1	<p>PRESS</p>	
2	<p>PRESS</p>	
	<p>Depending on which calendar display option you used last, either an overview of the current month or a list of all planned events appears. To toggle between the calendar display modes, press</p>	
	<p>Select the desired display Month - the month view displays. To choose another month use the arrows or .</p>	
	<p>Plan - The list of all events displays, including programs set for automatic start-up</p>	
2.1	<p>OPTION: CREATING A NEW REMINDER In calendar view mode, tap the desired day. If you want to choose a different month from the current one, use the arrow or .</p>	
	<p>Press</p>	
	<p>Edit the date, starting time, repetition interval and any text reminders</p>	
	<p>Save settings</p>	

The reminder will display as one full white square near the selected date, even if you enter more than one reminder for one day.

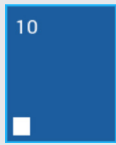

- 2.2 OPTION: VIEW REMINDERS**
 Select the calendar viewing mode (Month or Plan)
 - In the calendar view, choose the desired day.
 - In list mode, select the desired day and event

Tap the desired event and view the reminder items

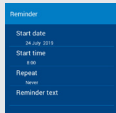

Press



- 2.3 OPTION: ADJUSTING REMINDER/TIME**
 In the list of saved reminders or in the calendar, tap the desired reminder

Edit the desired reminder item

Press

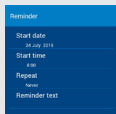

- 2.4 OPTION: DELETING REMINDERS**
 In the list of saved reminders or in the calendar, tap the desired reminder

Press

Select

Press

The event is deleted

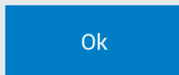
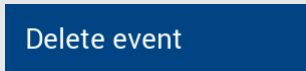
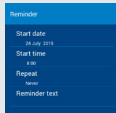

4.2.12 Chef tips or program information

For most pre-set programs, brief chef tips and advice on the program are available. These tips can be viewed or edited as needed and be added to programs you have created.

4.2.12.1 View chef tips

- 1 IN THE SCREEN WITH THE PROGRAM PREVIEW (SCREEN C), PRESS**



- 2 READ THE INFORMATION AND RETURN TO THE PROGRAM PREVIEW**



4.2.12.2 Edit chef tips

- 1 SELECT THE PROGRAM YOU WISH TO EDIT THE CHEF TIPS FOR AND HOLD IT FOR LONGER THAN 2 SECONDS**

- 2 FROM THE MENU, CHOOSE**



- 3 PRESS**

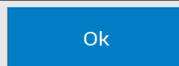

- 4 PRESS**



5 ENTER INFORMATION OR PROGRAM TIPS



6 PRESS



4.2.12.3 Creating chef tips for a new program

To create tips for a new program, see  4.2.2/ step 7.5

4.3 EASY COOKING







Cooking in the Easy Cooking mode enables even a less experienced chef to achieve excellent results. It is not necessary to know the individual phases of the cooking process in detail and laboriously set the individual steps. The Easy Cooking system is a type of guide that will automatically recommend and set the suitable technology based on the type of meal and the desired result.

In the Easy Cooking mode the user limits themselves to simply selecting a meal, possibly adjusting the doneness level and surface colour and then presses the Start button. The combi oven does everything else for you.

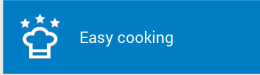
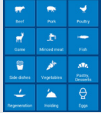
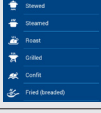
You may enter the cooking process at any phase and edit the pre-set parameters so that the result meets your expectations.

If you are satisfied with the final product, you can save the selected technology to your programs and use it at any time to achieve the same quality results.

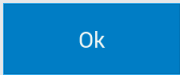
4.3.1 Cooking with Easy cooking

1 ENTER THE EASY COOKING MODE	
2 SELECT A MEAL CATEGORY	
3 SELECT MEAL SPECIFICATIONS	
4 SELECT MEAL SIZE	
4.1 OPTION: EDIT TEMPERATURE  Use the temperature slider as necessary to set the surface doneness of the meal (or the core doneness).	
5 PRESS	
6 PROGRAM PREVIEW APPEARS (screen C) All program steps display on a single screen with the option to edit or add further steps.	
6.1 OPTION: EDIT PARAMETERS  After clicking on the selected program step, you can change parameters exactly as when working with programs (screens B, C), as needed.	
7 PRESS	

4.4 MULTITASKING

The Retigo Blue Vision combi oven enables you to work on multiple levels at once, without having to interrupt a cooking process that is running. For example, you may be cooking and at the same time, use Multitasking to switch to the programs section and prepare a new program. Multitasking does not enable performing such operations that would affect or interrupt the actual cooking process, e.g. start automatic cleaning.

4.4.1 Using the Multitasking function

1 START COOKING IN ANY WAY, SUCH AS USING THE PROGRAMS

 4/4.2.1



2 PRESS THE BUTTON



3 PRESS THE BUTTON

You will go to the main screen (A)



4 AFTER SWITCHING, A CHEF'S HAT ICON ON A GREEN BACKGROUND WILL START FLASHING AT THE TOP OF THE DISPLAY

The icon indicates that a cooking process is running

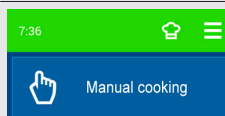

5 ON THE MAIN SCREEN (A), YOU MAY SELECT AN OPTION WITH WHICH YOU WISH TO WORK

This selection must not affect the cooking process. You cannot select, for example, the Cleaning function

6 RETURN TO THE COOKING PROCESS SCREEN BY PRESSING THE FLASHING CHEF'S HAT ICON.













05 | EXTRAS

The EXTRAS functional group (button A10) contains special cooking programs for modern culinary methods, which allows you to use the combi oven for unusual procedures.

5.1 LOW-TEMPERATURE COOKING

This mode is especially appropriate for slow, gentle cooking of various meats. It allows maximum nutritional values to be retained in meat. The meat loses a minimum of weight and is juicy inside.

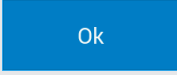
5.1.1 Cooking in Low-Temperature Cooking mode

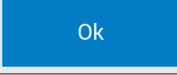









1	ENTER EXTRAS	
2	PRESS	
3	SELECT A COOKING MODE	
3.1	OPTION: COOKING ACCORDING TO TIME	
	Select the food type	
	As necessary, use the scroll bar to change the time required for preparing the food.	
	<i>The temperature of the selected food type is a fixed pre-set and cannot be changed.</i>	
	Press	
	Shows a preview of all program steps (QuickView, screen C). By clicking on the selected program step, you can change parameters exactly as when working with programs (screens B, C), as needed.	
	Start the cooking process by pressing	
3.2	OPTION: COOKING BY PROBE TEMPERATURE	
	Press	
	Select the food type	
	Use the scroll bar to set the desired time temperature at the centre of the food	
	Press	
	Shows a preview of all program steps (QuickView, screen C). By clicking on the selected program step, you can change parameters exactly as when working with programs (screens B, C), as needed.	
	Start the cooking process by pressing	
	<i>If there is no probe in the food, the following message appears: Insert the probe. After inserting the probe, press</i>	
		
4	AT THE END OF THE PROCESS, SELECT THE TASK YOU WANT TO CONTINUE (screen D)	



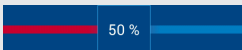



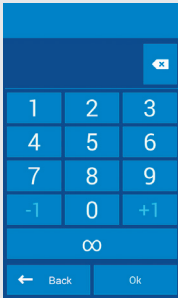
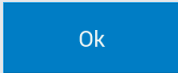

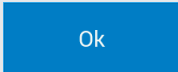

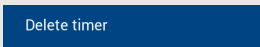

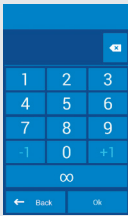
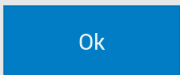
5.2 RACK TIMING

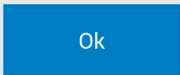
For individual drawers that you prepare in the same cooking mode (steam, hot air or combination), the rack timing function allows you to assign different processing times or different final temperatures for the centre of the food.

With rack timing, it is also possible to create timing programs (□ 4.2/4.2.7), which you may save to the program directory and call up at any time without any further settings. You merely define the specific times for the individual racks.

5.2.1 Cooking in Rack Timing mode – Manual settings

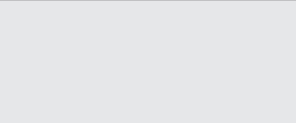
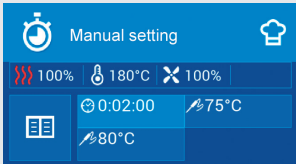
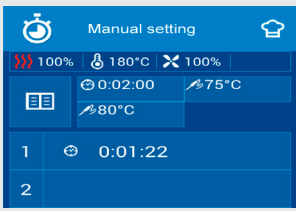
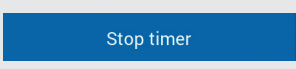
1	ENTER EXTRAS	
2	PRESS	
3	SELECT MANUAL SETTINGS	
4	SELECT A COOKING MODE	
5	BASED ON THE SELECTED COOKING MODE, SELECT:	
5.1	Humidity level (□ 4/4.1, point B2) for combi mode	
5.2	Flap valve opening level (□ 4/4.1, point B3) in the case of the Hot air mode	
6	SELECT A DEFAULT TEMPERATURE FOR THE COOKING CHAMBER	
7	SELECT A DEFAULT SETTING FOR THE FAN (□ 4/4.1, point B6)	
8	PRESS	
9	SET THE TIME OR CORE PROBE TEMPERATURE	
9.1	OPTION: TIME SETTING Set the time in the clock order: Minutes: Seconds after which the timer stops	
	Press	
	Enter the name of the timer	
	Press	
9.1.1	OPTION: ADDING ANOTHER TIMER To add another timer, repeat the procedure from point 8-9	

9.1.2	<p>OPTION: DELETING A TIMER For the timer that you wish to delete, press</p>	
	Select option	
9.2	<p>OPTION: CORE PROBE TEMPERATURE SETTING Press</p>	
	Set the core probe temperature to stop the timer	
	Press	
	Enter the name of the timer	
	Press	
9.2.1	<p>OPTION: ADDING ANOTHER TEMPERATURE To add another temperature, repeat point 9.2</p>	
	<p><i>The combi oven is equipped at the factory with just one temperature probe. In that case, you must first pierce the probe into the food that will probably reach the target temperature earlier. Then you have to stab the probe into the other food whose preparation will take longer. For this purpose, it is better to equip the combi oven with a second temperature probe (optional accessory at additional cost). If two probes are used, cooking can be done with both of them, and a different final temperature can be set for each.</i></p>	
9.2.2	<p>OPTION: COOKING BY PROBE TEMPERATURE For a temperature you want to delete, press</p>	
	Select option	
10	START THE COOKING PROCESS BY PRESSING	
11	<p>AFTER PREHEATING, THE CONTROL SCREEN APPEARS FOR THE SET RACK TIMING In our example, 6 empty drawers are shown, one timer, and two core probe temperatures. The number of drawers can be set based on the size of the machine in User settings ( 6/6.1)</p>	
12	<p>INDICATE THE TIMER YOU WANT TO PLACE IN WHICH DRAWER BY PRESSING The selected timer is highlighted.</p>	
13	<p>TAP IN ONE OR MORE DRAWERS THAT YOU WANT TO USE A TIMER FOR The timer assigns to the selected drawer and starts automatically. As soon as the drawer with the timer is finished, it starts to flash and an acoustic signal sounds. Use the same procedure for the other set timers.</p>	
13.1	<p>Tap the drawer with the timer you want to stop. Press</p>	
13.2	<p>OPTION: ENDING BEFORE TIME HAS ELAPSED / TEMPERATURE HAS BEEN REACHED You can stop the running timers and thus the whole cooking process by pressing</p>	

5.2.2 Cooking in Rack Timing – according to preparation type

1 ENTER EXTRAS



2 PRESS



3 SELECT FOOD MODIFICATION

 *Basic parameters, like mode, humidity, temperature, space and fan settings are already pre-set, but they can be easily changed.*

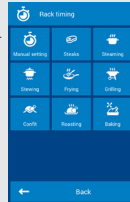

4 PRESS

Set the timer or core probe temperature according to the procedure in the chapter, steps 9 to 13.2.



5.3 EXTRAS (FURTHER FUNCTIONS)

The EXTRAS functional group still contains these special programs:

Sous-vide

Modern cooking technology in which the food is inserted into a vacuum sous-vide bag.

Confit

The program is pre-set for preparing food – especially meats – through long cooking in fat at a relatively low temperature (110°C).

Smoking

This special preparation requires the additional Vision Smoker. Using this adds a smoky flavour according to the type of wood chips burned.

Sterilization

This function is for canning meat, vegetables, fruit, prepared foods, jams, marmalades and mushrooms. It requires that the food be put into the combi oven in appropriate containers (glass jars, tins) sealed in the manner recommended for canning.

Drying

Program appropriate for traditional drying of fruit, vegetables and meat.







Regeneration and Holding

This program is used for warming cooled foods. Maintenance then keeps the food at the set temperature for the necessary length of time. Food can be warmed and maintained either in cooking containers or right on plates.

Golden touch

Controlled food completion through high-temperature baking for outstanding colour and crispness.

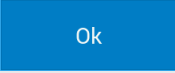
5.3 Using the other EXTRAS functions

1 ENTER EXTRAS	
2 SELECT THE DESIRED FUNCTION	
3 SELECT A MEAL CATEGORY	
3.1  OPTION: ADJUSTING TEMPERATURE/TIME As necessary, use the scroll bar to adjust the preparation temperature or time.	
4 PRESS	
5 PROGRAM PREVIEW APPEARS (QUICKVIEW) All program steps display on a single screen with the option to edit or add further steps.	
5.1  OPTION: EDITING PARAMETERS After clicking on the selected program step, you can change parameters exactly as when working with programs (screens B, C), as needed.	
6 PRESS	

06 | HELP

Part of the main screen A is the Help function in the form of important contacts and a simplified operating manual for the combi oven. You can use the contacts at times when you're not sure of the procedure or need detailed advice from an experienced person. The simplified manual will help you in situations when you need to refresh knowledge of a work procedure or combi oven setting as fast as possible.

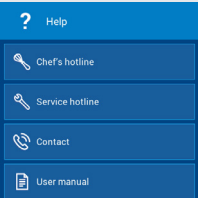
1 ON THE MAIN SCREEN, PRESS	
2 SELECT THE DESIRED HELP ITEM <ul style="list-style-type: none">- Chef's hotline: Contains telephone contacts to experienced chefs- Service hotline: Contains contacts to people who will advise you on settings the combi oven or at times when something isn't working the way it should.- Contact: Contains complete contact information on the combi oven manufacturer.- User manual: Contains a simplified description of all basic functions of the combi oven and the working methods.	

07 | SETTINGS

7.1 BASIC SETTINGS

1. USER SETTINGS

 When pressed, the numerical keypad will appear. To enter the settings, enter the password **1001** and confirm using OK.

Date and time

Set or adjust the time. Only an authorized service has the authorization to adjust the date.

Language

For setting the language system.

Temperature units

Allows setting temperature units as °C or °F.

Sounds

Set the melody, volume and sound duration for the following items:

- Errors
- Keyboard
- Ending the cooking process
- Audible step signal
- Preheating
- Rack timing
- Planned events
- End of cleaning
- Core probe

Display

Enables the setting of:

- Screen brightness - set using a slider. The default setting is 100%.
- Screensaver - Select the screensaver and the time after which the combi oven will switch to the screensaver mode when idle. A further option is to show the time and a slide show (screen saver made up of images).
- Colour schemes — Offers a choice of system colours throughout the menu. The options are blue, black, red and green. The default setting is blue.

Cooking

Enables various preferences to be set for comfortable operation of the machine:

- **ACM** (Automatic capacity management) - this function will ensure that the combi oven will identify the amount of food that is inserted and will extend the cooking time accordingly to achieve the required temperature in the cooking chamber.
The default setting is "On"

- **Preheating**

- Preheat always active (for Manual mode settings). The default setting is "ON" .

- Increasing the temperature allows setting how many degrees higher than the set temperature the cooking chamber should preheat to. The default setting is 15°C. Example: If the set temperature is 150°, the combi oven automatically heats to 165°C. ATTENTION: Applies only to HOT AIR and Combo mode. In Steaming mode, the preheat temperature equals the set temperature.

- Maximum preheating time — For setting the maximum time after which the cooking process starts and begins to count down the time. The default value is 5 minutes.

- **List of modes**

Allows you to set which cooking modes will be available in the mode ribbon, in Manual mode or during program creation. Pressing the symbol  allows more modes to be added.

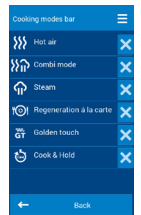

- **Default values**

Allows editing the basic parameters, such as humidity, core temperature probe, chamber temperature, fan speed and the following functions

- Hot air
- Combined mode
- Steam
- Warming on the plate
- Golden touch
- Cook&Hold

- **Standby after cooking**

Allow

The default setting is off

Shut-off after

The default setting is 1 min.

- **Time units**

For selecting the time format: h:m or h:m:s

- **Extra time**

Allows setting whether the offer "Continue cooking" is shown on the screen after cooking is over.

The default setting is "On" .

- **Learn function**

Allows setting whether the offer "Load as a program" is shown on the screen after cooking is over.

The default setting is "off" .

- **Eco Logic**

Allows setting whether the offer "Eco Logic" is shown on the screen after cooking is over.

The default setting is "On" .

Rack timing

- Number of racks – here you can select the number of racks shown on the rack timing program control screen (☰ 5/5.1). **The maximum number is 10 racks.**
- Number of positions per rack – each rack can also be divided into positions. Max. number per one rack is 2 positions.
- Show similar programs – During cooking in Rack Timing mode, the combi oven automatically offers other similar programs that can be prepared at the same time. The default setting is "On" .
- Mode ribbon – Allows you to set which cooking modes will be available in the mode ribbon during Rack Timing. Pressing the symbol ☰ allows more modes to be added.
- Pre-set values – For drawers, allows editing the basic parameters, such as humidity, core temperature probe, chamber temperature, fan speed and the following functions
 - Hot air
 - Combined mode
 - Steam
 - Warming on the plate

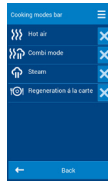

Cleaning

• **Cleaning programs**

This function is not accessible for ordinary users – only for service technicians.

• **Standby after cleaning**

Allows the combi oven to turn off after cleaning is done. The combi oven's shut-off time can be set in minutes.

The default is "Allow"

Turn off after: the default value is "1 min."

Locks

Allows programs to be locked against alteration.

After locking, the program can be launched, but it can't be edited or deleted.

• Program sets

The default setting is "Off" .

Setting the "Off" option allows changes to be made in a saved program, except for making changes for one specifically started program using QuickView.

• Appliance lock

This function is not accessible for ordinary users – only for service technicians.

• Lock for running program

The default setting is "Off" .

After activation, it will not be possible to make any changes to the saved program even after it has started. In the QuickView program steps view, it will not be possible to edit the steps.

• Profile lock

The default setting is "Off" .

After activation, it will not be possible to make any changes to a profile.

• Calendar lock

The default setting is "Off" .

After activation, it will not be possible to change any of the planned events or automatic starts.

2. CALENDAR

Allows creating, viewing and editing of planned events. There is a detailed description in chapter 4.2.11.

3. INFO

When pressed, combi oven and control system details will be shown.

4. SERVICE

This option is permitted only to service technicians or experts and is protected by a password.

5. OPERATION LOGS

Errors

This function is not accessible for ordinary users – only for service technicians.

Log

Shows a complete report of all operating events.

HACCP record

For displaying a complete report of HACCP data right on the display.

6. USB DRIVE

Back up various items of the control system to an external USB drive or conversely import items from an external disk to the combi oven.

• **From the appliance to a USB drive**

- Programs – A detailed description of saving programs is given in the separate chapter 7.1.1.
- Errors – the filename has the format "ErrorReport_Blue Vision_0-rrrr_mm_dd.txt"
- HACCP- the filename has the format "HaccpReport_Blue Vision_0-rrrr_mm_dd.haccp"
- Log list - the filename has the format "Log_Blue Vision_0-rrrr_mm_dd.txt"
- Settings - the filename has the format "Oven_Blue Vision_0.zip"
- More – This offering is not accessible to ordinary users – only for service technicians with a special password.

When one of the options is selected, the message **Connect a USB drive** will appear and the system will wait for its connection (☰ 1.2, point 6).

After connection, the message **USB drive connected** and the offer **Copy data to USB drive** will appear. Tap the menu to transfer the data to the USB drive.

• **From USB to the appliance**

- Programs – A detailed description of program copying is given in the separate chapter 7.1.2.
- Melody - Only files in the "*.wav" format
- More – This offering is not accessible to ordinary users – only for service technicians with a special password.













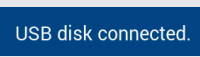

When one of the options is selected, the message **Connect a USB drive** will appear and the system will wait for its connection (☰ 1.2, point 6).

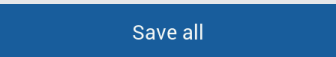
After connection, the equipment USB will appear, which can be browsed through in the same way as a regular PC. You can select and copy individual files or even whole folders. Tapping on the selected file or folder will copy it to the combi oven.

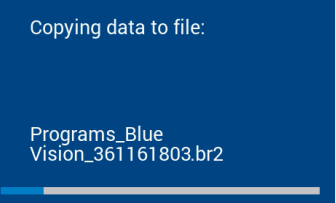
 **Program files (*.br2), HACCP (*.haccp) may only be administered using VisionCombi software, which is available at the manufacturer's website.**

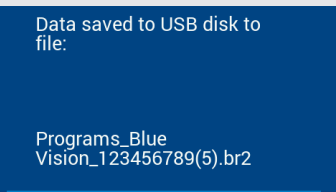
7.1.1 Saving programs to the USB drive

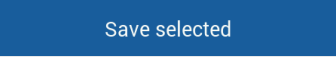
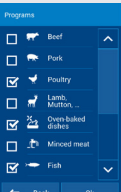
If you want to save combi oven items to an external USB drive, do the following:

<p>1 PRESS</p>	
<p>2 PRESS</p>	
<p>3 PRESS</p>	
<p>4 A MESSAGE APPEARS Connect a USB drive (see 1.2, point 6)</p>	
<p>5 A MESSAGE APPEARS  If the USB drive is damaged or incompatible, "USB drive was not recognized" will appear. Use a different USB drive.</p>	
<p>5.1 OPTION: SAVE ALL For saving all programs from the combi oven memory into one file on the USB drive.</p>	
<p> Press</p>	
<p>The default output file is displayed. You can overwrite the file name as you need to.</p>	
<p>Confirm the pre-set or your own entered file name by pressing</p>	
<p>Saving progress is displayed.</p>	
<p> An information message appears when saving is successful. If saving does not succeed, "Error when saving data" appears. Repeat the saving procedure using a different USB drive.</p>	
<p>Disconnect the USB drive and press</p>	
<p>5.2 OPTION: SAVE SOME Allows selecting and saving selected programs or folders</p>	
<p> Press</p>	
<p>All programs with tick boxes are displayed</p>	
<p>5.2.1 OPTION: SAVING COMPLETE INGREDIENTS Tapping on any tick box selects a complete folder, including the program inside</p>	

5.2.2 OPTION: SAVING SPECIFIC PROGRAMS

Tapping on the file name shows a menu of all programs, along with tick boxes.



Tapping on any tick box selects the desired programs



After selecting ingredients or programs, press

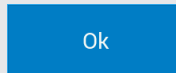

The default output file is displayed. You can overwrite the file name as you need to.

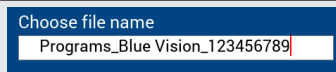

Confirm the pre-set or your own entered file name by pressing

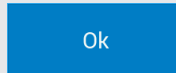

Saving progress is displayed.

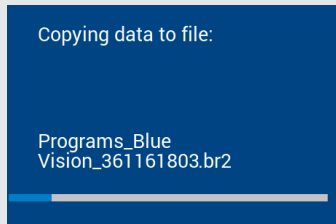

An information message appears when saving is successful. If export does not succeed, "Error when saving data" appears. Repeat the saving procedure using a different USB drive.

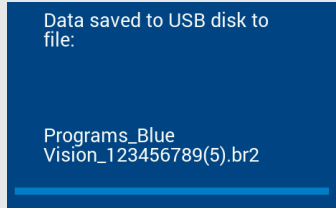











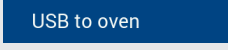



Disconnect the USB drive and press

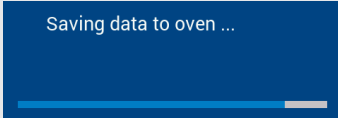
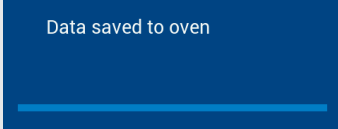

7.1.2 Copying files from a USB drive to the appliance

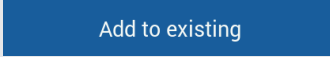
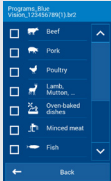
If you want to copy programs from an external USB drive into the combi oven's memory, do as follows:

1	PRESS	
2	PRESS	
3	PRESS	
4	SELECT	
5	A MESSAGE APPEARS Connect a USB drive (see 1.2, point 6)	
6	CONTENT OF USB DRIVE DISPLAYS  <i>Displays only files with the suffix "br2". This format must only be administered using VisionCombi software, which is available at the manufacturer's website.</i>	
6.1	OPTION: OVERWRITE ALL For replacing all programs in the combi oven memory with programs on the USB drive	
	 Press	
	 CAUTION – All original programs in the combi oven memory will be irrecoverably overwritten with programs from your USB drive	
	Saving progress is displayed.	
	An information message appears when saving is successful.	
	Disconnect the USB drive and press	
6.2	OPTION: ADD TO PROGRAMS For adding new programs from a USB drive to the combi oven memory	
	 Press	
	A menu of folders with programs, along with tick boxes	
6.2.1	OPTION: ADDING COMPLETE INGREDIENTS Tapping on any tick box selects a complete folder, including the program inside	

6.2.2 OPTION: ADDING SPECIFIC PROGRAMS

Tapping on the file name shows a menu of all programs, along with tick boxes.

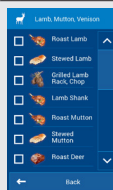

Tapping on any tick box selects the desired programs



If you want to select programs from other folders, go back to a higher level using the "Back" button and select a different folder. Programs already ticked will stay ticked.

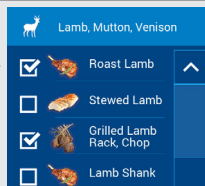

After selecting ingredients or programs, press

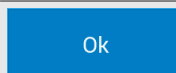

Saving progress is displayed.

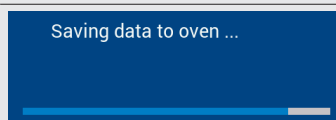

An information message appears when saving is successful.

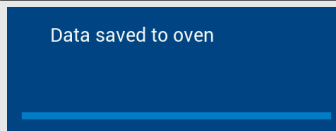

Disconnect the USB drive and press

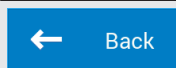

7.2 PROFILES

Retigo Blue Vision combi ovens offer a unique option to adapt the main screen (A). Based on your own needs, on the main screen you may, for example, change the button size, their arrangement, remove or add buttons, change their colour, change the background colour, etc. You can save the change as your custom PROFILE. The number of added buttons is unlimited. If the buttons are outside the screen area, use the scroll bar on the right side of the display.

7.2.1 Selecting a saved profile

1 PRESS BUTTON A9



2 PRESS



3 SELECT THE DESIRED PROFILE

Pressing the profile will activate it and the main screen will change.

*The profile set by the manufacturer is stored under the name of **Default**.*

7.2.2 Creating/editing your custom profile

1 PRESS BUTTON A9



2 PRESS



3 EDIT THE APPEARANCE AND LOCATION OF THE BUTTONS.

At each button of the current profile there will be a button



3.1 OPTION: EDIT BUTTON SIZE (SMALL/MEDIUM/LARGE)

3.2 OPTION: EDIT BUTTON COLOUR (12 COLOURS)

3.3 OPTION: DELETE THE BUTTON FROM THE MAIN SCREEN

3.4 OPTION: CHANGE BUTTON LOCATION
Press and hold down any button to change its position on the screen. In this way, a button can be moved to any location on the screen.

4 EDIT THE NUMBER AND TYPE OF BUTTONS OR THE SCREEN BACKGROUND

The button is located in the bottom right corner of the screen.



4.1 OPTION: ADD BUTTON
A list of buttons will appear. Tick the button that you wish to add to your profile. To confirm your selection, press

4.2 OPTION: DELETE ALL BUTTONS
When pressed, you will be prompted, "Are you sure?" Pressing **Yes** will delete all buttons.

4.3 OPTION: CHANGE BACKGROUND
The system will offer 11 colour main page backgrounds.

5 PRESS

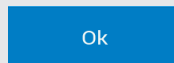

5.1 OPTION: SAVE AS A NEW PROFILE
If you have made changes to the default profile, they can be saved only as a new profile. The default profile itself cannot be changed. Enter the name of the profile and confirm.

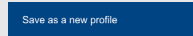

In this way, your personal profile was created.

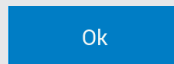

5.2 OPTION: SAVE PROFILE
Your personal profile will be saved under the same name with the changes.



If you want to change the home or personal profile(s), set their locks according to chapter 7.1 BASIC SETTINGS / 1st USER SETTING/Locks

08 | MAINTENANCE

GENERAL INSTRUCTIONS

For the entire period of operation, the appliance must undergo regular inspections, tests and updates for operating this type of appliance in accordance with applicable regulations in the country of use.

The appliance must be kept clean, and any remains of old fat and food must be removed. Only regular maintenance and adherence to all instructions can ensure that the appliance will last a long time, operate well, and prepare high-quality foods.

Once work is over, close the appliance’s water feed! Leave it open only if it is connected to a water treatment device requiring regular regeneration. When the supply is closed, regeneration would not take place, and the water treatment device would not work properly.

The warranty does not apply to damage caused by failure to follow these instructions or caused by inadequate cleaning!

To clean the appliance, the following are not to be used:

- a high-pressure cleaning device
- coarse or sand-based cleaning agents
- objects for mechanical surface cleaning (wire brushes, scrapers, knives)

The warranty does not cover damage arising caused by detergents other than those recommended by the manufacturer, or by use of detergents recommended by the manufacturer in contradiction to the manufacturer’s recommendations!

If the appliance is defective or does not behave normally, stop using it, unplug it, and contact an authorized service company.



Before using or maintaining the appliance, become thoroughly familiar with all instructions, prohibitions and recommendations in the chapter on safety INSTRUCTIONS (see “Basic information”, chapter 2 “Safety instructions”).

Do not spray water on the door glass and lights if the internal temperature is above 65°C – this may break the glass!

MAINTENANCE OVERVIEW		
INTERVAL	DESCRIPTION	DESCRIPTION OF TASK
Daily	Cooking chamber	Cleaning with the automatic program and Active Cleaner
	Door seal	Manual cleaning using a cloth, detergent and water
	Exterior	Manual cleaning using a soft rag and substance for treating stainless steel and glass
Weekly	Cooking chamber	Cleaning with the automatic program and Vision Descaler
	Space behind the inner wall	Hand cleaning using Manual Cleaner or Puron K and the following RINSE program
	Air filter	Manual cleaning with detergent or in a dishwasher
	Cleaning the door and glass	Hand cleaning using cloths and appropriate cleaning agents
Every six months*	Boiler	Descaling with the automatic program and Strip-A-Way descaler
Yearly	Entire appliance	Inspection by an authorized company

* applies only to appliances with a boiler

8.1 DAILY MAINTENANCE

The appliance must be cleaned daily with the manufacturer’s recommended cleaning agents. If not cleaned adequately, the appliance or its parts may become damaged.

CLEANING THE COOKING CHAMBER

For everyday appliance cleaning, use one of the programs in the Cleaning function, which you will find in the appliance’s menu.

The manual for using automatic cleaning can be found in chapter

9. Automatic cleaning.



When cleaning, use only cleaning agents recommended by the manufacturer – especially Active Cleaner and Vision Descaler.

After the cleaning program is done, check whether cleaning was adequate. If not, repeat the cleaning. If residue of a cleaning agent sticks to the surface of the cooking chamber or its accessories, rinse it with a hand shower or start the Rinse with water program. If this isn't done, the stainless-steel surface of the cooking chamber can distort and discolour when the appliance is used at high temperatures. The warranty does not cover damage caused in this way!

After the cooking chamber has been cleaned, open the door and leave it half open to fully dry out the chamber.



When working with detergents always take great care to follow the manual and recommendations of the detergent manufacturer. This will prevent a health risk!

When cleaning the appliance, always use safety gear and prescribed work clothing (gloves, goggles, mask)!

When using automatic cleaning programs on appliances with a loading trolley, it is absolutely necessary to move the trolley into the appliance before starting the cleaning program!

Automatic cleaning programs are not for cleaning cooking containers or sheets!

When the appliance is being cleaned with a detergent, its temperature must never exceed 70°C. At higher temperatures, the detergent may bake onto the surface of the cooking chamber and form stains resembling rust or do other damage to the appliance. The warranty does not apply to this type of damage!

CLEANING THE DOOR SEAL

After the cooking chamber has been cleaned, wipe around the door seal with a soft cloth soaked in detergent. Then wipe around the seal with a cloth soaked in clean water, and then dry it with a dry cloth. After cleaning is over, leave the appliance's door half open, so that the cooking chamber and door seal can properly dry off.



CLEANING THE EXTERNAL PARTS

Clean the outside of the appliance with a soft cloth and a detergent intended for cleaning and treating stainless steel and glass.

8.2 WEEKLY MAINTENANCE

DESCALING THE COOKING CHAMBER

If a crust of limescale appears on the surface areas of the cooking chamber, descale the cooking chamber with the "Cooking chamber descaling" program, and use the Vision Descaler product for this.



If the cooking chamber becomes considerably scaled, find out the current composition of the water, the correct operation of the water treatment device, if there is such an appliance on the front end. Damage caused by water that does not meet the manufacturer's requirements, or inadequate maintenance, is not covered by the warranty!

INSPECTING AND CLEANING THE SPACE BEHIND THE INNER WALL

For weekly maintenance, proceed as with daily maintenance (see chapter 7.1) and thoroughly check the space behind the inner wall.

1. Clean out the left and right racks (does not apply to appliances with a loading system).

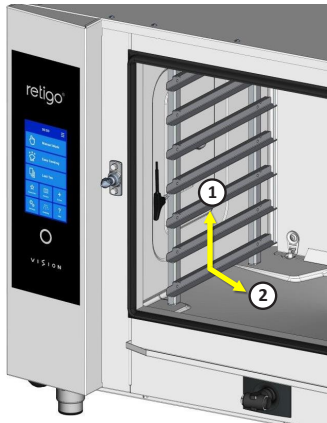

2. Release the locks fastening the wall in front of the fan. A screwdriver or coin can be used to release them.

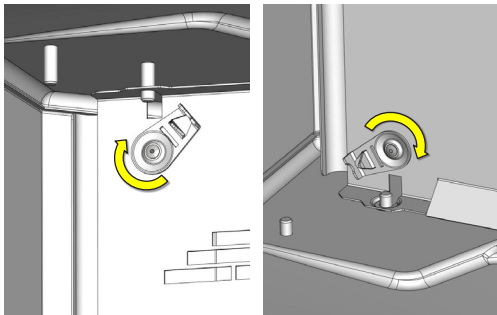

Open the inner wall by pulling on the left side.

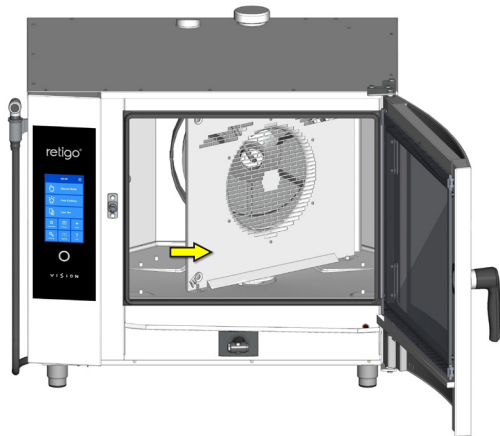

If parts of the space are soiled or calcified, close the inner wall, secure it with the lock, and choose the right cleaning program for the type and level of soiling. After the cleaning program is done, check whether cleaning was adequate (proceed according to points 2 to 3). If everything is not clean enough, repeat the process. If cleaning was adequate, close the inner wall (in front of the fan), use the integrated lock to secure it against opening by itself, and put both racks back (does not apply to appliances with a loading system).

3. After cleaning is over, leave the appliance doors open so that the cooking chamber can fully dry out. This also makes the door seals last longer.

HAND CLEANING OF THE SPACE BEHIND THE INNER WALL



In rare cases, even repeated automatic cleaning and descaling may be ineffective against tough grime behind the inner wall. In such cases, a cleaning agent (Manual Cleaner) or descaler (Puron K) must be applied by hand as follows:

1. Open the inner wall in the manner described earlier in this chapter.
2. Spray Manual Cleaner or Puron K (for descaling) onto the entire surface of the inside wall — fan, water sprayer (tube in the middle of the fan into which the injection leads) and the heating element — and let it work for 15 minutes.
3. Thoroughly rinse the cooking chamber by starting the automatic cleaning program Rinse with water.
4. After the cleaning program is done, check whether cleaning was adequate. If everything is not clean enough, repeat the process. If cleaning was adequate, close the inner wall (in front of the fan), use the integrated lock to secure it against opening by itself, and put both racks back (does not apply to appliances with a loading system).
5. After cleaning is over, leave the appliance doors open so that the cooking chamber can fully dry out. This also makes the door seals last longer.

CLEANING THE AIR FILTER

Once a month, check and clean the air filter, which is on the bottom left side of the appliance.

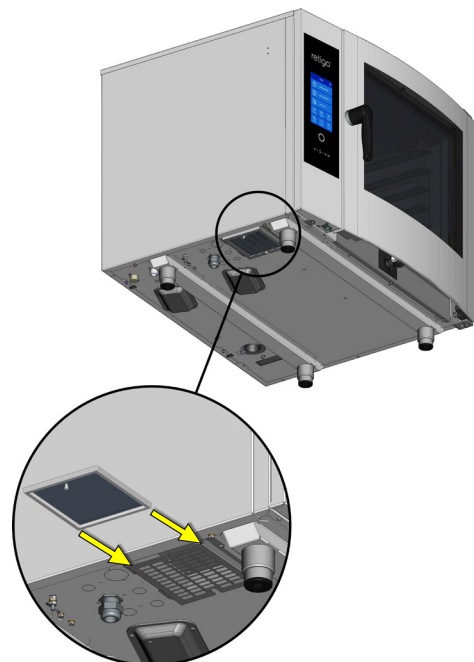

Remove the filter toward the closer side of the appliance and thoroughly clean it with detergent or in a dishwasher. After cleaning, let it thoroughly dry.



If the air filter gets clogged, the appliance's electronic components may overheat and the appliance's function may be limited.

CLEANING THE DOOR, GLASS AND DRIP TRAY

1. Open the appliance door.
2. Check the drip tray at the bottom of the door. If it is dirty, clean it with a soft cloth and detergent.
3. Check the drip tray at the bottom of the appliance. If it is dirty, clean it with a soft cloth and detergent.

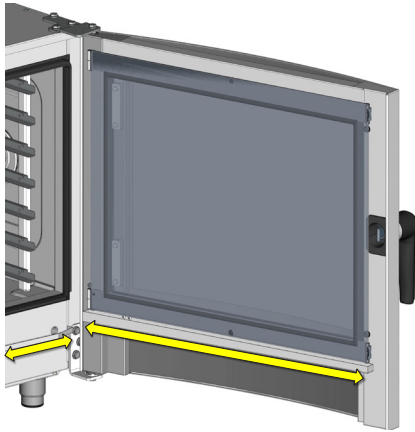

Unlock the internal glass and tilt the glass up.



5. Clean all glass surfaces with a clean rag and detergent intended for glass.
6. Then dry the glass surfaces with a dry cloth.

7. Wipe the seal of the middle glass with a damp cloth and then dry it.

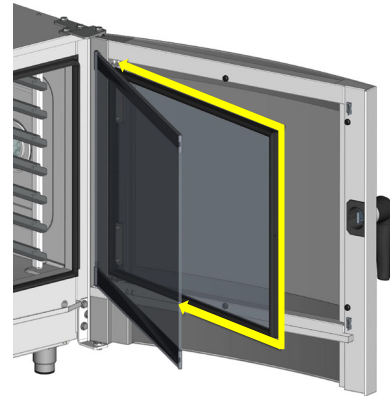

8. Gradually return the middle and inner glass to their original position and secure them with the lock by gently pressing the inner glass near the lock.

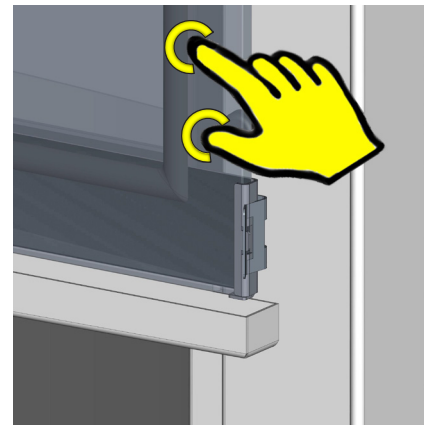

8.3 SIX-MONTH MAINTENANCE

DESCALING THE BOILER

Even though appliances with a boiler are equipped with an automatic function that ensures regular exchange of water in the boiler and cleans the boiler of ordinary deposits and dirt, it must be thoroughly descaled once every 6 months. This prevents damage to the heating elements and ensures that the boiler works properly. The warranty does not cover damage due to a scaled boiler!

Depending on the water quality, the appliance's boiler may need descaling more often. If the boiler is heavily scaled, the appliance may not work properly.



Only an authorized service company is to descale the boiler.

8.4 MANUAL MAINTENANCE

For safe, trouble-free operation, and to prolong its service life, the appliance and accessories must be inspected at least once a year by an authorized service company.

09 | AUTOMATIC CLEANING

The Blue Vision combi oven is equipped with an automatic cleaning system, which ensures that the combi oven will always be perfectly hygienically clean.

Regular use of this automatic cleaning system saves you time and significantly prolongs the life of the appliance.

Thanks to this system, the only cleaning tasks on this appliance are:

- choosing the right cleaning program for the level of soiling
- starting the cleaning program and adding detergent.

9.1 AUTOMATIC CLEANING: WHAT YOU SHOULD KNOW



For automatic cleaning, you must use the Active Cleaner detergent, which is packed in 60 g plastic bags. It is delivered in small buckets containing 50 packs.

The detergent's package protects it from moisture damage, but it should nonetheless be stored in places where no water or excess humidity is present. Always use the detergent immediately after opening the package. Never leave it open, and most importantly, do not leave it in damp places or unsupervised.



Important:

- If a detergent other than the original Retigo Active Cleaner is used (or Manual Cleaner, Vision Descaler), Retigo takes no responsibility for any damage, and the warranty does not apply to damage caused in this way.
- Keep the detergent out of the reach of children.
- When handling the detergent, follow all rules for working safely with chemical substances, and especially use safety gear (mainly gloves and protective glasses).
- Follow the instructions on the detergent package.
- The detergent must never come into direct contact with the skin, eyes or mouth.
- Never open the appliance's door when the cleaning program is running – this can cause a chemical exposure hazard.
- Before cleaning, remove all cooking containers from the appliance.
- Follow all instructions shown on the appliance's display.
- After using the detergent, do not leave the detergent package in the cooking chamber.
- Never spill the detergent on the appliance's hot surface – this can irreversibly damage the stainless steel surface. The warranty does not apply to appliances damaged in this way.
- If cleaning is inadequate, fat build-up in the appliance's cooking chamber may ignite during ordinary operation.

The combi oven has six cleaning programs. Which program to use, depends on the level of soiling in the cooking chamber – see chart below.

PROGRAM	DESCRIPTION	DURATION *
	Water rinsing – Rinse with lukewarm water without using detergent.	14:53
	Express cleaning - Short cleaning of light soiling.	33:39
	Basic cleaning - Cleaning of light soiling.	50:19
	Medium cleaning - Cleaning of medium level soiling.	01:15:19
	Extra strong cleaning - Cleaning of very heavy soiling.	01:48:39
	Cooking chamber descaling	01:12:44

* The cleaning times indicated apply to size 611. These data may differ slightly with other combi oven sizes.



Depending on the size of the combi oven and the cleaning program chosen, it is also necessary to select the right amount of detergent. The amount of cleaning agent needed depends on the degree and character of the appliance's grime.

PROGRAM		SIZE OF COMBI OVEN					
		AMOUNT OF DETERGENT (units)					
		623	611	1011	1221	2011	2021
	Water rinsing*	0	0	0	0	0	0
	Express cleaning	1	1	1	2	2	3
	Basic cleaning	1	1	1	2	2	4
	Medium cleaning	1	1	1	2	2	4
	Extra strong cleaning	1	2	2	3	3	5
	Cooking chamber descaling**	1	1	1	2	2	3

* Water rinsing is done without detergent.

** Vision Descaler is used for descaling.

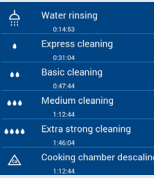
9.2 START CLEANING

1 ENTER THE CLEANING MODE	
2 SELECT THE APPROPRIATE MODE	
3 AFTER STARTING THE CLEANING PROGRAM, PRESS Wait for the detergent insert prompt.	
TO RETURN TO THE CLEANING MODE LIST, PRESS	

When Start is pressed, the combi oven automatically checks that the temperature inside the cooking chamber is not too high. If the temperature is above 80°C, the automatic process for cooling the cooking chamber will begin. If the temperature does not exceed 80°C or cooking chamber cooling has finished, your appliance will prompt you to add detergent.

 **When handling the detergent, follow all rules for working with chemical substances!**

ADDING DETERGENT



- Cut open the detergent bag at the place indicated.
- Pour the entire contents of the package on to the drain lid at the bottom of the cooking chamber. Most of the powder will fall through into the drain hole.
- close the combi oven door

The selected program will start automatically, and the screen will keep you informed about the current status of the program and the cleaning time left.

After the cleaning program ends, a signal sound is made and a message appears. Now, the combi oven is ready to be used again.

STOPPING THE CLEANING PROGRAM PREMATURELY

You can interrupt the cleaning process during the main step with the **STOP** button shown on the screen. If you do this, the combi oven will ask if you really want to stop it. If you confirm, the program will switch to rinse mode, which lasts about 16 minutes. Then the cleaning process completely stops. If you do not confirm the pause and press **No**, the process will continue where it left off.



- When the cleaning process has finished, check the cooking chamber. Remove any remaining detergent by thoroughly rinsing with the hand shower or cleaning with water. If this isn't done, the stainless-steel surface of the cooking chamber can distort and discolour when the appliance is used at high temperatures. The warranty does not cover damage caused in this way!
- Do not cleaning the combi oven using equipment that works with high water pressure.
- If the combi oven won't be used again after cleaning, we recommend leaving the door ajar, for example overnight.
- Dispose of the detergent package as usual, by putting it in a place reserved for plastic bags.
- Do not leave packages lying around freely accessible.

DESCALING THE COOKING CHAMBER

Lime scale removal is recommended when there are visible lime scale deposits in the cooking chamber (a white layer of water scale). To descale the combi oven, the special substance Vision Descaler must be used.

This substance is applied in the same way as Active Cleaner. The standard package for Vision Descaler is a plastic bucket containing 25 bags of 150 g.

10 | TABLE OF ERROR MESSAGES

When you work with the appliance, the display may show error messages. Their meanings are as follows:

ERROR	DESCRIPTION	SOLUTION
Err 10	The minimum water level was not reached in the boiler within the set time limit despite the maximum water level being reached.	The combi oven will automatically switch to the reserve injection state and it is possible to continue using it temporarily. After the combi oven is turned off and then on again, it will try to start up the boiler. If the problem reoccurs, please contact an authorised service company.
Err 11	Chamber heating element error.	The combi oven cannot continue operating. Contact an authorised service company.
Err 12	The maximum water level was not reached in the boiler within the set time limit.	The combi oven will automatically switch to the reserve injection state and it is possible to continue using it temporarily. After the combi oven is turned off and then on again, it will try to start up the boiler. If the problem reoccurs, please contact an authorised service company.
Err 13	The minimum water level was not reached in the boiler within the set time limit.	Check the water supply inlet (open tap). The combi oven can be used temporarily only in hot air mode. If the problem reoccurs, even when water supply is provided, please contact an authorised service company.
Err 15	Failure of motor heat protection. Signals motor overheating above the set limit.	Contact an authorised service company.
Err 16	The boiler was not preheated within the set time limit.	The combi oven will automatically switch to the reserve injection state and it is possible to continue using it temporarily. After the combi oven is turned off and then on again, it will try to start up the boiler. If the problem reoccurs, please contact an authorised service company.
Err 17	When draining the boiler, the water level did not fall below the minimum water level within the set time limit.	The combi oven will automatically switch to the reserve injection state and it is possible to continue using it temporarily. After the combi oven is turned off and then on again, it will try to start up the boiler. If the problem reoccurs, please contact an authorised service company.
Err 18	When draining the boiler, the water level did not fall below the maximum water level within the set time limit.	The combi oven will automatically switch to the reserve injection state and it is possible to continue using it temporarily. After the combi oven is turned off and then on again, it will try to start up the boiler. If the problem reoccurs, please contact an authorised service company.
Err 26	Flap valve error. The automatic flap valve is not working correctly.	Incorrect function of the flap valve may affect cooking results, however, it is possible to continue using the combi oven temporarily. Contact an authorised service company.
Err 31	Drain heat sensor error.	The combi oven can temporarily be used in all modes. Contact an authorised service company.
Err 33	Boiler heat sensor error.	The combi oven will automatically switch to the reserve injection state and it is possible to continue using it temporarily. After the combi oven is turned off and then on again, it will try to start up the boiler. If the problem reoccurs, please contact an authorised service company.
Err 34	Error of the 1-point temperature probe.	The combi oven can temporarily be used in all modes with the exception of the modes with a temperature probe. Contact an authorised service company.
Err 35	Chamber heat sensor error.	Error blocks work in all modes. Contact an authorised service company.
Err 36	Error of the 6-point temperature probe.	The combi oven can temporarily be used in all modes with the exception of the modes with a temperature probe. Contact an authorised service company.
Err 37	Thermistor disconnected.	Contact an authorised service company.
Err 38	Thermistor short-circuited.	Contact an authorised service company.

Err 40	Outage of the chamber thermal fuse, boiler (boiler combi ovens only), draught interrupter (only gas combi ovens with a draught interrupter) or switchboard thermal fuse.	Contact an authorised service company.
Err 41	Cooling error - overheating of electronics.	Clean the dust filter. If the error occurs repeatedly, please contact an authorised service company.
Err 42	Overheating of the boiler heating element.	The combi oven will automatically switch to the reserve injection state and it is possible to continue using it. After the combi oven is turned off and then on again, it will try to start up the boiler. If the problem reoccurs, please contact an authorised service company.
Err 60-79	Modbus communications error.	Disconnect the power supply to the combi oven (not "Standby" mode), wait 30 seconds and then turn on the combi oven again (reconnect the power supply). If the problem reoccurs, please contact an authorised service company.
Err 80-91	Frequency converter error.	If the problem reoccurs, please contact an authorised service company.
Err 95	Incorrect blower speed.	
Err 96	Lighting up error.	Check that the gas supply is open and try to start cooking again. If the problem reoccurs, please contact an authorised service company.
Err 100	System error	Contact an authorised service company.



- Only an authorized service trained and certified by the manufacturer is allowed to repair defects in the appliance. Unprofessional intervention by an unauthorized service voids the warranty!
- For the entire observation time, the combi oven must be subjected to regular inspections, tests and reviews according to the applicable regulations in the owner's country.

11 | SERVICE LIFE, DECOMMISSIONING AND WARRANTY

SERVICE LIFE

The product's service life is 10 years if the following conditions are adhered to: A regular preventative service inspection after every 12 months of operation. This inspection must be performed by service technicians from a Retigo-authorized partner company.

The user must present a list of service events.

The user must precisely follow the instructions in the operating manual.

The user must maintain and clean the appliance daily using cleaning agents recommended by Retigo.

If the appliance has automatic cleaning, cleaning agents recommended by Retigo must be used exclusively.

Training of operators by a Retigo professional cook must be documented in the service booklet or by copies of the operator training log.

If operating personnel change, training must be conducted again.

TAKING OUT OF OPERATION – DISPOSAL

For disposal of the combi oven after it has been taken out of operation, it is necessary to comply with applicable national regulations on waste disposal. The appliance contains electrical parts (electronics, transformer, halogen lamps, battery, etc.) that may harm the environment if disposed of improperly.



The combi oven and its parts MUST NOT be disposed of in communal waste!

The appliance's end user must choose among three of the following disposal options:

Disposal by RETIGO s.r.o.

Order disposal of the equipment by RETIGO by calling the telephone number +420 571 665 511 or by email at info@retigo.cz

How to prepare the combi oven for disposal:

- Professionally disconnect the electrical equipment from the media
- Place the electrical equipment on a pallet, secure it with shrink-wrap, and transport it to an appropriate loading location.



Removal and disposal are free for the end user. In cooperation with a contracted company, Retigo s.r.o. will arrange the removal and disposal of the electrical equipment in accordance with applicable law. Likewise, Retigo s.r.o. will arrange the disposal of other companies' electrical equipment of similar type and use, if Retigo s.r.o. products are replacing them.

Disposal by the appliance's distributor

Order disposal of the combi oven through the distributor, who will then arrange disposal with Retigo.

When ordering, provide the following information:

- exact address for picking up the combi oven
- contact person, telephone
- time for picking up the combi oven

Disposal on your own

If you decide to dispose of the combi oven on your own, comply with applicable national waste disposal regulations. Take the appliance's sheet metal parts to an appropriate collection facility, and put the glass into recycling bins. Take ceramic insulation and electrical parts to a specialized company authorized to treat and dispose of such waste.

WARRANTY

The warranty period is noted in the service booklet and on the warranty certificate. Demand a confirmation of the warranty from the company that installed your combi oven.

Not covered by the warranty are damage and failures caused by incorrect operation, failure to observe this operating manual, use of aggressive cleaning agents, and improper cleaning of the combi oven. Also not covered are defects caused by installation that is not in keeping with the manufacturer's recommendations, incorrect repairs, unauthorized tampering and acts of God.

retigo[®]

PERFECTION IN COOKING AND MORE...

RETIGO s.r.o.

Rope 2310

756 61 Rožnov pod Radhoštěm

Email: info@retigo.cz

Tel.: +420 571 665 511

www.retigo.cz

version TSD-15-B-MAN-EN_R04

version SW: 2.75