

INSTRUCTION MANUAL

Spray Gun

W-77 .TA

N.TA (STAINLESS STEEL FLUID PASSAGES)

Important

This manual contains IMPORTANT WARNINGS and INSTRUCTIONS. Equipment in this manual is exclusively for painting purposes. Do not use for other purposes. The operator shall be fully conversant with the requirements stated in this instruction manual including important warnings, cautions and operation and correct handling. Read and understand the instruction manual, before use and retain for reference.

Be sure to observe warnings and cautions in this instruction manual. If not, it can cause paint ejection and serious bodily injury by drawing organic solvent. Be sure to observe following \triangle marked items which are especially important.

⚠ WARNING	Indicates a potentially hazardous situation which, if not avoided, may result in serious injury or loss of life.
⚠ CAUTION	Indicates a potentially hazardous situation which, if not avoided, may result in minor or moderate injury or property damage.
Important	Indicates notes which we ask you to observe. The safety precautions in this instruction manual are the minimum necessary conditions. Follow national and local regulations regarding fire prevention, electricity and safety as well as your own company regulations.

Important specifications

Max. Pressure	0.69 MPa / 6.8 bar / 98 psi
Noise level	82.1 dB (A)
Spray condition	Recommended
Measuring point	1m backwards from gun, 1.6 m height
Max. Temperature	
Atmosphere	5°C~40°C
Air · Fluid	5°C~43°C

Main specifications

Model	Type of feed	Nozzle orifice ϕ mm (in)	Air cap set	Recommended condition				Air & fluid connection	Mass g (lbs)
				※1 Atomizing air pressure MPa (bar /PSI)	Fluid output ml/min	Air consumption l/min (cfm)	Pattern width mm(in)		
W-77-0.TA	Pressure	1.2(0.047)	0	0.35 (3.5/50)	480	430 (15.2)	380 (15.0)	1/4 (Air) 3/8 (Fluid)	550 (1.22)
W-77-0N.TA		1.4(0.054)	03		770	440 (15.6)	370 (14.6)		
W-77-03.TA		1.4(0.054)	11		230	290 (10.1)	260 (11.0)		
W-77-03N.TA					305	250 (8.8)	235 (10.0)		
W-77-11S.TA	Suction	1.8(0.071)	2		435	325 (11.5)	280 (11.0)		
W-77-11SN.TA		2.5(0.098)	3		255	290 (10.1)	270 (10.6)		
W-77-2S.TA		1.4(0.055)	11		390	340 (12.0)	315 (13.0)		
W-77-2SN.TA					485	325 (11.5)	310 (12.9)		
W-77-3S.TA	Gravity	1.8(0.071)	21						
W-77-3SN.TA		2.5(0.098)	3						
W-77-11G.TA		1.8(0.071)	21						
W-77-21G.TA	1.8(0.071)	21							
W-77-3G.TA	2.5(0.098)	3							

※1. Atomizing air pressure means air pressure at gun inlet when piston is pulled and air flows.

■ Safety precautions

WARNING

Fire and explosion

- 1. Spark and open flames are strictly prohibited.**
Paints can be highly flammable and can cause fire.
Avoid any ignition sources such as smoking, open flames, electrical goods, etc.
- 2. Never use the following HALOGENATED HYDROCARBON SOLVENTS**
which can cause cracks or dissolution on gun body (aluminum) by chemical reaction.
• unsuitable solvents : methyl chloride, dichloromethane, 1,2-dichloroethane, carbon tetrachloride, trichloroethylene, 1,1,1-trichloroethane
(Be sure that all fluids and solvents are compatible with gun parts.
We are ready to supply a material list used in the product)
- 3. Securely ground spray gun by using air hose with built-in ground wire.**
Ground wire : Less than 1 MΩ . Check the earth stability periodically.
If not, insufficient grounding can cause fire and explosion due to static electric sparking.



Improper use of equipment

- 1. Never point gun toward people or animal.**
If done, it can cause inflammation of eyes and skin or bodily injury.
- 2. Never exceed maximum operating pressure and maximum operating Temperature.**
- 3. Be sure to release air and fluid pressures before cleaning, disassembling or servicing.**
If not, remaining pressure can cause bodily injury due to improper operation or scattering cleaning liquid.
In order to release pressure, first stop supply of compressed air, fluid and thinner to spray gun.
Then remove fluid adj. knob and pull fluid needle set toward you.
- 4. Tip of fluid needle set has a sharp point. .**
Do not touch the tip of fluid needle during maintenance for the protection of the human body.



Protection of human body

- 1. Use in a well-ventilated site by using spray booth.**
If not, poor ventilation can cause organic solvent poisoning and catch fire.
- 2. Always wear protective gear (safety glasses, mask, gloves).**
If not, cleaning liquid, etc., can cause inflammation of eyes and skin.
If you feel something wrong with eyes or skin, immediately see a doctor.
- 3. Wear earplugs if necessary.**
Noise level can exceed 85dB(A), depending on operating conditions and painting site
- 4. If operators pull the trigger many times during operation, it may cause carpal tunnel syndrome.**
Be sure to take a rest if you feel tired.



Other precautions

- 1. Never alter this spray gun.**
If done, it can cause insufficient performance and failure.
- 2. Enter working areas of other equipment (robots, reciprocators, etc.) after machines are turned off.**
If not, contact with them can cause injury.
- 3. Never spray foods or chemicals through this gun.**
If done, it can cause accident by corrosion of fluid passages or adversely affect health by mixed foreign matter.
- 4. If something goes wrong, immediately stop operation and find the cause. Do not use again until you have solved the problem.**

■ How to connect

CAUTION

- Use clean air filtered through air dryer and air filter. . . . If not, dirty air can cause painting failure.
- When you use this gun for the first time after purchasing, adjust fluid needle packing set.
Slowly tighten fluid packing seat and loosen a bit when fluid needle set does not return smoothly, and adjust so that fluid needle set smoothly moves.
- If you use this gun for the first time after purchasing, clean fluid passages spraying thinner and remove rust preventive oil.
If not, remaining preventive oil can cause painting failure such as fish eyes.
- Firmly fix hose or container to spray gun. . . . If not, disconnection of hose and drop of container can cause bodily injury.

Job1. Connect an air hose to air nipple tightly.

Job2. Connect a fluid hose or a container to fluid nipple tightly.

Job3. Flush the gun fluid passage with a compatible solvent.

Job4. Pour paint into container, test spray and adjust fluid output as well as pattern width

■ How to operate

Suggested air pressure is 3.5bar (50 psi).

Recommended paint viscosity differs according to paint property and painting conditions. 15 to 23 sec. / Ford cup#4 is recommendable.

Keep fluid output as small as possible to the extent that the job will not be hindered. It will lead to better finishing with fine atomization.

Set the spray distance from the gun to the work piece as near as possible within the range of 200-250 mm (8-10 in).

The gun should be held so that it is perpendicular to the surface of the work piece at all times. Then, the gun should move in a straight and horizontal line. Arcing the gun causes uneven painting.

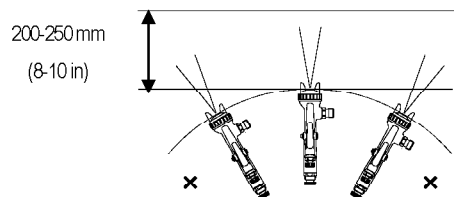

■ Maintenance and inspection

⚠ WARNING

- First release air and pressure fully according to item No. 3 of "Improper use of equipment" of WARNING on page 2.
- Tip of fluid needle set has a sharp point. Do not touch the tip of needle valve at the maintenance for protection of the human body.
- Be careful not to damage the tip of fluid nozzle or must not put your hand on it.
- Only an experienced person who is fully conversant with the equipment can do maintenance and inspection.

⚠ CAUTION

- Never use commercial or other parts instead of ANEST IWATA original spare parts.
- Never immerse the whole gun into liquid such as thinner.
- Never damage holes of air cap a fluid nozzle and fluid needle.

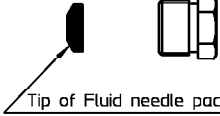
Step-by-step procedure	Important
1. Pour remaining paint to another container. Clean fluid passages and air cap set.. Spray a small amount of thinner to clean fluid passages.	1. Incomplete cleaning can fail pattern shape and uniform particles. Especially clean fully and promptly two-component paint after use.
2. Clean each section with brush soaked with thinner and wipe out with waste cloth.	2. Do not immerse the whole gun in thinner. If done, it can damage parts. When cleaning, never scratch each hole of air cap set and fluid nozzle, and fluid needle set.
3. Before disassembly, fully clean fluid passages.	3. During disassembly, do not scratch seat section.
(1) Disassemble fluid nozzle. Use ring spanner, box wrench or optional exclusive spanner (code No.035386000) to disassemble fluid nozzle.	(1) Remove fluid nozzle after removing fluid needle set or while keeping fluid needle pulled, in order to protect seat section.
(2) Disassemble fluid needle set. Remove fluid adj. knob and pull out fluid needle set from gun body. Pay attention so that spring does not suddenly fly out since fluid adj. knob is strongly pushed by fluid needle spring and piston spring.	(2) Pull fluid needle set after loosening fluid needle packing set to protect fluid needle packing set.. Be careful when handing tip of fluid needle set since it is sharp.
4. To adjust fluid needle packing set, while keeping fluid needle set inserted, tighten fluid needle packing seat by hand and then tighten further by spanner. When replacing fluid needle packing set, be careful that the top old packing does not remain inside 	4. Too much tightening of fluid needle packing set can cause bad movement of fluid needle set and fluid leakage from the tip of fluid needle set.
6. Turn pattern adj. knob or air adj. knob counterclockwise to fully open. And then tighten pattern adj set or air adj. set.	6. If pattern adj. Knob or air adj. Knob is not fully opened, tip of it can contact and damage fluid nozzle and cause seizure of thread.
Where to inspect	Parts replacement standard
1. Each hole passage of air cap and fluid nozzle	Replace if it is crushed or deformed.
2. Packing and O ring	Replace if it is deformed or worn out.
3. Leakage from seat section between fluid nozzle and fluid needle set	Replace them if leakage does not stop after fully cleaning fluid nozzle and fluid needle set. If you replace fluid nozzle or fluid needle set only, fully match them and confirm that there is no leakage.

■ Parts list

When ordering parts, specify gun's model, part name with ref.No. and marked No. of air cap set, fluid nozzle and fluid needle.

When replacing fluid nozzle or/and fluid needle for pressure feed application, please order nozzle needle set.

Fluid nozzle fluid needle set combination

Type of feed	Fluid nozzle		Fluid needle set		
	Orifice Φmm (in)	Mark		Mark	
Pressure	Φ 1.2 (0.047)	0	0N	0	0N
	Φ 1.4 (0.055)	03	03N	0	0N
Suction Gravity	Φ 1.4 (0.055)	11	11N	1	1N
	Φ 1.8 (0.071)	21	2N	2	2N
	Φ 2.5 (0.098)	3	3N	3	3N





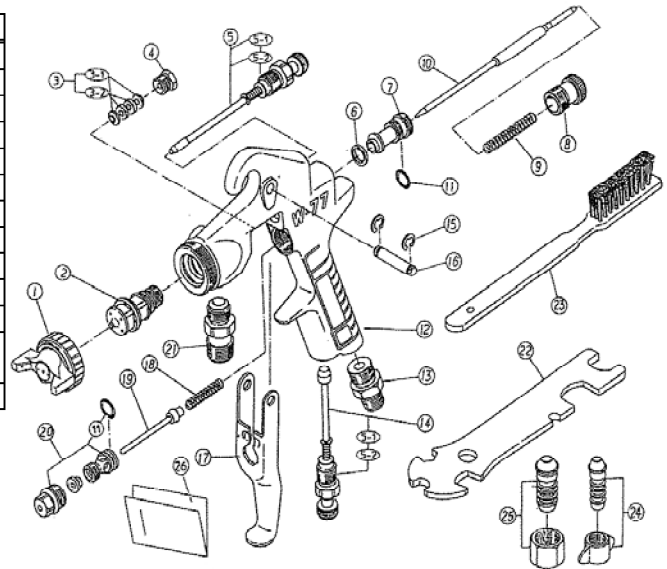

Parts list

No.	Description	Q'ty	No.	Description	Q'ty
1	Air cap set	1	14	Air adj. valve set	1
2	Fluid nozzle	1	15	Stop ring	2
3	packing set	1	16	Trigger stud	1
3-1	Fluid needle packing	2	17	Trigger	1
3-2		2	18	Air valve spring	1
4	Needle packing nut	1	19	Air valve	1
5	Spread adj. valve set	1	20	Air valve seat set	1
5-1	O ring	1	21	Fluid nipple	1
5-2	Stopper	1	22	Spanner	1
6	Gasket	1	23	Brush	1
7	Fluid needle guide	1	24	Air hose joint set	1
8	Fluid adj. knob	1	25	Fluid hose joint set (only pressure feed type)	1
9	Fluid needle spring	1	24	Instruction manual	1
10	Fluid needle set	1			
11	O ring	1			
12	Gun body	1			
13	Air nipple	1			

◆ Marked parts are wearable parts.



Troubleshooting

Spray Pattern	Problems	Remedies
 Fluttering	1. Air enters between fluid nozzle and tapered seat of gun body. 2. Air is drawn from fluid needle packing set. 3. Air enters at fluid container fitting nut or fluid hose joint.	1. Remove fluid nozzle to clean seat. If it is damaged, replace nozzle. 2. Tighten fluid needle packing. 3. Fully tighten joint section.
 Crescent	1. Paint buildup on air cap partially clogs horn holes. Air pressure from both horns differs.	1. Remove obstructions from horn holes with attached brush. But do not use metal objects to clean horn holes.
 Inclined	1. Paint buildup or damage on fluid nozzle circumference and air cap center. 2. Fluid nozzle is not properly fitted.	1. Remove obstructions. Replace if damaged. 2. Remove fluid nozzle and clean seat section.
 Split	1. Paint viscosity too low. 2. Fluid output too high.	1. Add paint to increase viscosity. 2. Tighten fluid adj. knob to reduce fluid output. Or turn pattern adj. valve set clockwise.
 Heavy Center	1. Paint viscosity is too high. 2. Fluid output is too low.	1. Add thinner to reduce viscosity. 2. Turn fluid adj. valve knob counter-clockwise to increase fluid output.
 Spit	1. Fluid nozzle and fluid needle set are not seated properly. 2. The first-stage travel of trigger (when only air discharges) decreases. 3. Paint buildup inside air cap set.	1. Clean or replace fluid nozzle and fluid needle set. 2. Replace fluid nozzle and fluid needle set. 3. Clean air cap set.

R1 : retighten R2 : adjust R3 : clean R4 : replace parts

Problem	Where it occurred	Parts to be checked	Cause	Remedy			
				R1	R2	R3	R4
Air leaks (from tip of air cap)	Air valve set	Air valve	* Dirt or damage on seat			○	○
		Air valve seat set	* Dirt or damage on seat			○	○
		O ring	* Wear on air valve spring * Damage or deteriorated				○
Paint leaks	Fluid nozzle	Fluid nozzle ~ fluid needle set	* Dirt, damage, wear on seat * Loose fluid needle adj. knob * Wear on needle spring		○		○
		Fluid nozzle ~ gun body	* Insufficient tightening * Dirt or damage on seat	○			○
		Fluid needle ~ packing set	* Needle does not return due to packing set too tight * Needle does not return due to paint buildup on fluid needle		○	○	○
	Fluid needle	Needle packing set ~ needle set	* Wear	○			○
		Packing seat	* Insufficient tightening	○			
Paint does not flow	Tip of gun	Fluid adj. knob	* Insufficient opening		○		
		Tip hole of nozzle	* Clogged			○	
		Paint filter	* Clogged			○	○



ANEST IWATA Corporation

3176, Shinyosida-cho, Kohoku-ku, Yokohama, 223-8501, Japan

Code No. 03299906

No. 258-07