

Savi 7210/7220 Office
for desk phone

Headset
Advisor

Contents

- Overview **3**
 - Headset overview **3**
 - Base overview **4**
 - Accessories **5**
- Hook up system **6**
 - Desk phone setup details **6**
- Subscribe headset to base **9**
 - Automatic secure subscription **9**
 - Manual over-the-air subscription **9**
 - Ending subscription **9**
- Fit and charge **10**
 - Wear on the right or left **10**
 - Charge your headset **10**
- System basics **11**
 - Power on your headset **11**
 - Adjust volume **11**
 - Make, answer, end calls **11**
- Troubleshooting **12**
 - Headset **12**
 - Desk phone **13**
- Support **14**

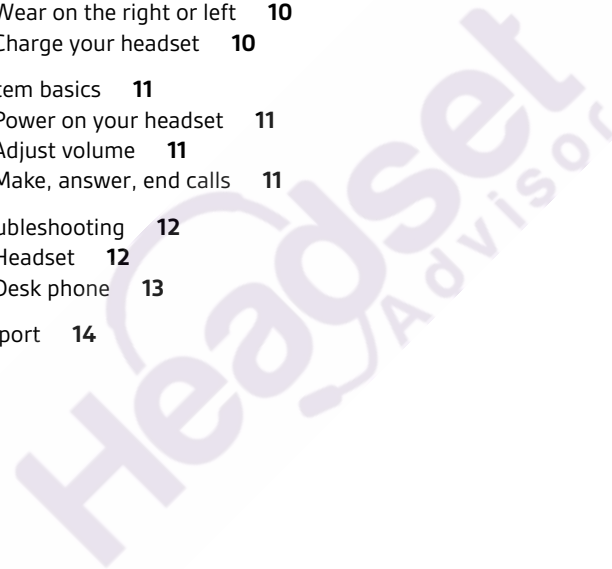

Overview

Headset overview

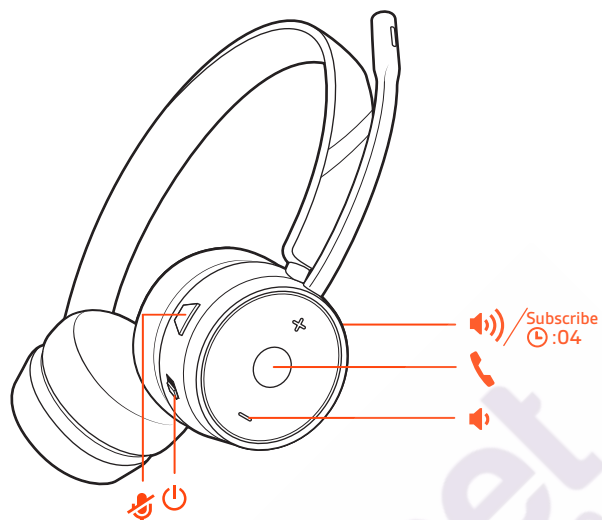

	Mute/unmute
	Power
	Subscribe
	Volume up
	Volume down
	Call

NOTE **Functionality varies by application. May not function with web-based apps.

Base overview

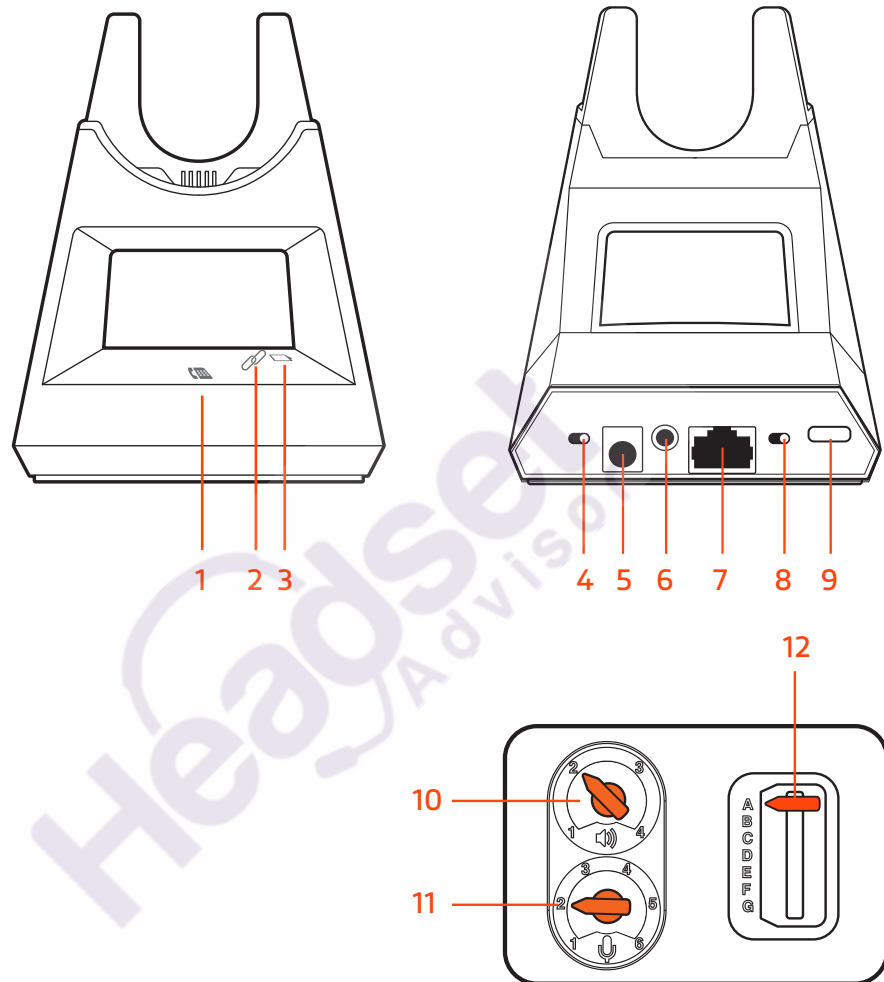

- 1 Desk phone LED
- 2 Subscribe LED
- 3 Charging LED
- 4 Wideband/narrowband audio switch
- 5 Power jack
- 6 Handset lifter jack

- 7 Telephone interface cable jack
- 8 Auto answer
- 9 Subscription button
- 10 Desk phone listening volume
- 11 Desk phone speaking volume
- 12 Desk phone configuration switch

Accessories

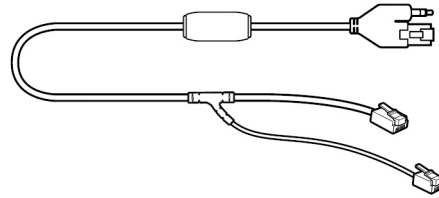

1

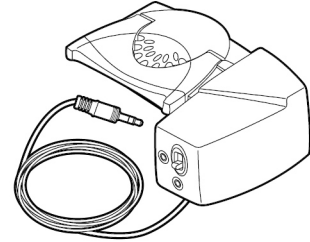

2

- 1 Electronic hookswitch cable (EHS cable)** Electronically and automatically answers/ends a desk phone call. Enables remote call control with your headset.
- 2 HL10 lifter** Automatically lifts handset and returns it to the cradle. Enables remote call control with your headset.

Headset
Advisor

Hook up system

Using the diagram, connect your headset system.

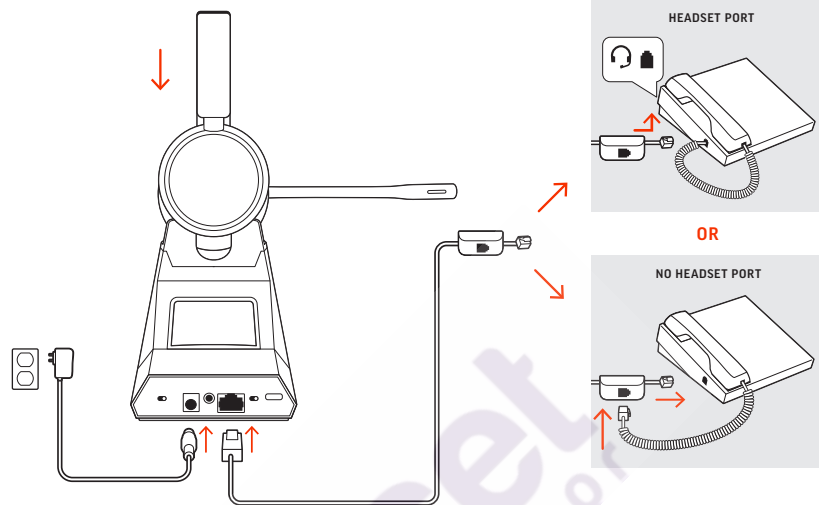

Desk phone setup details

Choose a desk phone setup A, B, C or D and connect cables.

A Desk phone with dedicated headset port

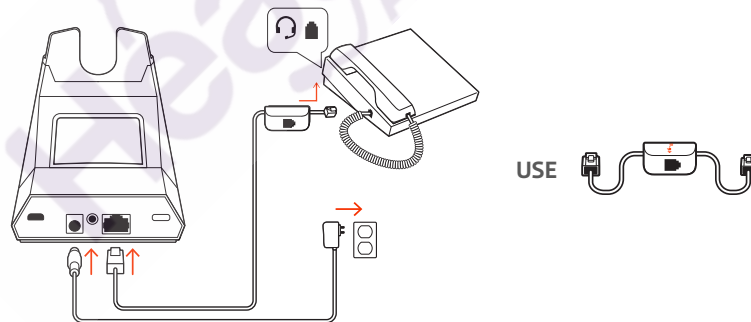

- Connect one end of the telephone interface cable to the back of the base
- Connect the other end of the telephone interface cable into the dedicated headset port on the desk phone
- Adjust the configuration switch on the bottom of the base to default A, which works for most phones. Use configuration D for Cisco phones.

NOTE Use this setup if you are not using the HL10 lifter or EHS cable. In this configuration, press both the headset button on your desk phone and the call control button on the headset to answer or end calls.

B Desk phone (standard)

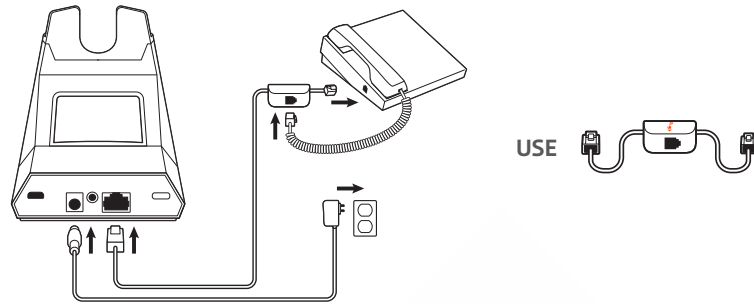

- Connect one end of the telephone interface cable to the back of the base
- Disconnect the handset coil cord from the base of the desk phone and re-connect it to the telephone interface cable junction box
- Finally connect the remaining end of the telephone interface cable into the open handset port on the desk phone
- Adjust the configuration switch on the bottom of the base to default **A**, which works for most phones. Use configuration **D** for Cisco phones.

NOTE Use this setup if you are not using the HL10 lifter or EHS cable and your desk phone does not have a dedicated headset port. In this configuration, manually remove the handset on your desk phone and press the call control button on the headset to answer or end calls.

C Desk phone + EHS cable (sold separately)

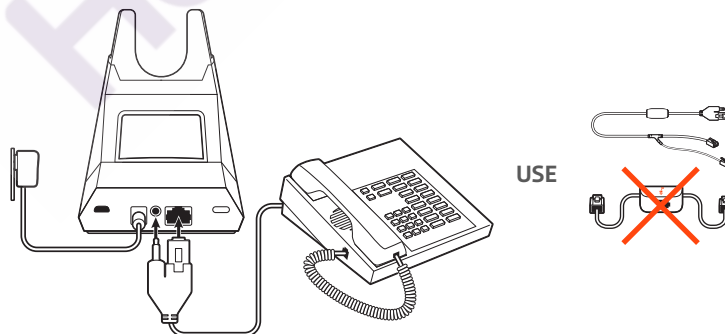

- Adjust the configuration switch on the bottom of the base to default **A**, which works for most phones.

D Desk phone + HL10 lifter (sold separately)

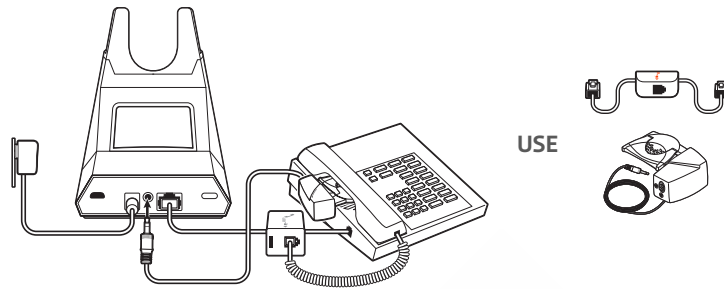

- Adjust the configuration switch on the bottom of the base to default **A**, which works for most phones. Use configuration **D** for Cisco phones.

Headset
Advisor

Subscribe headset to base

The headset and base that came in the box are subscribed (connected) to each other. However, if you wish to use a new headset or need to restore subscription to your current headset, the units can be subscribed to each other by the following two methods.

Automatic secure subscription

With your system idle, docking a headset will automatically subscribe it to the base, making it the primary headset. The Power on/Subscription LED will flash white during subscription process and become solid white when the new subscription is established.

Manual over-the-air subscription

- 1 With your system idle and your headset undocked, press and hold the Subscription button on the back of the base for 4 seconds. The subscription LED on the display panel will flash green.
- 2 Press and hold the Volume up button on the headset for 4 seconds until the headset LED turns solid white. When the subscription LED on the base becomes solid green, the headset and base are subscribed to one another.

NOTE *If the subscription process times out after 2 minutes or if the subscription process fails, the subscription LED on the base will go dark for 3 seconds and then re-illuminate steadily to indicate power is applied to the base. If this occurs, try to re-subscribe the headset again.*

Ending subscription

If the base is in subscription mode and you want to stop the base from searching for a headset, press the subscription button again. The subscription LED on the base will go dark for three seconds and then re-illuminate steadily to indicate power is applied to the base.

Fit and charge

Wear on the right or left

To position the microphone on the right or left side, rotate the microphone boom up and over. Gently bend the boom so it is approximately 2 finger widths from the corner of your mouth.

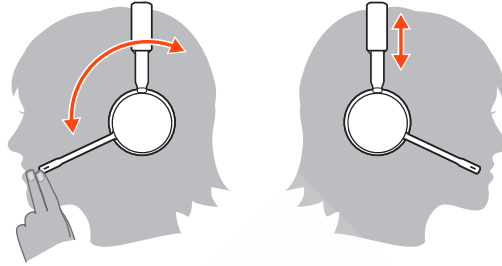

Charge your headset

Place the headset in the charge cradle. The charging LED will flash green when charging the headset and turn off when the headset is fully charged. Charge for at least 20 minutes prior to the first use. Charge for 3 hours to get 8 hours of talk time.

Headset
Advisor

System basics

Power on your headset

To turn on the headset, slide the Power  button.

Adjust volume

- **Headset volume** Fine-tune your headset volume by adjusting the volume controls.
- **Desk phone volume** When you are on a desk phone call and your voice is too quiet/loud, adjust the microphone volume on the bottom of the base. If your caller's voice is too loud/quiet on a desk phone call, adjust the base volume dial.
- **Base ringtone volume** Adjust the base ringtone volume on the bottom of the base. This ringtone alerts you if you are not wearing your headset and a call comes in. There are 4 base ringer settings: off, low, medium and high.

Make, answer, end calls

Make a call (deskphone)

- 1 Tap the headset call button. The desk phone  icon lights up on your base display. You should hear a dial tone in your headset.

NOTE Press your phone's Headset  button or manually remove the handset if you don't have an HL10 lifter or EHS cable.

TIP If you do not hear a dial tone, turn over the base and adjust the switch (A--G). "A" works for the majority of desk phones. "D" works for Cisco phones.

- 2 Dial from your desk phone.

End/take a call

To answer or end a call, tap the headset Call button.

NOTE If you don't have an HL10 lifter or EHS cable, press your phone's Headset  button or remove the handset when answering a call and hang up when ending a call.

Mute a call

Tap the Mute button to mute a call, you hear 3 quick tones. The corresponding base icon turns red. Tap again to unmute.

Hold a call

To hold an active call, press the Volume Up or Down button for 4 seconds. Press the Call button to resume a held call.

Switch between calls (flash)

To switch between calls, press the Volume Up or Down button for 4 seconds.

Auto-answer

Automatically answer an incoming call by removing the headset from the charging cradle by sliding the Auto-answer button  to the left.

Troubleshooting

Headset

I can't hear a dial tone in the headset.

- Make sure your headset is charged.
- Make sure your headset is subscribed to base. See [Subscribe headset to base](#).
- Adjust the configuration switch (A--F) on the bottom of the base until a dial tone is heard. The default **A** works for most phones. **ATTENTION** Use configuration **D** for Cisco phones. Cisco phones connected with EHS cable use configuration **A**.
- Make sure your desk phone is connected correctly to your base. See [Desk phone setup details on page 6](#)Desk phone setup details.
- If your base is connected to your desk phone's dedicated headset port, press the desk phone's headset button to hear a dial tone.
- If your base is connected to your desk phone's dedicated headset port, press the desk phone's headset button and base's desk phone button to hear a dial tone.
- If your base is connected to your handset port, manually remove the handset to hear a dial tone (if you do not have an EHS cable or HL10 lifter).
- Make sure your HL10 lifter is lifting the handset high enough to operate the hookswitch; set to a higher setting if necessary.
- Adjust the headset's listening volume. See [Adjust volume](#).
- If the volume is still too low, adjust the desk phone listening volume on the base. See [Adjust volume](#).

I hear static.

- Make sure there is at least 12 inches between your base and your computer, and 6 inches between your base and your telephone. If adjusting the distance doesn't help, your headset is going out of range, move closer to the base. See [Position Your Base](#).

The sound is distorted.

- Lower the desk phone speaking volume and/or desk phone listening volume on the base. For most telephones the correct setting is position 2. See [Adjust volume](#).
- If your desk phone has a volume control, lower until the distortion disappears.
- If the distortion is still present, adjust the headset volume control to lower the headset speaker volume. See [Adjust volume](#).
- Make sure there is 12 inches between your base and your computer, and 6 inches between your base and your telephone. See [Position Your Base](#).

I hear echo in the headset.

- Lower the desk phone speaking volume and/or desk phone listening volume on the base. For most telephones the correct setting is position 2. See [Adjust volume](#).
- If the audio level is too low in this position, increase the headset volume. See [Adjust volume](#).
- If your speaking volume is too low for your listener in this position, adjust the position of the headset to make sure the microphone is as close as possible to your mouth.

People I talk to can hear a buzz in the background.

- Move the base further away from your phone. See [Position Your Base](#).
- If the base power supply is plugged into a power strip, plug it into the wall directly.

Desk phone

The handset lifter is installed but does not lift the handset.

- Be sure the handset lifter power cord is firmly pushed into the handset lifter jack on the base.

I can't hear my desk phone dial tone in the headset.

- Adjust the configuration switch (A--F) on the bottom of the base until a dial tone is heard. The default **A** works for most phones. **ATTENTION** Use configuration **D** for Cisco phones. Cisco phones connected with EHS cable use configuration **A**.
 - Make sure your desk phone is connected correctly to your base. See [Desk phone setup details](#).
 - If your base is connected to your desk phone's dedicated headset port, press the desk phone's headset button to hear a dial tone.
 - If your base is connected to your desk phone's dedicated headset port, press the desk phone's headset button and base's desk phone button to hear a dial tone.
 - If your base is connected to your handset port, manually remove the handset to hear a dial tone (if you do not have an EHS cable or HL10 lifter).
-



NEED MORE HELP?

plantronics.com/support

Plantronics, Inc.

345 Encinal Street
Santa Cruz, CA 95060
United States

Plantronics B.V.

Scorpius 171
2132 LR Hoofddorp
Netherlands

© 2019 Plantronics, Inc. All rights reserved. Poly, the propeller design, and the Poly logo are trademarks of Plantronics, Inc. All other trademarks are the property of their respective owners.

215231-06 11.19