

Jabra Engage 65



User manual

GN Making Life Sound Better



Questions?
Click to Live Chat

A third-party certification according to ISO 14024



Toward sustainable IT products

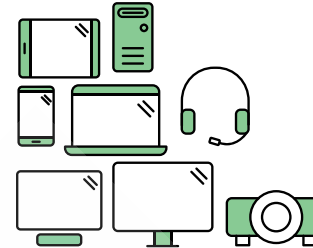

Say hello to a more sustainable product

IT products are associated with a wide range of sustainability risks throughout their life cycle. Human rights violations are common in the factories. Harmful substances are used both in products and their manufacture. Products can often have a short lifespan because of poor ergonomics, low quality and when they are not able to be repaired or upgraded.

This product is a better choice. It meets all the criteria in TCO Certified, the world's most comprehensive sustainability certification for IT products. Thank you for making a responsible product choice, that help drive progress towards a more sustainable future!

Criteria in TCO Certified have a life-cycle perspective and balance environmental and social responsibility. Conformity is verified by independent and approved verifiers that specialize in IT products, social responsibility or other sustainability issues. Verification is done both before and after the certificate is issued, covering the entire validity period. The process also includes ensuring that corrective actions are implemented in all cases of factory non-conformities. And last but not least, to make sure that the certification and independent verification is accurate, both TCO Certified and the verifiers are reviewed regularly.

Want to know more?

Read information about TCO Certified, full criteria documents, news and updates at tcocertified.com. On the website you'll also find our Product Finder, which presents a complete, searchable listing of certified products.

- 1. Welcome.....6
- 2. What's in the box.....7
 - 2.1 Stereo variant
 - 2.2 Mono variant
 - 2.3 Convertible variant
- 3. How to wear..... 10
 - 3.1 Stereo/Mono headset
 - 3.2 Convertible headset
 - 3.3 How to change the convertible headset EarGel
 - 3.4 How to change the convertible headset EarHook
 - 3.5 How to change the convertible headset wearing style
- 4. How to charge..... 14
 - 4.1 Connect to power
 - 4.2 Charge the headset
 - 4.3 Headset PowerNap
- 5. How to connect..... 17
 - 5.1 Connect to a desk phone with a headset port
 - 5.2 Connect to a desk phone without a headset port
 - 5.3 Connect to a computer
 - 5.4 Connect headset to a computer

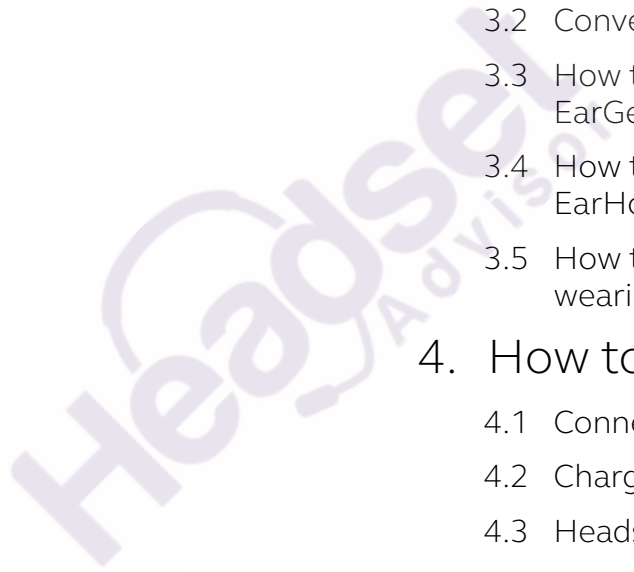

© 2018 GN Audio A/S. All rights reserved. Jabra® is a trademark of GN Audio A/S.

Made in China

MODEL: Model: WHB051BS
WHB050HS
WHB051HS



Declaration of Conformity can be found on
www.jabra.com/doc

6. How to use	21
6.1 Stereo/Mono headset overview	
6.2 Convertible headset overview	
6.3 Base overview	
6.4 Base status LEDs	
6.5 How to change voice prompt language	
6.6 How to adjust the microphone volume for desk phone calls	
6.7 How to find a dial tone for desk phones	
6.8 How to add a new primary headset	
6.9 How to reset	
7. How to make calls	29
7.1 Basic call usage	
7.2 Merge calls	
7.3 Conference calls	
7.4 Transfer a call from desk phone to headset	
7.5 Transfer a call from headset to desk phone	
7.6 Multiple call handling	
8. How to change settings.....	38
9. Jabra Direct.....	40
9.1 Firmware update	
10.Support.....	41
10.1 FAQ	
10.2 How to care for your device	
10.3 Replacement accessories	

1. Welcome

Thank you for using the Jabra Engage 65. We hope you will enjoy it!

Jabra Engage 65 features

- **Flexible connectivity**
Connect to desk phone and computer
- **World's lightest DECT headset**
18 grams (convertible)
- **Avoid disturbances**
Built-in Busylight
- **Use all day long**
Up to 13 hours talk time (stereo/mono)
Up to 9 hours talk time (convertible)
- **Take calls anywhere in the office**
Up to 150 meters/490 feet range (stereo/mono)
Up to 100 meters/325 feet range (convertible)
- **Secure confidential calls**
DECT AES 256 bit encryption

2. What's in the box

The Jabra Engage 65 comes with one of three different headset styles: stereo, mono, and convertible.

2.1 Stereo variant

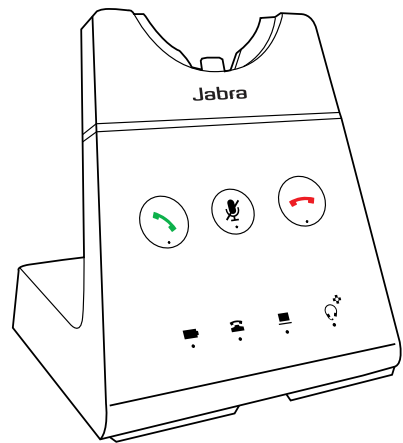

Base



Stereo headset

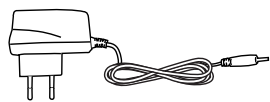

Power cable



Micro-USB cable

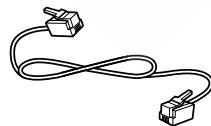

Telephone cable

2.2 Mono variant

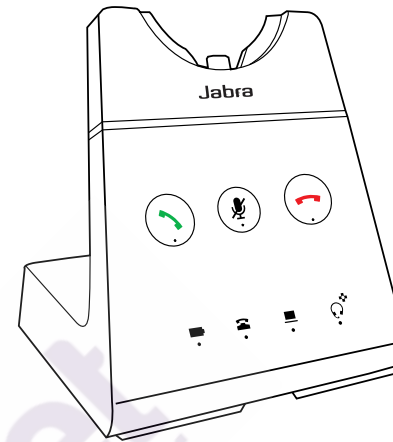

Base

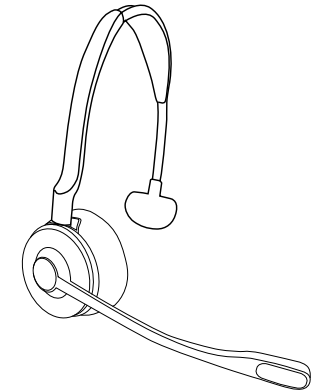

Mono headset

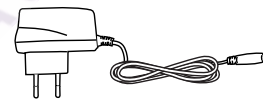

Power cable



Micro-USB cable

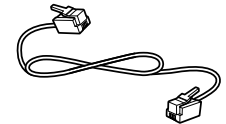

Telephone cable

2.3 Convertible variant

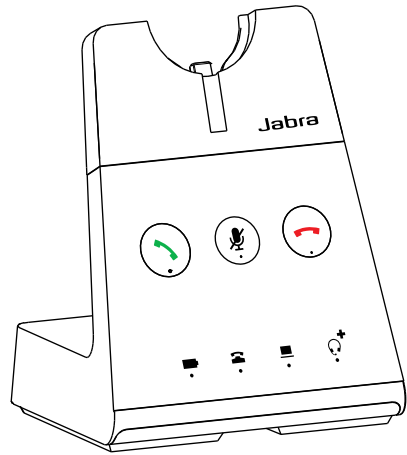

Base

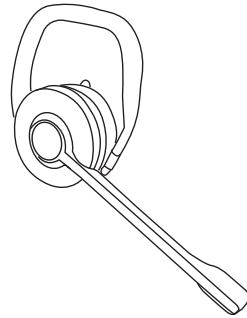

Convertible headset

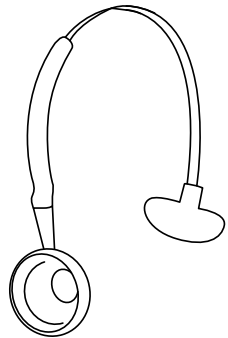

Headband

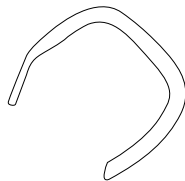

EarHook

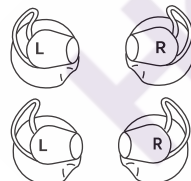

EarGels

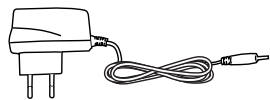

Power cable



Micro-USB cable

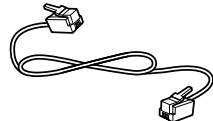

Telephone cable

3. How to wear

3.1 Stereo/Mono headset

The headset can be worn with the microphone on the left or the right.



3.2 Convertible headset

The headset can be worn on the left or the right ear.

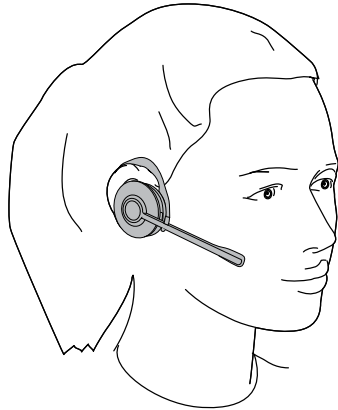

3.3 How to change the convertible headset EarGel

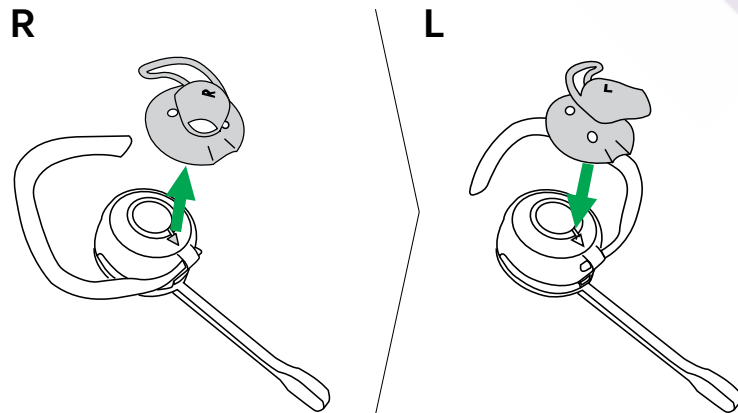
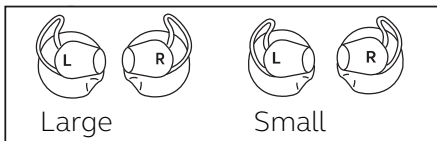

3.4 How to change the convertible headset EarHook

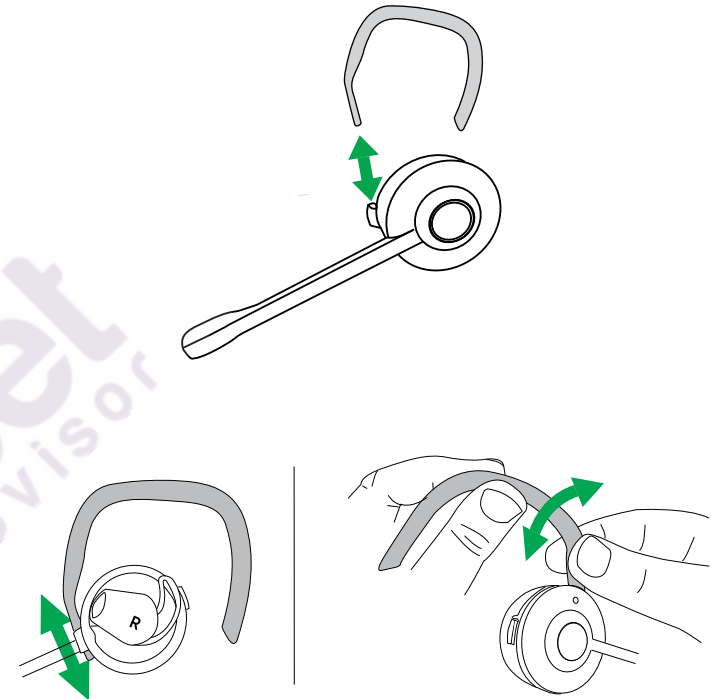

The EarHooks are flexible, and can be bent to suit your ear for a secure and comfortable fit.

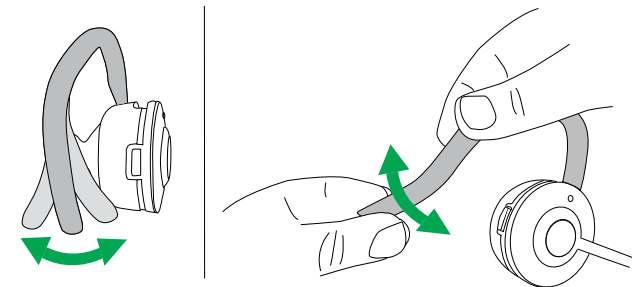

3.5 How to change the convertible headset wearing style

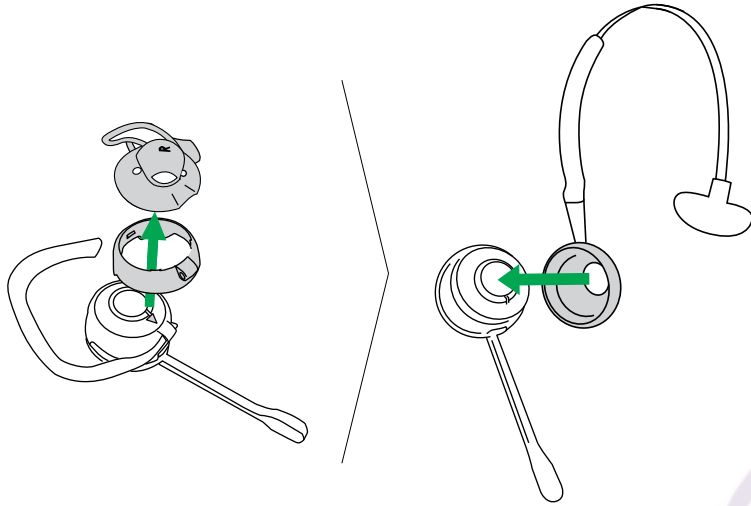

4. How to charge

4.1 Connect to power

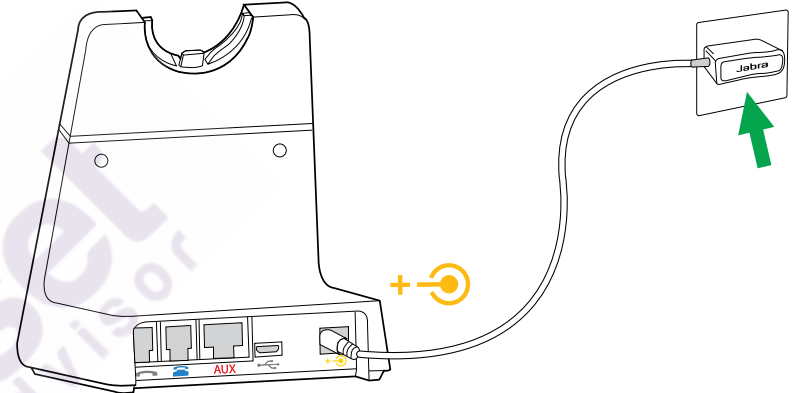

Plug the base into a power supply using the supplied power cable.

It is recommended to connect the telephone or computer cables before connecting the base to a power supply (see Chapter 5 for more information).

4.2 Charge the headset

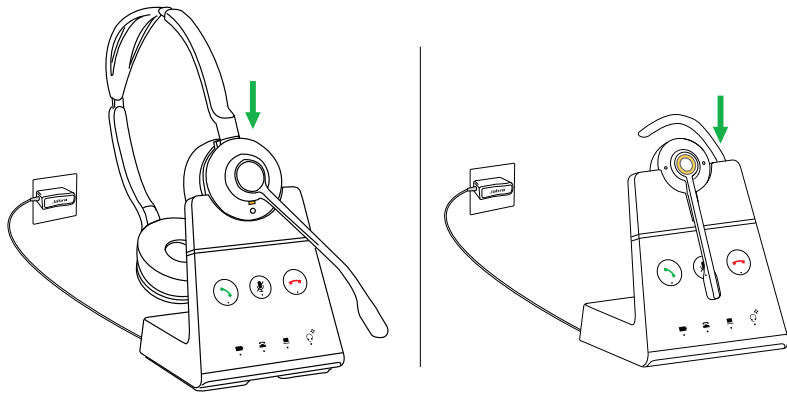

The headset will charge whenever it is docked in a base that is connected to a power supply. The status LED on the headset and the battery icon on the base will pulse to indicate the headset is charging.

The stereo/mono headsets have up to 13 hours of battery, and the convertible headset has up to 9 hours of battery.

All headsets take approx. 1.5 hours to fast charge to full. 40% of the battery will charge in approx. 30 minutes.

4.3 Headset PowerNap

To conserve battery, the headset will automatically power off when it has not been docked for 30 minutes, has not been moved, and is not in use.

To end PowerNap, either move the headset (the headset has a built-in motion sensor), press any button on the headset (must be configured in Jabra Direct), or dock the headset in the base.

PowerNap can be permanently turned off using Jabra Direct.

5. How to connect

5.1 Connect to a desk phone with a headset port

This type of desk phone has a dedicated headset port. These phones typically have a button on the front panel for switching between the desk phone handset and the headset.

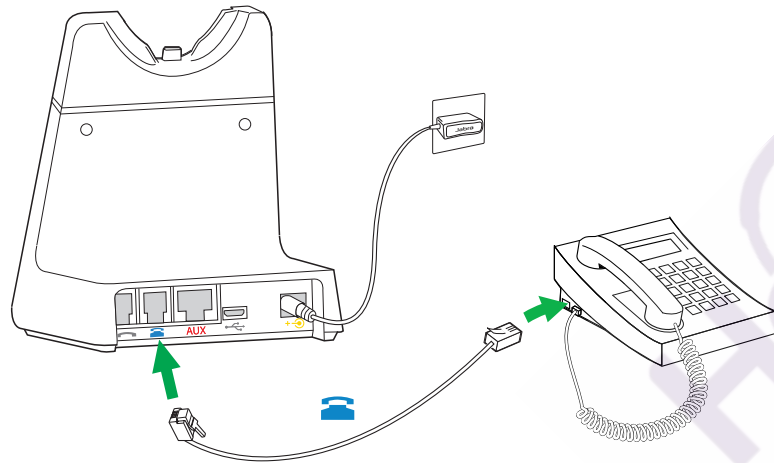



1. Plug the supplied telephone cable into the port marked  on the base, and into the headset port on the desk phone.
2. Plug the base into a power supply using the supplied power cable.

Note: For more assistance with your specific desk phone, visit www.jabra.com/compatibilityguide.

5.2 Connect to a desk phone without a headset port

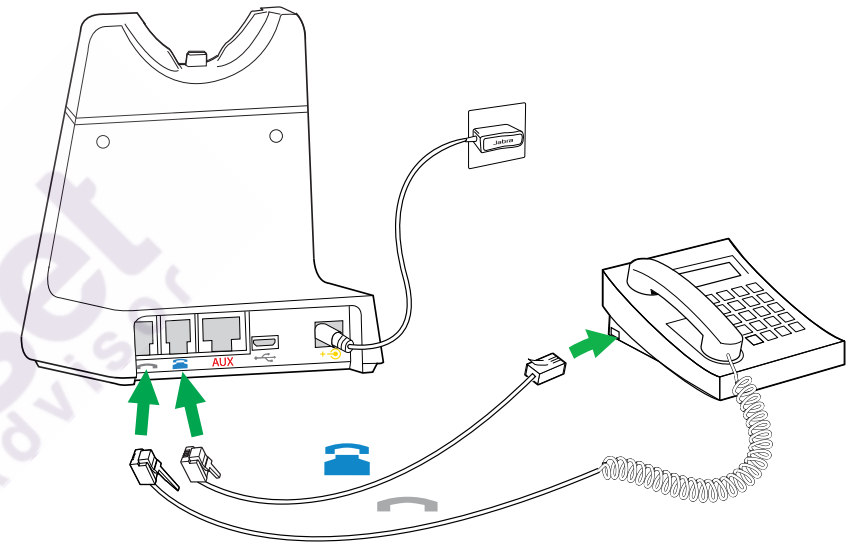
This type of desk phone does not have a dedicated headset port.



1. Unplug the handset cable from the handset port on the desk phone, and plug it into the  port on the base.
2. Plug the supplied telephone cable into the port marked  on the base, and into the handset port on the desk phone.
3. Plug the base into a power supply using the supplied power cable.

Note: For more assistance with your specific desk phone, visit www.jabra.com/compatibilityguide.

5.3 Connect to a computer

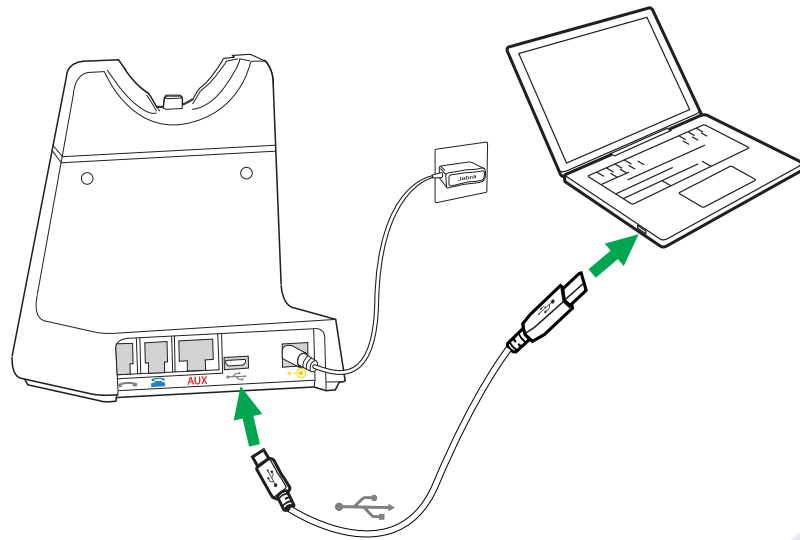

1. Plug the supplied micro-USB cable into the port marked  on the base, and into an available USB port on your computer.
2. Plug the base into a power supply using the supplied power cable.
3. Ensure the Jabra Engage 65 is set as the default playback device and recording device in your operating system's sound settings, and/or your preferred softphone (e.g. Skype for Business). It is recommended to download and install Jabra Direct from jabra.com/direct.

5.4 Connect headset to a computer

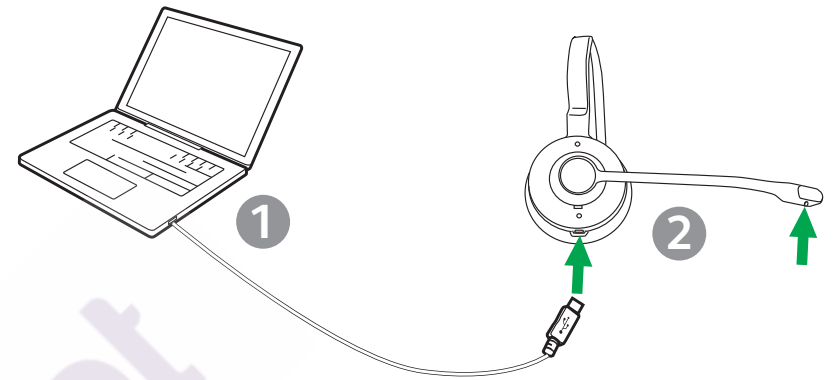

1. Plug the supplied micro-USB cable into an available USB port on your computer.
2. Press and hold either the Volume up, or Volume down, or Mute button on the headset while plugging the other end of the micro-USB cable into the headset. Once the LED on the headset stops flashing green, release the button.
3. The headset can now be selected as an audio playback device on the computer.

6. How to use

6.1 Stereo/Mono headset overview

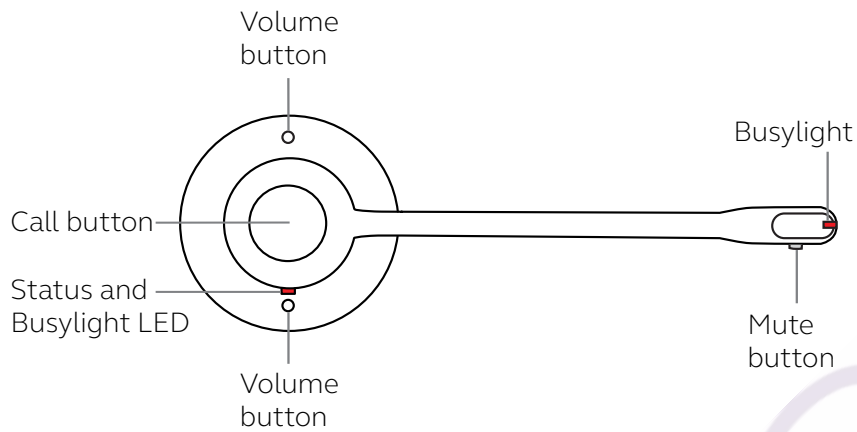

6.2 Convertible headset overview

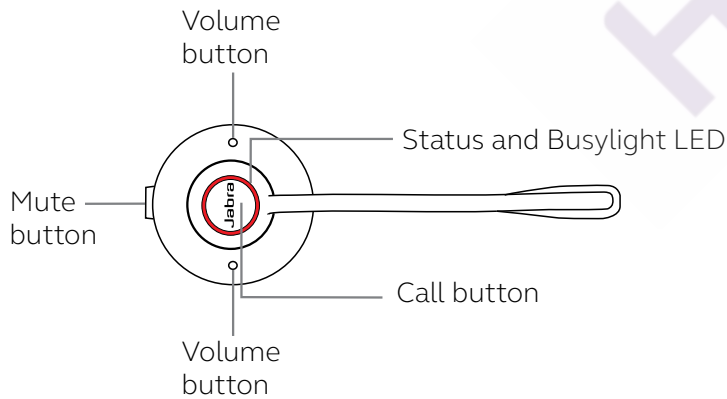

6.3 Base overview

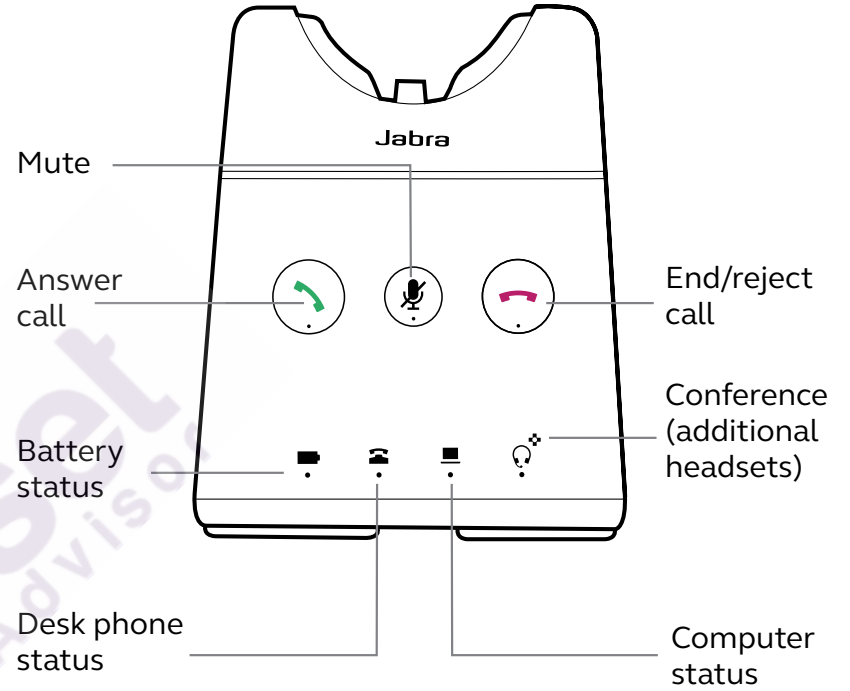

6.4 Base status LEDs

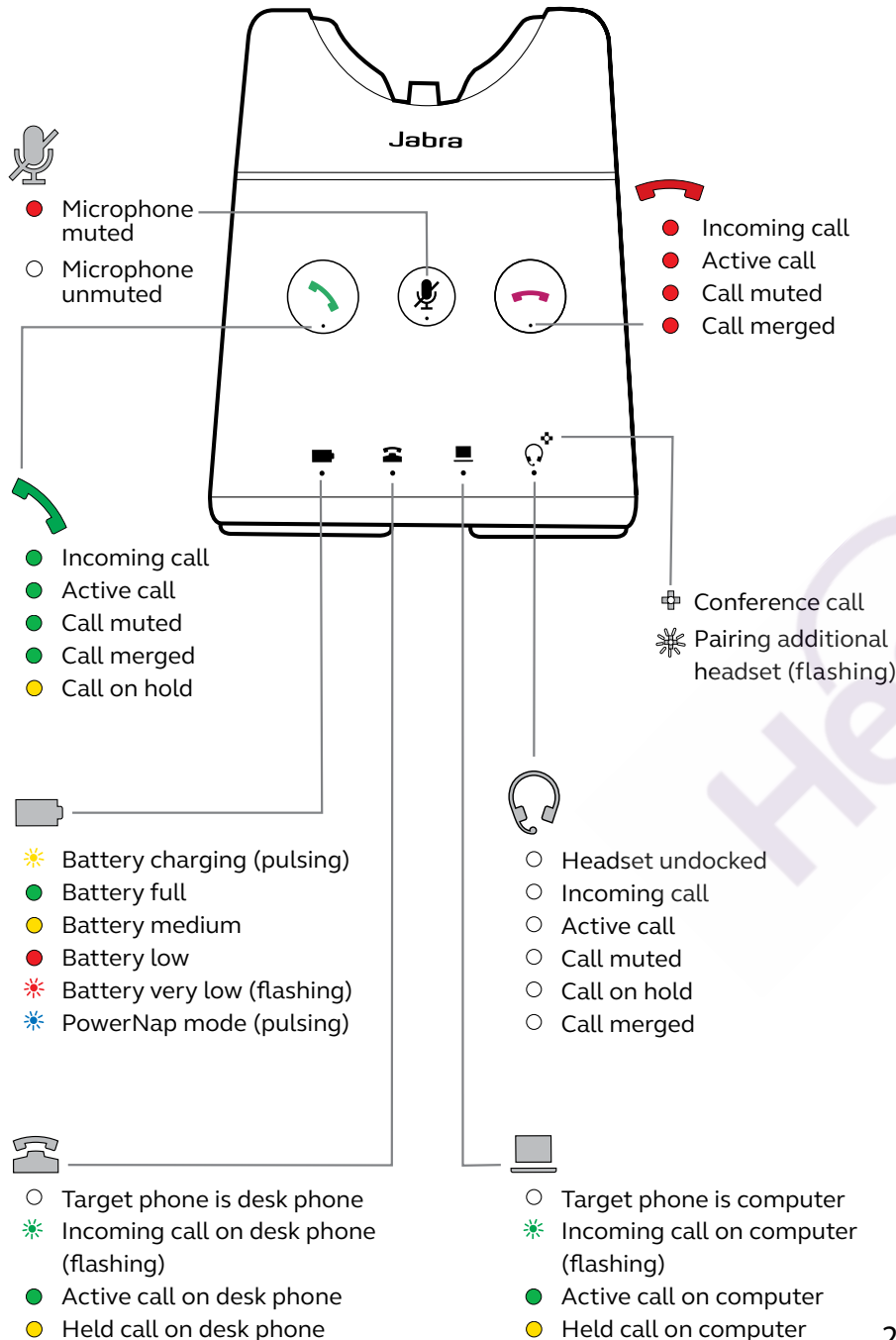

6.5 How to change voice prompt language

There are 5 available languages for the headset voice prompts: English, German, French, Japanese, and Spanish.

To change language:

1. When not on a call, hold both volume buttons (2 secs) on the headset to access the voice-guided settings menu. The first available setting is the voice prompt language.
2. Press the **Volume** buttons to cycle through the available languages.
3. Press the **Call** button to accept the language.
4. Hold both volume buttons (2 secs) on the headset to exit the voice-guided settings menu. The base will reboot and the new setting will be saved.

6.6 How to adjust the microphone volume for desk phone calls

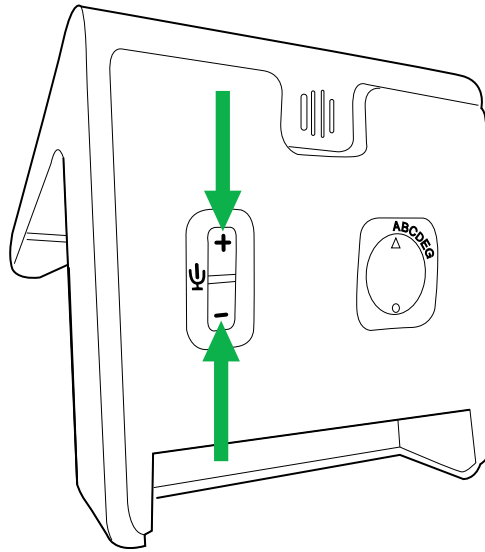

To adjust the desk phone microphone volume, press + or - buttons, located on the bottom of the base.

6.7 How to find a dial tone for desk phones

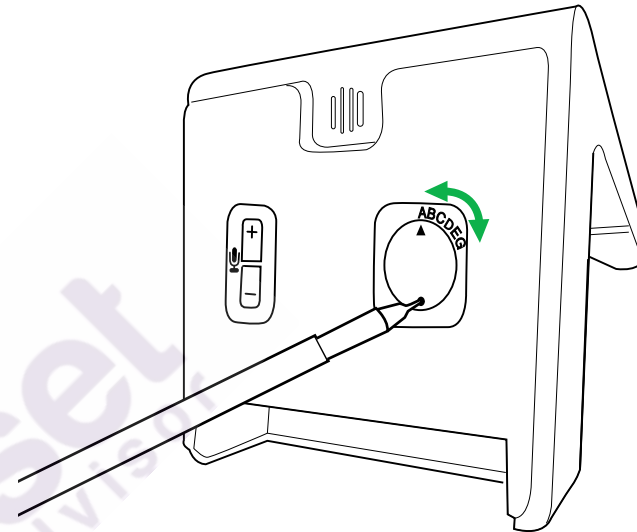

If you cannot hear a dial tone in your desk phone, it may be necessary to adjust the dial tone switch to a different setting.

The dial tone switch is located on the bottom of the base. Use a pointed object to rotate the switch between the different settings, until you do hear a dial tone in the headset. The default setting is A.

6.8 How to add a new primary headset

There are three methods for adding a new primary headset to the base:

A) If the current primary headset is not within range of the base or is turned off, simply dock the new headset in the base. It will become the primary headset. The conference and headset status LED on the base will flash to indicate the new headset is now the primary headset.

B) If the current primary headset is within range of the base and is turned on, and the base is not on a call, dock the new headset in the base and hold the **Call** button (1 sec) on the headset until the conference and headset status LED on the base flashes, indicating that it is now the primary headset.

C) If **Easy pairing** has been enabled in Jabra Direct, and the current primary headset is not on a call, simply dock the new headset in the base. It will become the primary headset. The conference and headset status LED on the base will flash to indicate the new headset is now the primary headset.

6.9 How to reset

Resetting the headset and the base resets all settings.

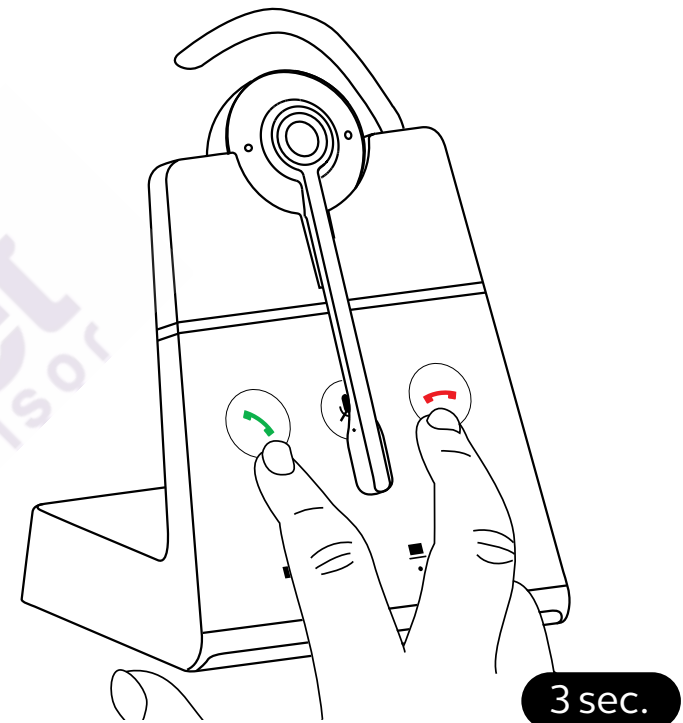





To reset:

1. Dock the headset in the base.
2. Simultaneously press and hold the **Answer call** button and the **End call** button on the base for 3 seconds. The headset and base will reboot and all settings will return to their default values.

The base and headset can also be reset using Jabra Direct.

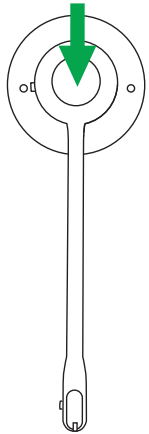
7. How to make calls

7.1 Basic call usage

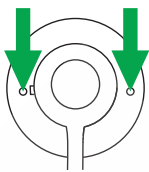
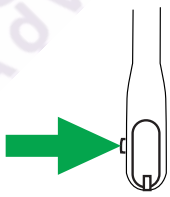
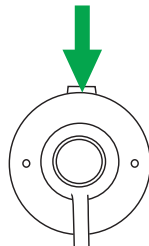

Function	Action
	<p>Power on</p> <p>Press the Call button on the headset, or undock the headset from the base</p>
	<p>Power off</p> <p>Hold the Call button for 4 seconds</p>
<p>Answer call</p>	<p>Press the Call button, undock the headset, or tap  on the base</p>
<p>End call</p>	<p>Press the Call button, dock the headset, or tap  on the base</p>
<p>Reject call</p>	<p>Double-press the Call button, or tap  on the base</p>
<p>Switch target phone</p>	<p>Undock the headset and hold the Call button for 1 second</p> <p>Alternatively, hold  on the base for 1 second</p>

<p>Adjust volume</p> 	<p>Press the Volume buttons.</p> <p>The convertible headset uses a motion sensor to detect which button is volume up and which is volume down, depending on the headset orientation</p>
<p>Toggle Busylight</p>	<p>Press both Volume buttons at the same time</p>
<p>Access the Voice-guided settings menu</p>	<p>Hold (3 secs) both Volume buttons at the same time</p>
<p>Mute/un-mute microphone</p> 	<p>Press the Mute button (stereo/mono headset)</p>
<p>Mute/un-mute microphone</p> 	<p>Press the Mute button (convertible headset)</p>

7.2 Merge calls

It is possible to merge an incoming call with a current call.

To merge calls:

1. Hold the **Call** button (2 secs) on the headset, or press  on the base to accept the incoming call. This will place the current call on hold.
2. Hold  (2 secs) to merge the calls.

To unmerge the calls, hold  (2 secs) on the base.

To end the merged call, dock the headset or press the **Call** button on the headset.

7.3 Conference calls

Add headset(s) to a conference call

Up to three additional headsets can be connected to one base for conferencing.

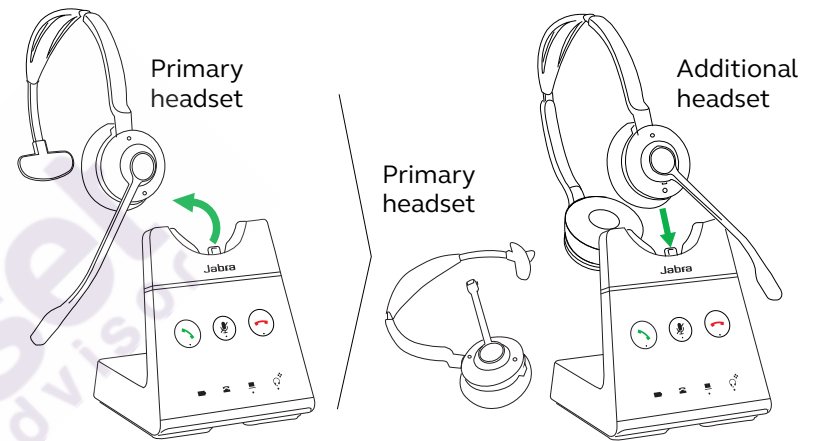

1. Undock the primary headset.
2. Dock an additional headset in the base. It will attempt to pair to the base.
3. A voice prompt will play in the primary headset. Press the **Call** button on the primary headset to accept the additional headset to the conference. The audio will now be shared between headsets.

By default, the additional headset will be muted.

Note: It is possible to use Jabra Engage 75 headsets for conference calls. See section **Add headset(s) to a conference call**.

Add headset(s) to a conference call without docking

Up to three additional headsets can be connected to one base, without the need to dock the headsets.

1. Undock the primary headset.
2. Power off the additional headset by holding the **Call** button for 4 seconds.
3. Hold  (3 secs) on the base. The conference LED on the base will flash.
4. Put the additional headset into pairing mode by holding the **Call** button for 5 seconds until the status LED on the headset flashes blue.
5. A voice prompt will play in the primary headset. Press the **Call** button on the primary headset to accept the additional headset to the conference. The audio will now be shared between headsets.

By default, the additional headset will be muted.

Note: It is possible to use Jabra Engage 75 headsets for conference calls.

End or leave a conference call

To end the call for all headsets, press the **Call** button on the primary headset, or dock the primary headset in the base.

Additional headsets can leave the conference by pressing the **Call** button on the headset, or by docking the additional headset in the primary headset's base (not the additional headset's base). The conference call will continue for all other headsets.

Permanent conference mode

By default, the conference will end automatically for all additional headsets when the call ends.

It is possible to continue the conference with the additional headsets until the primary headset is docked, by changing this setting in Jabra Direct.

7.4 Transfer a call from desk phone to headset

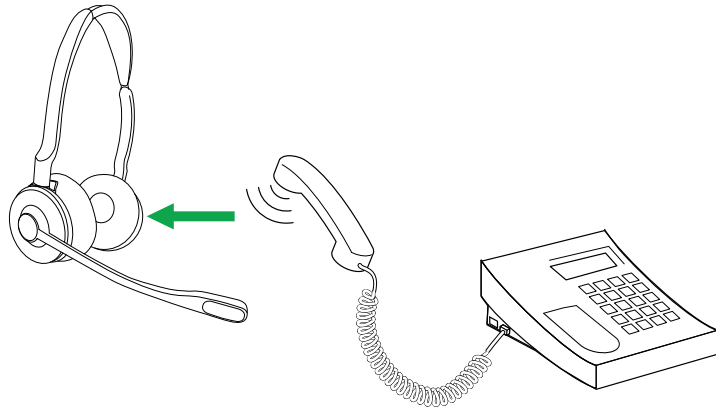

To transfer a call:

1. Select the desk phone as the target phone on the base.
2. Lift the headset from the base, or tap the **Call** button on the headset. The call audio will transfer from the desk phone handset to the headset. If necessary, press the headset button on the desk phone and do not hang up the handset until the call is finished.

7.5 Transfer a call from headset to desk phone

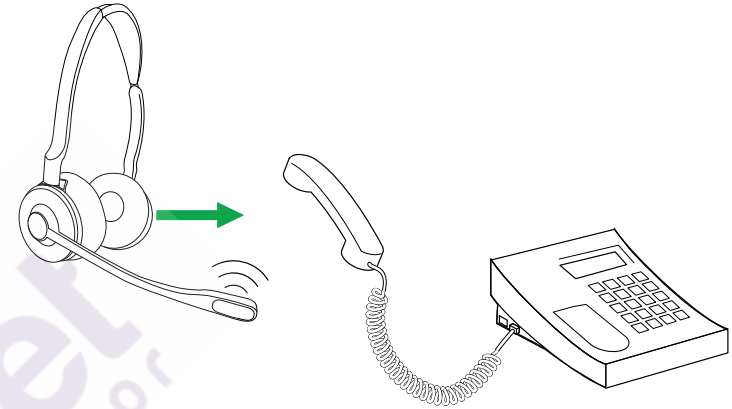

To transfer a call from the headset to a desk phone, lift the desk phone handset and then dock the headset in the base.

The call audio will transfer from the headset to the desk phone if the base is plugged into the handset port on the desk phone, otherwise press the headset button on the desk phone.

7.6 Multiple call handling

The headset and base can accept and handle multiple calls at the same time.

Multiple call handling

Answer incoming call and put current call on hold Tap  on the base

Switch between held call and active call Tap  on the base

Reject incoming call, while on a current call Tap  on the base

8. How to change settings

Headset and phone settings can be changed using the voice-guided settings menu.

Alternatively, all settings can be changed using Jabra Direct on your computer. Download Jabra Direct at jabra.com/direct.

Menu Navigation

Access the Voice-guided settings menu

Hold (3 secs) both the **Volume up** and the **Volume down** button at the same time

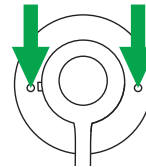

Cycle through setting options

Press the **Volume up** or the **Volume down** button

Exit the Voice-guided settings menu

Hold (2 secs) both the **Volume up** and the **Volume down** button at the same time

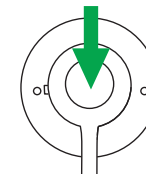

Accept setting option

Press the **Call** button to accept the announced setting option. You will cycle to the next setting

9. Jabra Direct

Jabra Direct is computer software designed to support, manage, and enable optimal functionality for your Jabra devices.

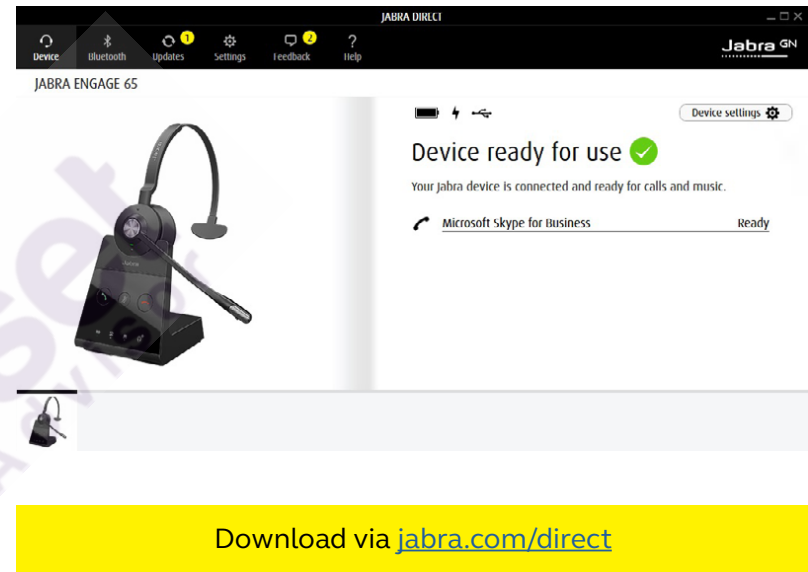

9.1 Firmware update

Jabra Direct will notify you when there is a firmware update available.

Settings

Voice prompt language	Select the headset voice language from a list of 5 languages
Voice prompts	Select to enable voice prompts
Mute reminder tone	Select to use a periodic audio reminder when the microphone is muted
Desk phone ringtone	Select a ringtone for desk phones
Desk phone ringtone volume	Select the ringtone volume for desk phones
Softphone ringtone	Select a ringtone for softphones
Softphone ringtone volume	Select the ringtone volume for softphones
Range or density	Select if the base should be optimized for improved range, or improved density
Hook lifter type	Select the hook lifter type
Default phone	Select which phone type is the default

10. Support

10.1 FAQ

View the FAQs at jabra.com/engage.

10.2 How to care for your device

- It is recommended to keep the headset between -5°C and 45°C (23°F and 113°F).
- Do not store the headset for extended periods of time without recharging the battery (max. three months).
- If the headset or base becomes dirty, it is recommended to clean them with a soft, lint-free cloth that has been dampened with clean water.

10.3 Replacement accessories

Replacement or additional accessories can be purchased online at jabra.com/accessories.