

Questions?
Click to Live Chat

Jabra Speak 750



User manual

UC-certified

GN Making Life Sound Better

Headset
Advisor

© 2020 GN Audio A/S. All rights reserved. Jabra® is a trademark of GN Audio A/S. The Bluetooth® word mark and logos are registered trademarks owned by the Bluetooth SIG, Inc. and any use of such marks by GN Audio A/S is under license.

Designed and engineered in Denmark

Made in China

MODEL: PHS040Wa / END040W



Declaration of Conformity can be found on
www.jabra.com/doc

1. Welcome.....	5	7. Software and firmware	23
2. Overview.....	6	7.1 Jabra Direct	
3. Where To Position	7	7.2 Update firmware	
3.1 Small-sized meeting room		8. Support	24
3.2 Medium-sized meeting room		8.1 FAQ and technical specifications	
3.3 Desk		8.2 How to care for your Jabra device	
3.4 Stereo media			
4. How To Charge.....	11		
4.1 USB charging			
4.2 Automatic power off			
4.3 Battery status			
5. How To Connect	13		
5.1 Connect to computer (Bluetooth adapter)			
5.2 Connect to computer (USB cable)			
5.3 Connect to smartphone			
6. How To Use	16		
6.1 Button visibility			
6.2 Typical use			
6.3 Multiple call handling			
6.4 Link button			
6.5 Smart button			
6.6 Voice guidance			
6.7 Shared use			
6.8 Factory reset			

1. Welcome

Thank you for using the Jabra Speak 750. We hope you will enjoy it!

Jabra Speak 750 features

- Immersive sound for calls and music
- Intuitive plug-and-play connectivity - connect to computer via USB or Bluetooth adapter, or connect to smartphone and tablet via Bluetooth
- Lightweight design, protective travel pouch, and up to 11 hours of battery life
- Dedicated Link button to pair two Jabra Speak 750 devices together for flexible and scalable meetings
- Interact with your voice assistant with the one touch Smart button
- Certified with all leading Unified Communications (UC) platforms

2. Overview

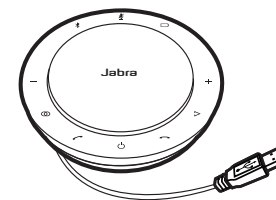
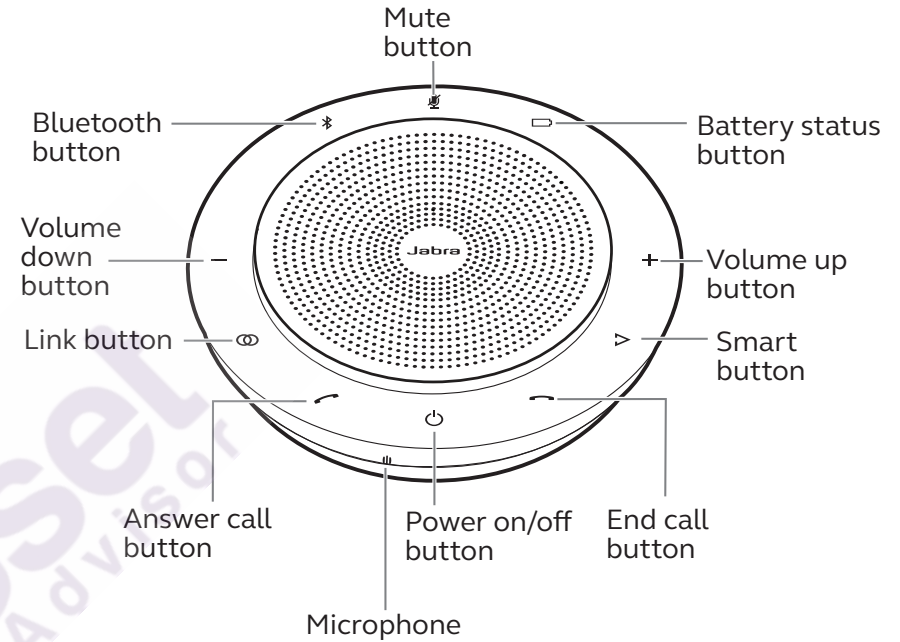

USB cable

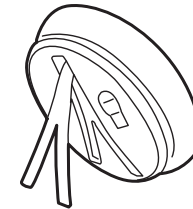
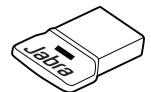

Table stand and Bluetooth adapter storage



Jabra Link 370 Bluetooth adapter



Pouch

3. Where to position

3.1 Small-sized meeting room

For the optimal audio quality, position the speakerphone in the center of the table, up to 2.3m/7.5ft from each participant, but no closer than 0.5m/1.6ft. A single Jabra Speak 750 is ideal for up to 6 people.

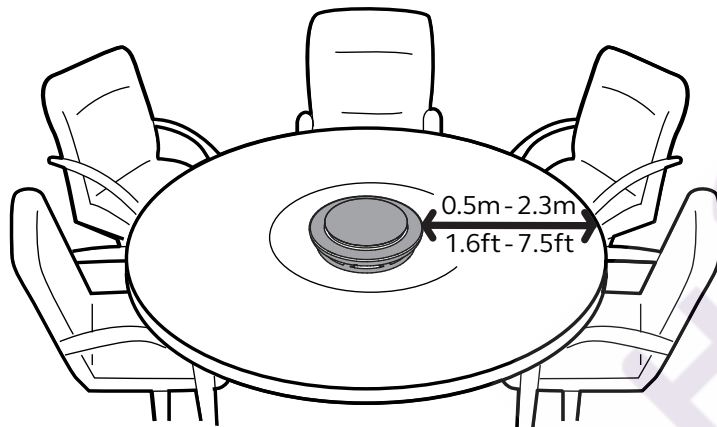

3.2 Medium-sized meeting room

For large meetings of up to 12 people in a single room, position two Jabra Speak 750 devices up to 4m/13ft apart, but no closer than 0.5m/1.6ft. Positioning them at either end of the table, between 0.5m/1.6ft to 2.3m/7.5 ft from participants, will ensure optimal audio quality.

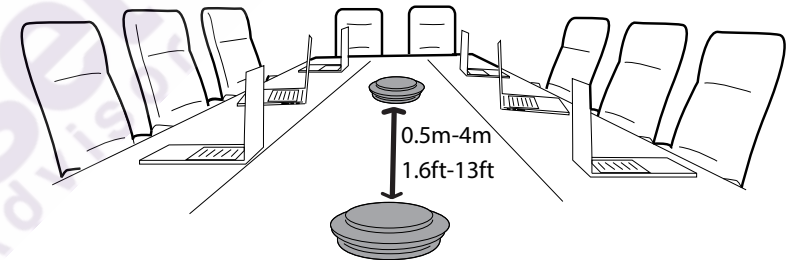

To temporarily link the audio between two Jabra Speak 750 devices, tap the **Link** button on both speakerphones when they are within 4m/13ft.

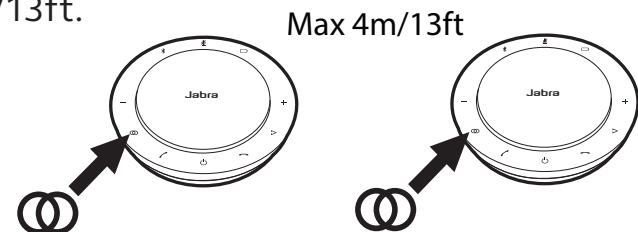

3.3 Desk

When using the Jabra Speak 750 at your desk it is recommended to put the speakerphone into an upright position using the table stand. This will better direct the audio towards you for a richer music and media experience. Additionally, two Jabra Speak 750 devices can be linked together for stereo sound.

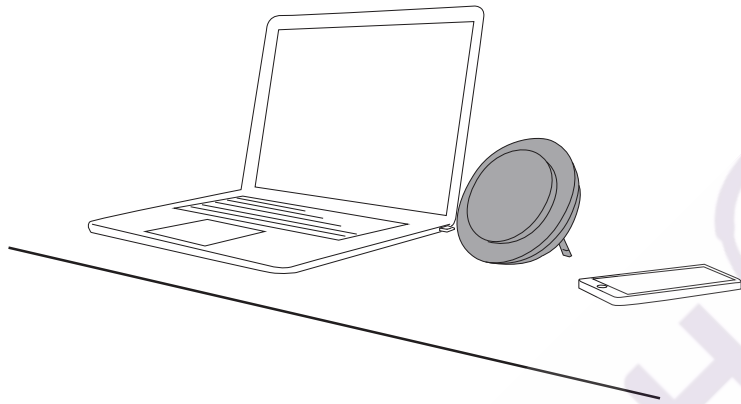

3.4 Stereo media

If you are displaying or viewing stereo media in a meeting or listening to music or media at your desk, two Jabra Speak 750 devices can be positioned on either side of a projector or monitor for stereo sound.

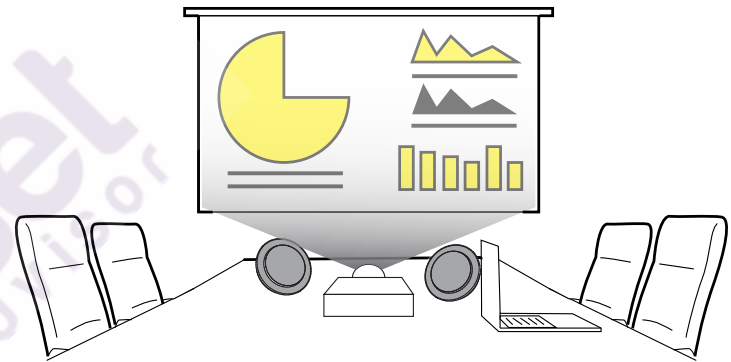

To temporarily link the audio between two Jabra Speak 750 devices, tap the **Link** button on both speakerphones when they are within 4m/13ft.

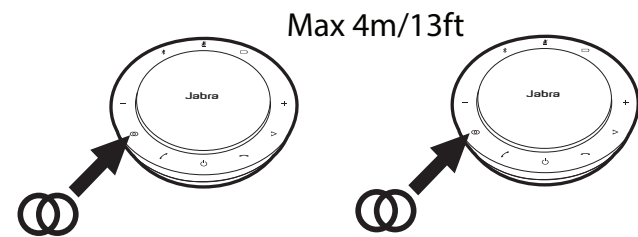

4. How to charge

4.1 USB charging

Plug the Jabra Speak 750 into a USB power source using the attached USB cable. The Jabra Speak 750 battery lasts for up to 11 hours of talk time and takes approx. 3 hours to fully charge.

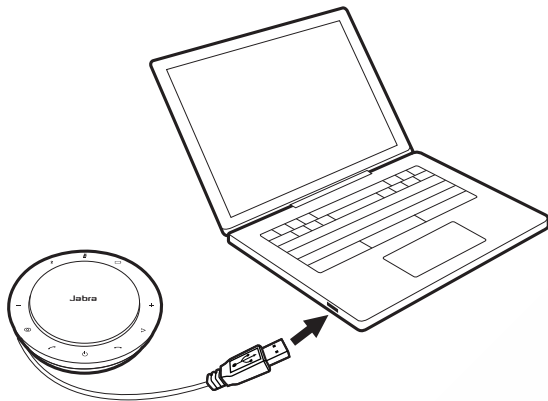

4.2 Automatic power off

To preserve battery while unplugged, the Jabra Speak 750 will automatically power off when it has not been connected to a Bluetooth device for 15 minutes.

If connected to a Bluetooth device and not plugged into power, the Jabra Speak 750 will automatically power off after 8 hours.

4.3 Battery status

To view the current battery status, tap the **Battery status** button. The LEDs around the edge of the Jabra Speak 750 will light up to indicate the current battery status.

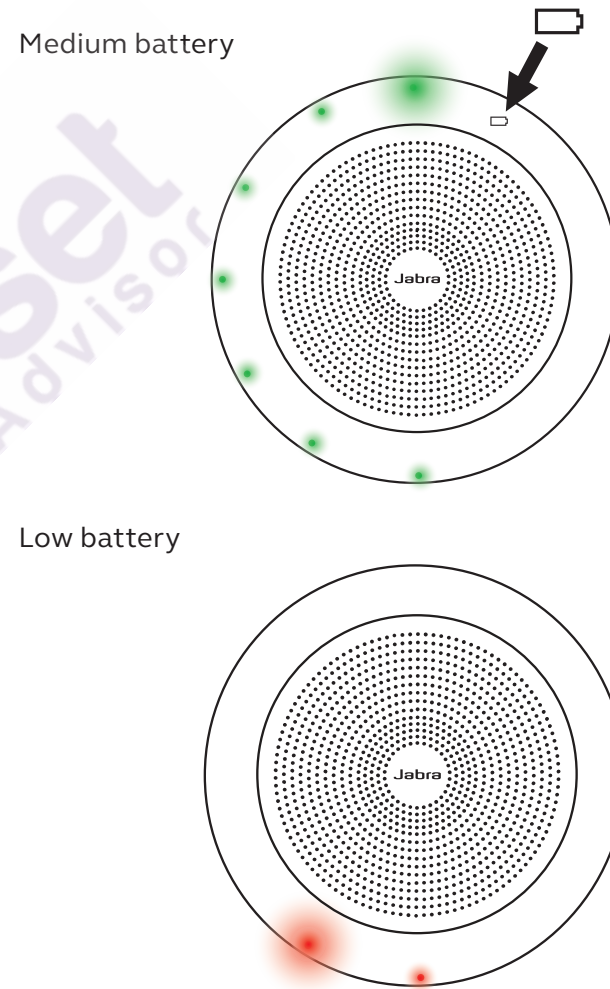

5. How to connect

5.1 Connect to computer (Bluetooth adapter)

Plug the Jabra Link 370 Bluetooth adapter into a USB port on your computer. The Jabra Speak 750 and the Jabra Link 370 Bluetooth adapter are pre-paired and ready to use out of the box. The Bluetooth range is up to 30m/98ft. Before first time use, plug the USB cable into your computer to wake the speakerphone.

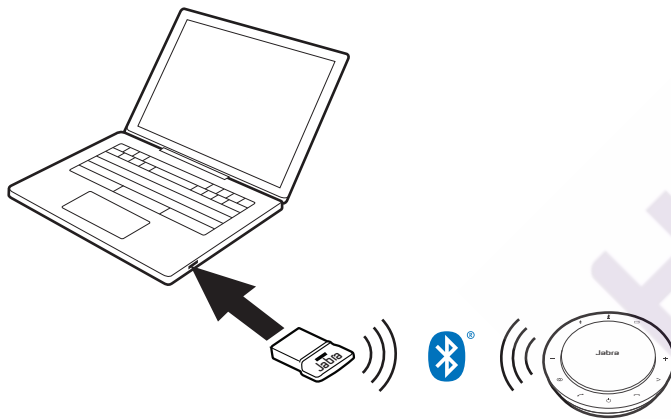

For the Jabra Speak 750 to work correctly, you may need to set the Jabra Link 370 Bluetooth adapter as the playback and recording device in your operating system's audio settings.

If you need to re-pair the Jabra Speak 750 with the Jabra Link 370 Bluetooth adapter, please use Jabra Direct. Jabra Direct can be downloaded at jabra.com/direct.

5.2 Connect to computer (USB cable)

Plug the Jabra Speak 750 into a USB port on your computer. Before first time use, plug the USB cable into your computer to wake the speakerphone.

You may need to set the Jabra Speak 750 as the playback and recording device in your operating system's audio settings.

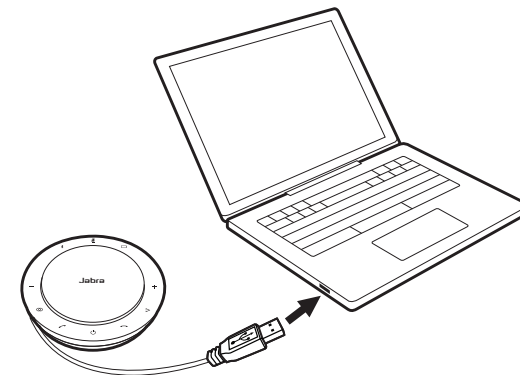

5.3 Connect to smartphone or tablet

Hold the **Bluetooth** button for 2 seconds and follow the voice-guided instructions to pair to your smartphone or tablet. The Bluetooth range is up to 10m/33ft. Before first time use, plug the USB cable into your computer to wake the speakerphone.



To disconnect or reconnect, tap the **Bluetooth** button again.

6. How to use

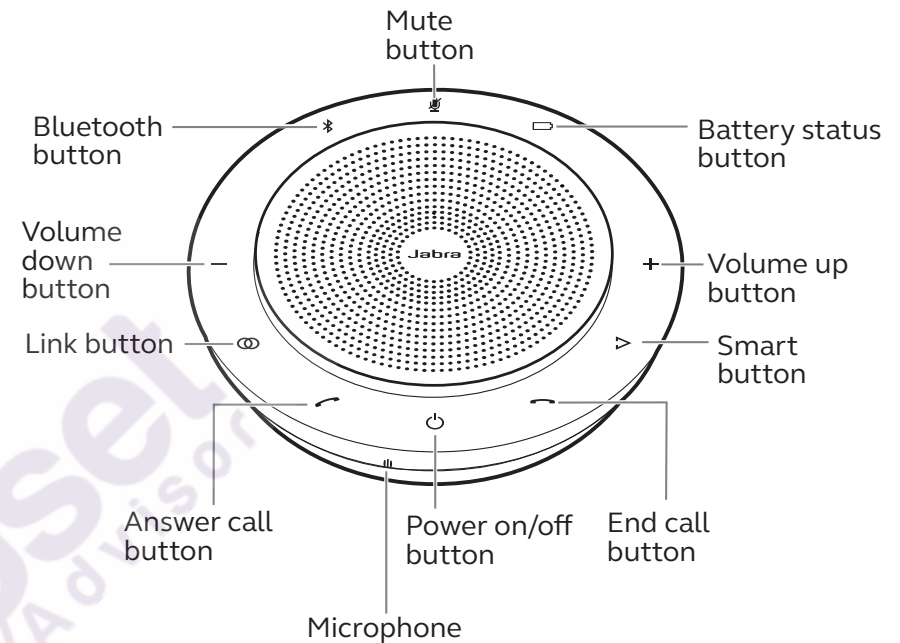









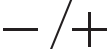

6.1 Button visibility

The buttons are backlit and only visible when the speakerphone is powered on. After 1 minute of inactivity the buttons will fade, and can be reactivated by tapping the area where the buttons are located.



The **Smart** button, **Link** button and **Mute** button will only be visible under certain conditions (see sections 6.4 and 6.5 for details).

6.2 Typical use

WHAT	HOW
 Power on or off	Hold (1 sec) the Power button
 Answer call	Tap the Answer call button
 End or reject call	Tap the End call button
 Turn on/off voice guidance	Hold (8 secs) the End call button
 Volume down/up	Tap (or hold) the Volume down or Volume up button
 Mute/unmute microphone	Tap the Mute button (only visible when on a call)
 Battery status	Tap the Battery status button
 Connect Bluetooth device	Tap the Bluetooth status button

WHAT	HOW
 Link two Jabra Speak 750 devices	Tap the Link button (only visible when within 4m/13ft range of another Jabra Speak 750)
 Voice assistant (smartphones)	Tap the Smart button (only visible when connected to a smartphone)
 Speed dial (off by default)	Tap the Smart button (use Jabra Direct to enable speed dial)

6.3 Multiple call handling

WHAT	HOW
 Put current call on hold and answer incoming call	Tap the Answer call button
 Switch between held call and active call	Tap the Answer call button
 Reject incoming call, and continue current call	Tap the End call button

6.4 Link button

To temporarily link the audio between two Jabra Speak 750 devices, tap the **Link** button on both speakerphones when they are within 4m/13ft. The **Link** button will only be visible when two Jabra Speak 750 devices are within 4m/13ft.

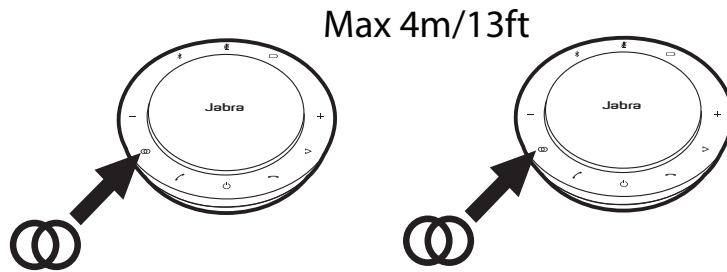

To unlink the speakerphones, tap the **Link** button on one of the speakerphones.

NOTE: Linking two Jabra 750 devices uses a Bluetooth connection. Each Speak 750 can only have two active Bluetooth connections. If two Bluetooth devices are currently connected to one of the Jabra Speak 750 devices, the last connected Bluetooth device will temporarily be replaced by the Jabra 750 link. When the Jabra 750 devices are unlinked, the Bluetooth device connection that was temporarily replaced, will be restored.

6.5 Smart button

By default, the Smart button will activate your smartphone's voice assistant (Siri®, Google Assistant™, Cortana™) when you are connected to a smartphone.

However, if you would prefer the Smart button to speed dial a phone number on your Smartphone or PC, this can be configured using Jabra Direct.

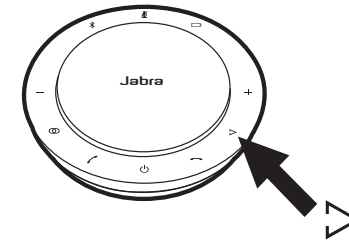

6.6 Voice guidance

The voice guidance can be turned on or off by holding the **End call** button for 8 seconds.

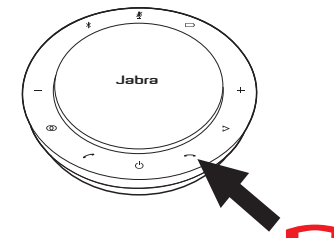

6.7 Shared use

If the Jabra Speak 750 is to be shared by many people using Bluetooth, it is recommended to enable Shared use, which can be configured in Jabra Direct. When Shared use is enabled, the speakerphone will **not** automatically connect to a previously connected Smartphone or Jabra Link 370 Bluetooth adapter. Instead, the Bluetooth devices will need to be paired with the speakerphone each and every time the smartphone is out of range, or turned off and on.

To pair a smartphone or Jabra Link 370 Bluetooth adapter to the speakerphone, hold (2 sec) the **Bluetooth** button on the speakerphone and follow the voice-guided instructions.

6.8 Factory reset

Resetting the Jabra Speak 750 clears the list of paired Bluetooth devices and also clears all personalized settings. After a factory reset, it is necessary to re-pair the Jabra Speak 750 to your Bluetooth devices and Jabra Link 370 Bluetooth adapter.

To factory reset, hold the **Answer call** button and the **End call** button for 8 seconds until 'Factory reset' is announced by the speakerphone.

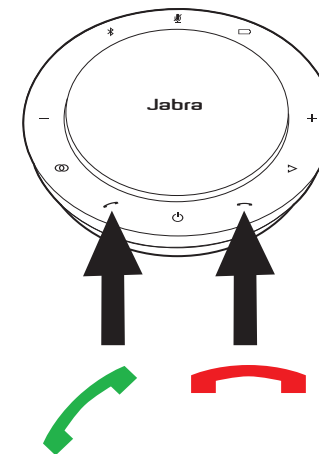

7. Software and firmware

7.1 Jabra Direct

Jabra Direct is computer software designed to support, manage and enable optimal functionality for Jabra devices.

Download the latest free version from jabra.com/direct

7.2 Update firmware

Firmware updates improve performance or add new functionality to Jabra devices.

1. Connect the Jabra Speak 750 to a computer using the USB cable or Jabra Link 370 Bluetooth adapter.
2. Use Jabra Direct to check for the latest firmware updates. Jabra Direct can be downloaded from jabra.com/direct

8. Support

8.1 FAQ and technical specifications

View the FAQ, certifications, and technical specifications at jabra.com/help/speak750

8.2 How to care for your Jabra device

- The Jabra Speak 750 is for indoor use only.
- Avoid storage at extreme temperatures (above 40°C/113°F or below -40°C/-40°F).
- Do not expose the Jabra Speak 750 to rain or other liquids.
- Do not cover the Jabra Speak 750 speaker mesh and buttons with stickers or labels.