

NEED MORE HELP?

**Questions?**  
**Click to Live Chat**

For all support go to [jabra.com/support](https://jabra.com/support)



Questions?  
Click to Live Chat

Jabra

# PRO 930 Duo



Quick start guide

**Questions?  
Click to Live Chat**

Headset  
Advisor

---

© 2015 GN Audio A/S (GN Netcom A/S). All rights reserved. Jabra® is a trademark of GN Audio A/S.

---

MADE IN CHINA  
MODEL: WHB003BS/ WHB003HS



---

[www.jabra.com](http://www.jabra.com)

**Questions?**  
**Click to Live Chat**

**Headset**  
Advisor

**Questions?  
Click to Live Chat**

## LANGUAGES

ENGLISH / EN	2
FRANÇAIS / FR	6
DEUTSCH / DE	10
ESPAÑOL / ES	14
繁體中文 / CHT	18

## PACKAGE CONTENTS

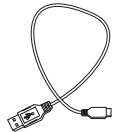
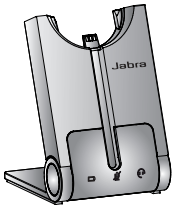

# JABRA PRO 930 DUO HEADSET

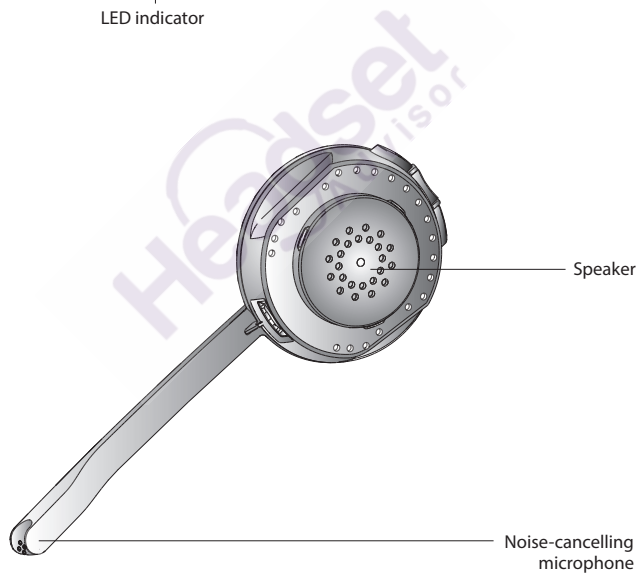
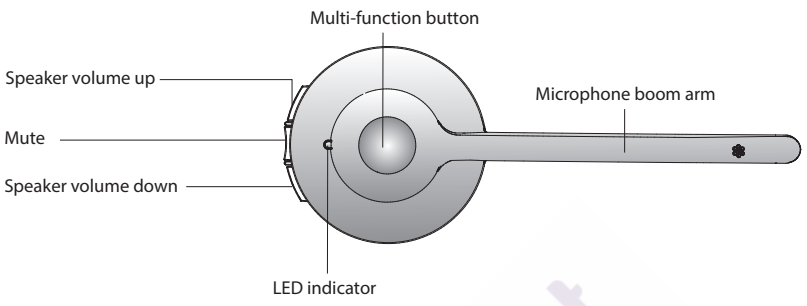

# JABRA PRO 930 DUO BASE

EN

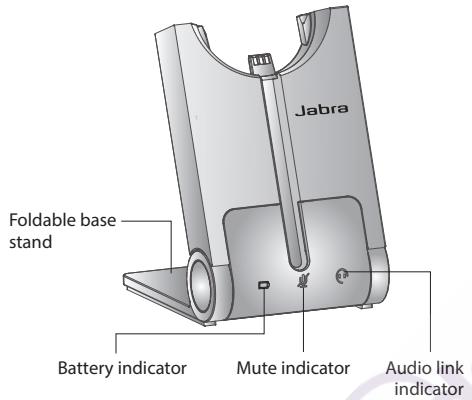

Icon	Event
	Battery charging (slow flash)
	Full battery
	Medium battery
	Low battery
	Very low battery (fast flash)
	Sleep mode (slow flash)
	Unknown battery status
	Microphone muted
	Active audio link between headset and base
	Searching for headset

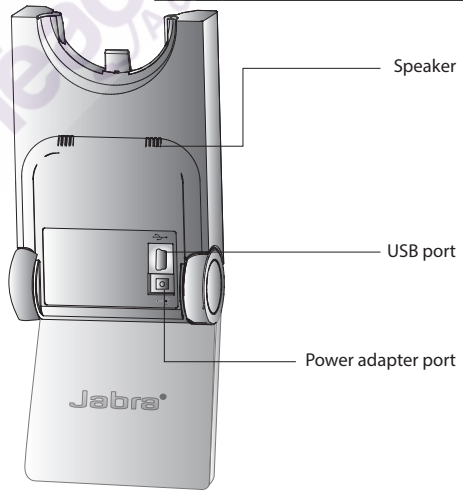
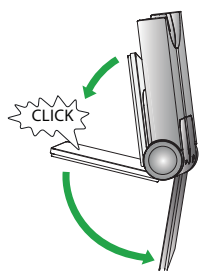

### STEP 1: CONNECT TO PC

1. Plug the supplied USB cable into the port marked  on the base.
2. Connect the USB cable to any free USB slot on the PC.
3. Install Jabra Direct software from [www.jabra.com/direct](http://www.jabra.com/direct)

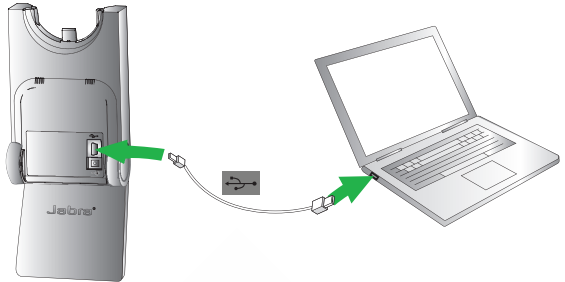

### STEP 2: CONNECT TO POWER

1. Plug the supplied power adapter into the port marked  on the base.
2. Connect the power adapter to the mains power socket.

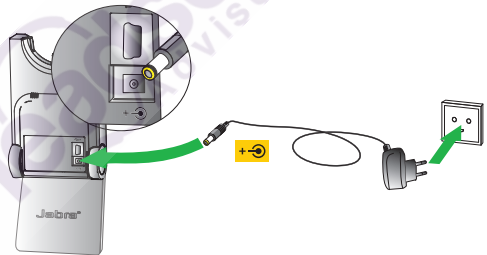



### STEP 3: DOCK THE HEADSET

Dock the headset. When docked correctly the headset battery will begin charging, if needed.

Charge for 20 minutes or until the battery indicator on the base  is steady green.

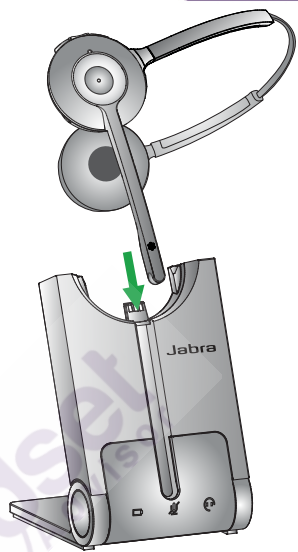

#### **IMPORTANT**

Set the Jabra PRO 930 Duo as speaker and microphone in the softphone audio settings.

**YOU HAVE NOW SUCCESSFULLY CONNECTED YOUR JABRA PRO 930 DUO**

### DID YOU KNOW?

The Jabra PRO 930 Duo has advanced settings that you can quickly and easily configure yourself. Refer to the User Manual to learn how.

# MICRO-CASQUE JABRA PRO 930 DUO

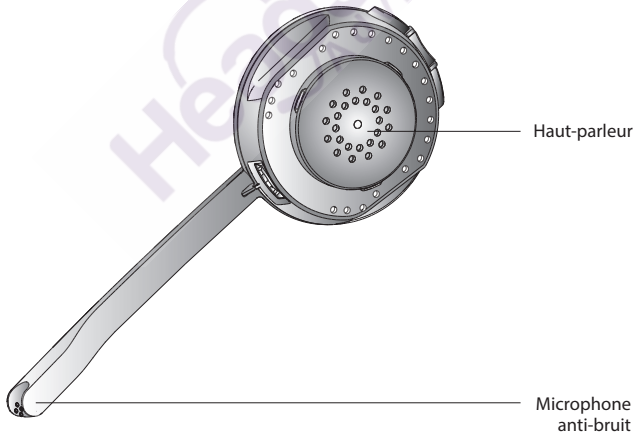
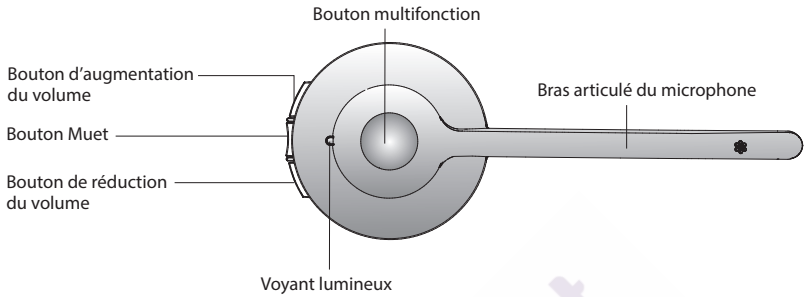

# BASE DU JABRA PRO 930 DUO

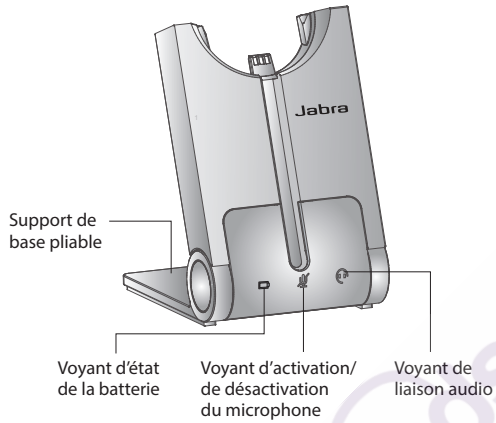

Icône	Événement
	Batterie en charge (clignotement lent)
	Batterie chargée
	Batterie moyennement chargée
	Batterie faible
	Batterie très faible (clignotement rapide)
	Mode veille (clignotement lent)
	État de la batterie inconnu
	Microphone désactivé
	Liaison audio active entre le micro-casque et la base
	Recherche du micro-casque en cours

FR

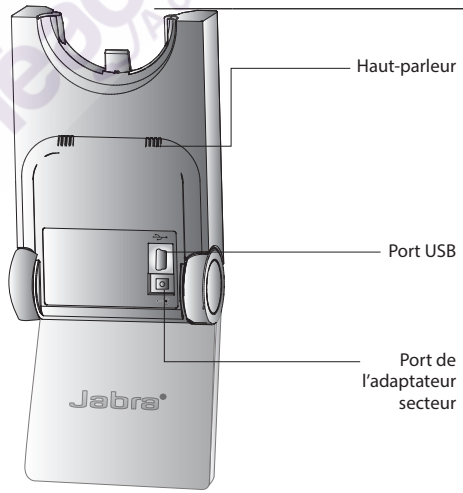
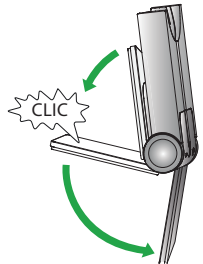

### ÉTAPE 1: RACCORDEMENT AU PC

1. Branchez le câble USB fourni sur le port repéré  sur la base.
2. Branchez le câble USB sur un port USB libre du PC.
3. Installez le logiciel Jabra Direct à partir du site web [www.jabra.com/direct](http://www.jabra.com/direct)

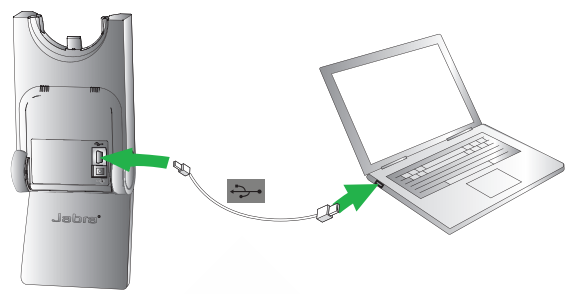

### ÉTAPE 2: RACCORDEMENT AU SECTEUR

1. Branchez l'adaptateur électrique fourni sur le port repéré  de la base.
2. Branchez l'adaptateur électrique sur la prise secteur.

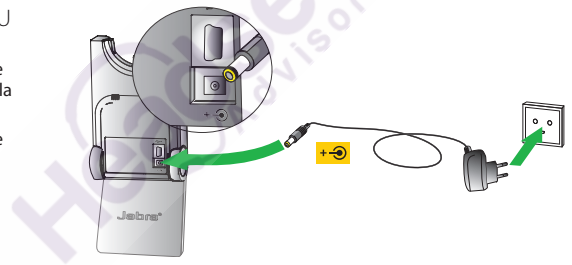

### ÉTAPE 3: INSERTION DU MICRO-CASQUE DANS LE SUPPORT

Insérez le micro-casque dans son support. Une fois le micro-casque correctement inséré, la batterie commence à se charger, si nécessaire.

Chargez pendant 20 minutes ou jusqu'à ce que le voyant d'état de la batterie de la base  soit vert fixe.

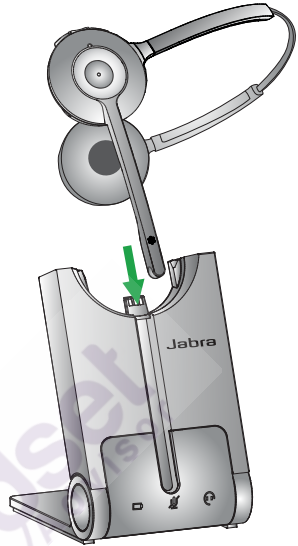

FR

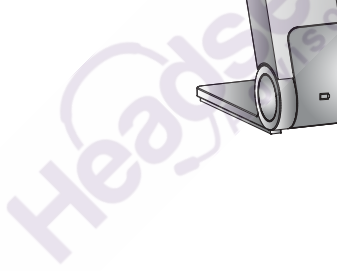

#### **IMPORTANT**

Définissez le Jabra PRO 930 Duo en tant que haut-parleur et microphone dans les paramètres audio du logiciel de téléphonie.

**VOUS AVEZ MAINTENANT CORRECTEMENT CONNECTÉ VOTRE JABRA PRO 930 DUO**

### LE SAVIEZ-VOUS ?

Le Jabra PRO 930 Duo est doté de paramètres avancés que vous pouvez configurer vous-même rapidement et facilement. Référez-vous au Manuel d'utilisation pour connaître la marche à suivre.

# JABRA PRO 930 DUO HEADSETS

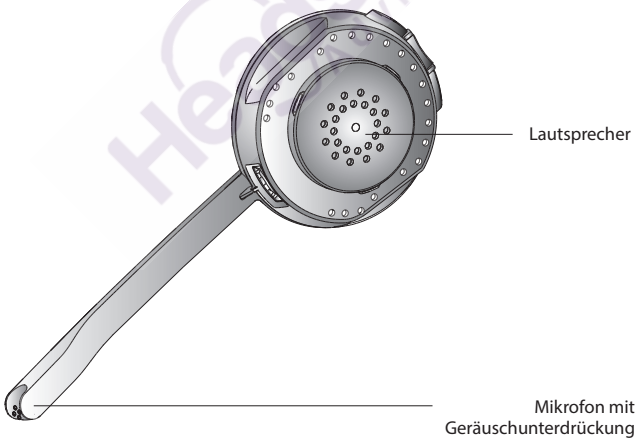
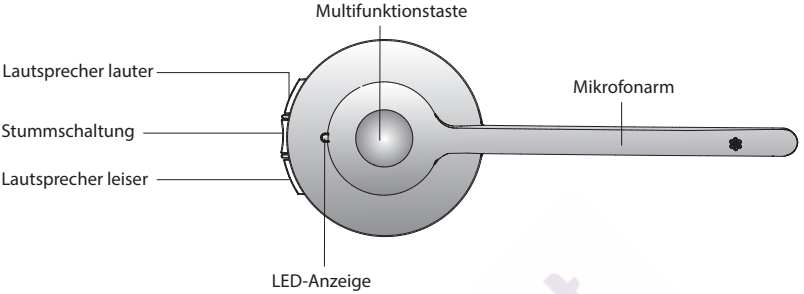

# JABRA PRO 930 DUO BASISSTATION

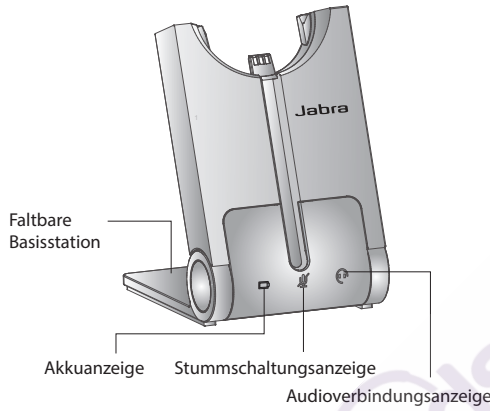

Symbol	Ereignis
	Akku wird geladen (blinkt langsam)
	Akku voll
	Mittlerer Akkuladestand
	Akkuladestand niedrig
	Akkuladestand sehr niedrig (blinkt schnell)
	Ruhemodus (blinkt langsam)
	Akkuladestand unbekannt
	Mikrofon stummgeschaltet
	Audioverbindung zwischen Headset und Basisstation aktiv
	Suche nach Headset durchführen

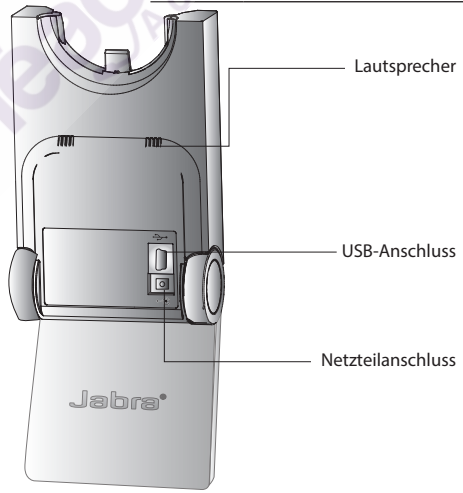
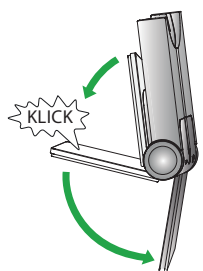

## SCHRITT 1: ANSCHLUSS AN EINEN COMPUTER

1. Stecken Sie das mitgelieferte USB-Kabel in den mit dem Symbol  markierten Anschluss an der Basisstation
2. Verbinden Sie das USB-Kabel mit einem freien USB-Anschluss am Computer
3. Navigieren Sie zu [www.jabra.com/direct](http://www.jabra.com/direct) und installieren Sie die Jabra Direct-Software.

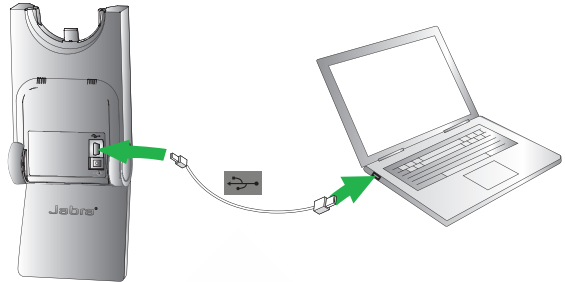

## SCHRITT 2: ANSCHLUSS AN DIE NETZSTROMVERSORGUNG

1. Stecken Sie das mitgelieferte Netzteil in die mit dem Symbol  markierte Stromversorgungsbuchse an der Basisstation.
2. Schließen Sie das Netzteil an eine Steckdose an.

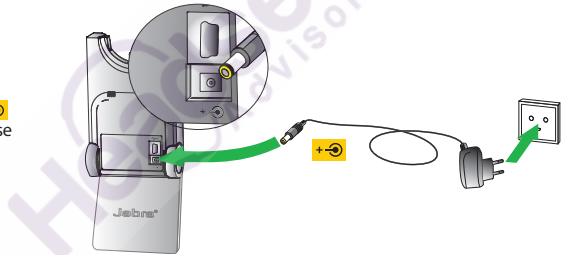



### SCHRITT 3: ANDOCKEN DES HEADSETS

Führen Sie das Headset in den Ladeschacht ein. Ist das Headset korrekt angedockt, wird der Akku nach Bedarf geladen.

Laden Sie das Headset 20 Minuten lang bzw. bis die Akkuanzeige  an der Basisstation dauerhaft grün leuchtet.

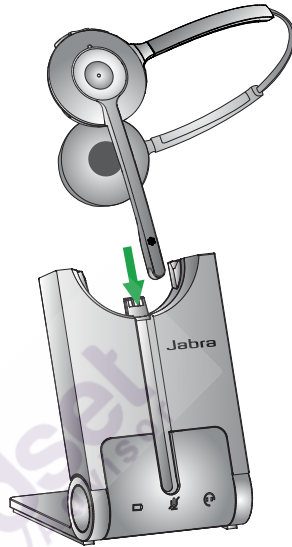

DE

#### **WICHTIG**

Legen Sie in den Einstellungen der Softphone-Anwendung das Jabra PRO 930 Duo als Lautsprecher und als Mikrofon fest.

**IHR JABRA PRO 930 DUO IST JETZT ANGESCHLOSSEN**

### HÄTTEN SIE ES GEWUSST?

Das Jabra PRO 930 Duo verfügt über fortschrittliche Einstellungen, mit denen Sie Ihr Telefon schnell und mühelos konfigurieren können. Wie dies geht, erfahren Sie im Benutzerhandbuch.

# AURICULAR JABRA PRO 930 DUO

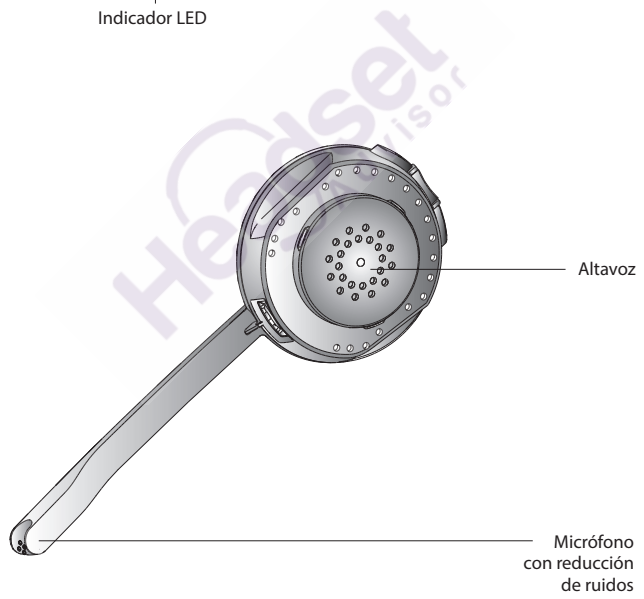
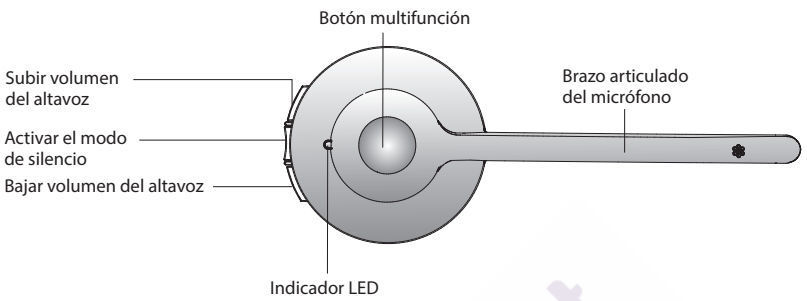

# BASE JABRA PRO 930 DUO

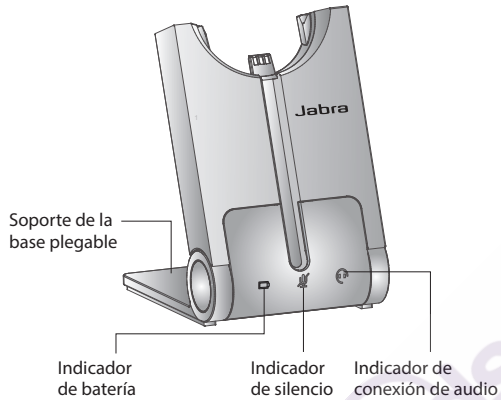

Icono	Evento
	Batería cargándose (parpadeo lento)
	Batería con carga completa
	Batería con carga intermedia
	Batería baja
	Batería muy baja (parpadeo rápido)
	Modo de inactividad (parpadeo lento)
	Estado de batería desconocido
	Micrófono en silencio
	Conexión de audio activa entre el auricular y la base
	Búsqueda del auricular

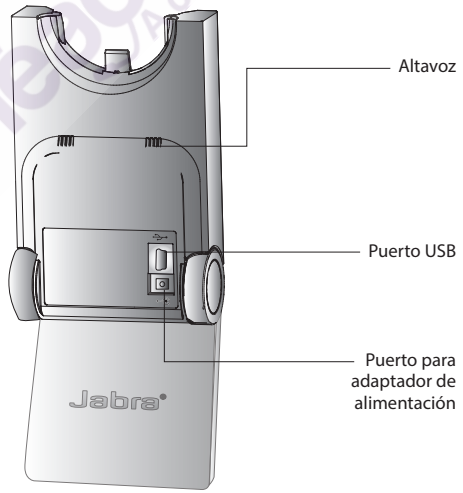
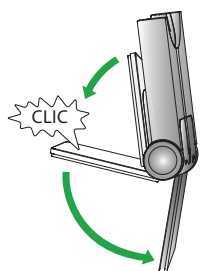

### SPASO 1: CONEXIÓN AL PC

1. Conecte el cable USB suministrado en el puerto de la base marcado con el símbolo .
2. Conecte el cable USB a cualquier puerto USB libre del PC.
3. Instale el software Jabra Direct desde [www.jabra.com/direct](http://www.jabra.com/direct)

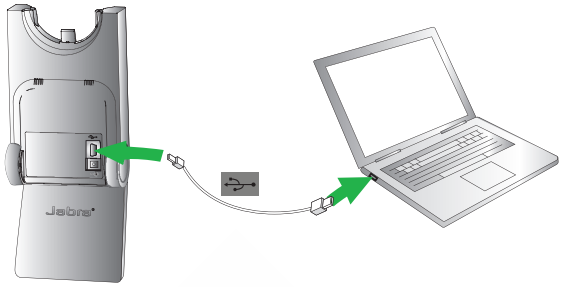

### PASO 2: CONEXIÓN A LA RED ELÉCTRICA

1. Enchufe el adaptador de alimentación suministrado al puerto de la base con la marca .
2. Conecte el adaptador de alimentación al enchufe de la red eléctrica.

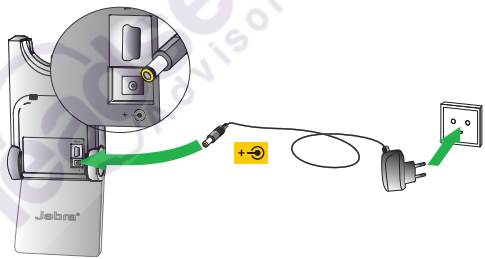

### PASO 3: ACOPLAMIENTO DEL AURICULAR

Acople el auricular en la base. cuando esté correctamente acoplado, la batería del auricular se empezará a cargar si es necesario.

Cargue durante 20 minutos o hasta que el indicador de batería de la base  muestre una luz verde fija.

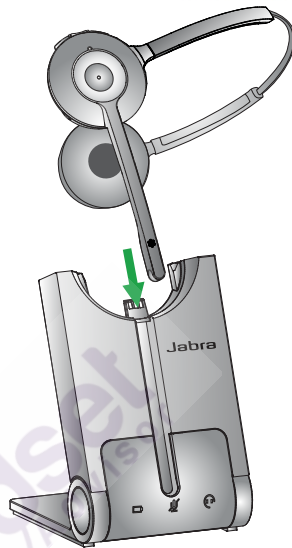

#### **IMPORTANTE**

Configure el Jabra PRO 930 Duo como altavoz y micrófono en la configuración de audio del softphone.

**YA HA CONECTADO CON ÉXITO SU JABRA PRO 930 DUO**

### ¿LO SABÍA?

Jabra PRO 930 Duo cuenta con ajustes avanzados que puede configurar rápida y fácilmente. Consulte el manual de usuario para más información.

# JABRA PRO 930 DUO 耳機

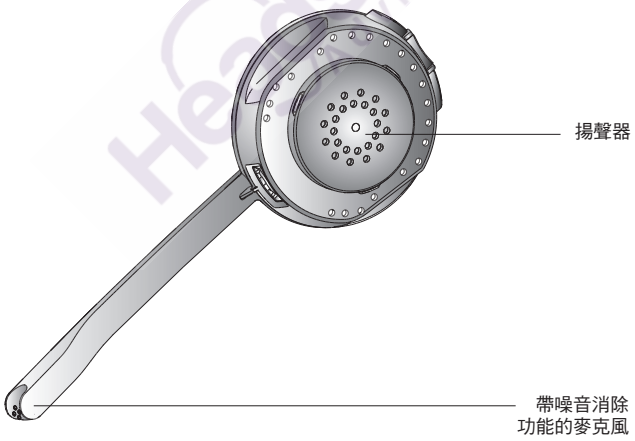
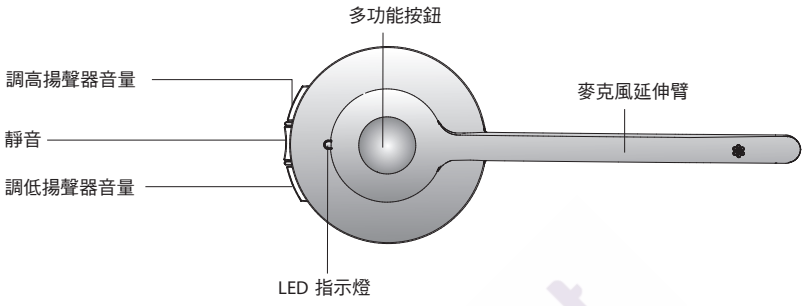

# JABRA PRO 930 DUO 底座

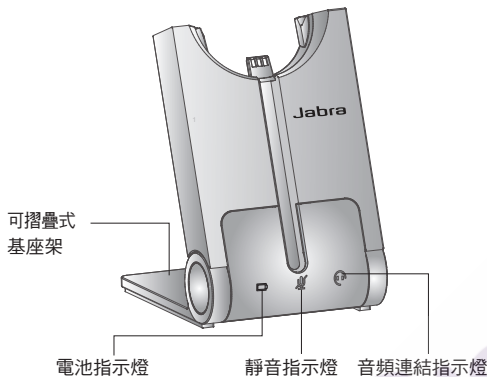

圖示	事件
	電池正在充電 (慢速閃爍)
	完全充電
	電量中等
	電力不足
	電量極低 (快速閃爍)
	睡眠模式 (慢速閃爍)
	不明的電池狀態
	麥克風已靜音
	耳機與底座之間存在音頻連結
	正在搜尋耳機

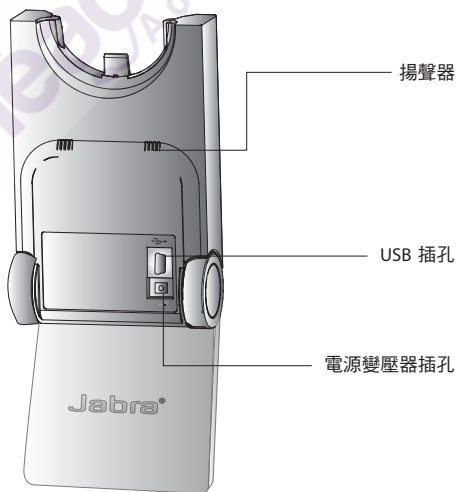
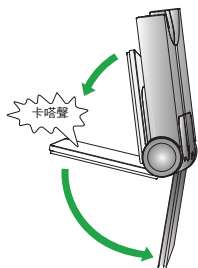

### 步驟 1：連接至個人電腦

1. 將隨附的 USB 纜線插入基座上標示為  的插孔。
2. 連接 USB 纜線到電腦上的任何可用 USB 插孔。
3. 從 [www.jabra.com/direct](http://www.jabra.com/direct) 上安裝 Jabra Direct 軟體

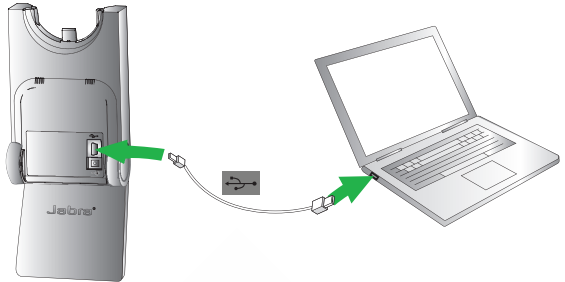

### 步驟 2：連接電源

1. 將隨附的電源變壓器插入基座上標示為  的插孔。
2. 將電源變壓器連接至主電源插座。

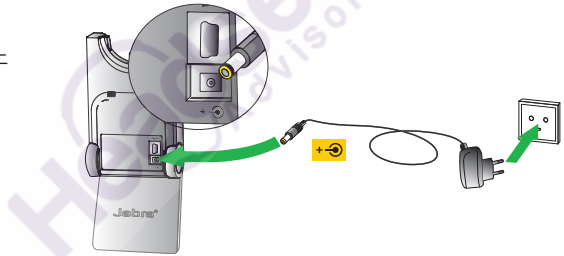



### 步驟 3：把耳機放在基座上

摺疊方式：敞開、閉合及直立位置。

把耳機放在基座上。當耳機妥當放在耳機座上後，耳機電池將會開始進行充電（如有需要）。

充電 20 分鐘或是等至基座上的電池指示燈  一直亮綠燈。

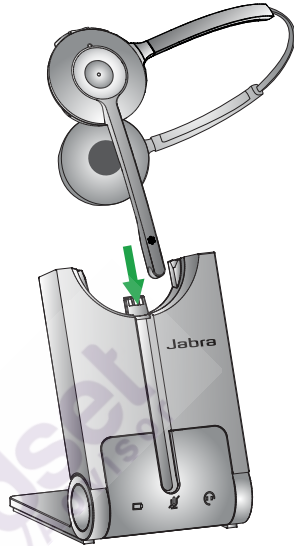

#### 重要事項

於軟體式電話的音頻設定中將 Jabra PRO 930 Duo 設定為揚聲器及麥克風。

現在您即完成連接 JABRA PRO 930 DUO

### 您知道嗎？

Jabra PRO 930 Duo 具有進階設定，您自己可以快速便捷的配置。請參閱使用者手冊以瞭解詳情。