



Beta



2017

AUTOPROMOTEC

Valida dal 24/5/2017 al 31/12/2017. Prezzi netti I.V.A. esclusa

C33 La nuova cassettera Beta

Cassettera mobile con 7 cassetti

- Sette cassetti da 588x367 mm, montati su guide telescopiche a sfera.
- Piano dei cassetti protetto da tappetini di gomma espansa.
- Quattro ruote Ø 125 mm: 2 fisse e 2 girevoli (una con freno).
- Serratura di sicurezza centralizzata frontale.
- Portaflaconi e portacarta laterali integrati regolabili in più posizioni.



1000 kg



1010 mm
490 mm
800 mm

71 kg

n°	h	max
5	75 mm	30 kg
1	150 mm	35 kg
1	225 mm	35 kg

033000271 033000272
C33 033000273
~~€ 890,00~~
€ 515,00



Più alta, più robusta, più sicura!



Portaminuterie e fori per l'alloggiamento dei giravite

Piano di lavoro multifunzione ad alta resistenza



Pratica scanalatura a "V" per la lavorazione di tubi o profilati

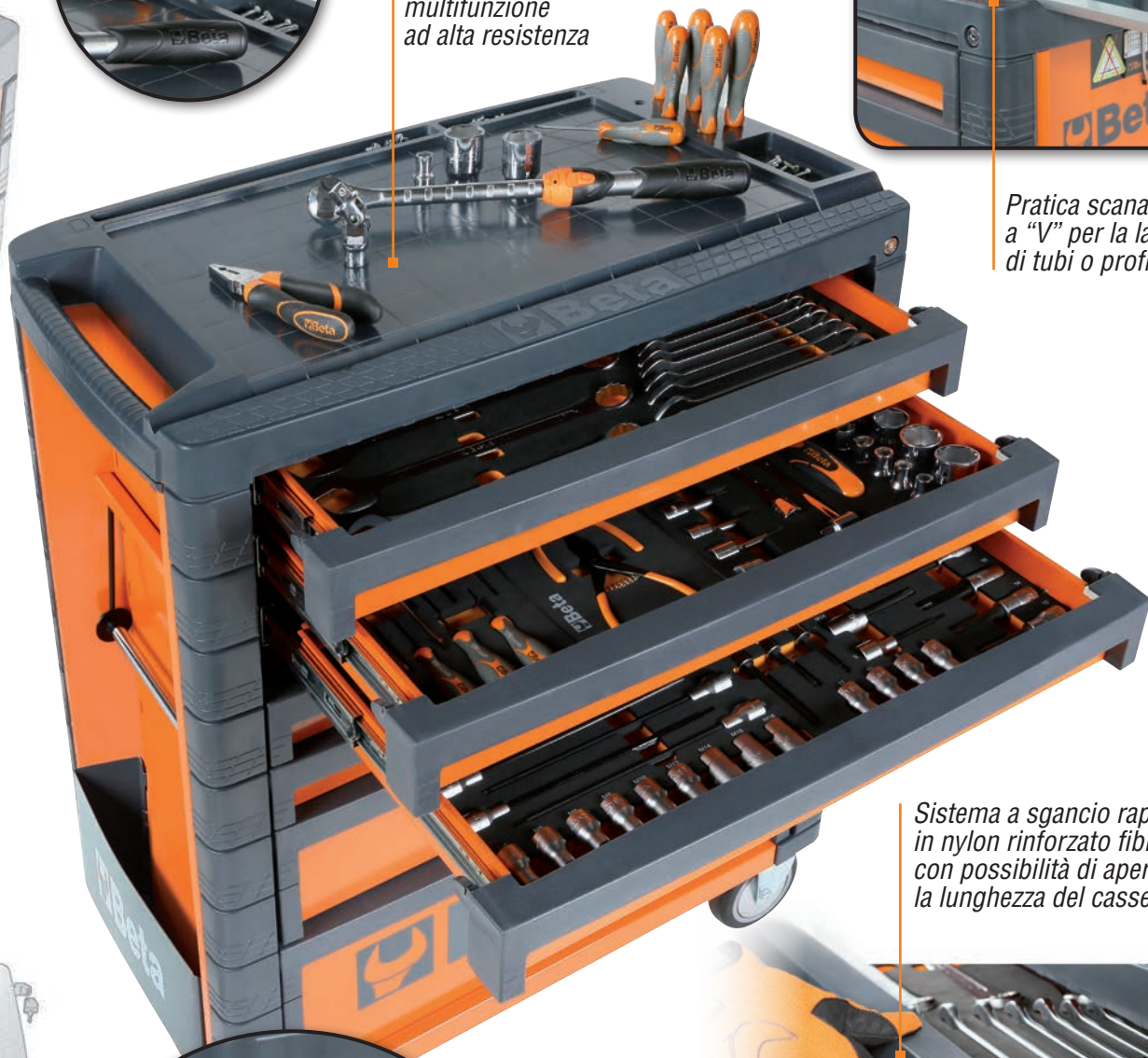

Sistema a sgancio rapido in nylon rinforzato fibra di vetro con possibilità di apertura su tutta la lunghezza del cassetto.



Paracolpi angolari

Paracolpi angolari su tutta l'altezza della cassetteria per evitare, in caso di urto, il danneggiamento dei veicoli all'interno dell'officina.



055000025

C55PB-PRO/5

Postazione di lavoro per arredo officina
Composta da:

C55B-PRO

Banco con piano da lavoro 2050x700 mm rivestito da uno strato di PVC antiurto e antigraffio resistente agli idrocarburi.

- Fori per la collocazione di una morsa 1599F/150 (da ordinare separatamente)
- Piedini regolabili in altezza

C55C7

Cassettiera mobile con sette cassetti da 588x367 mm, montati su guide telescopiche a sfera

- 4 ruote Ø 100 mm, 2 fisse (una con freno) e 2 girevoli
- Piano dei cassetti protetto da tappetini di gomma espansa
- Serratura centralizzata frontale

C55M7

Modulo fisso con sette cassetti da 588x367 mm, montati su guide telescopiche a sfera

- Piano dei cassetti protetto da tappetini di gomma espansa
- Serratura centralizzata frontale



C55PSP

2000 mm
160 mm
2050 mm

352 kg

~~€ 5.950,00~~
€ 3.450,00

C55M7

C55C7

C55 B-PRO

RSC 55

C55PSP

Parete portautensili

con tapparella e struttura portante

- Tapparella in alluminio, manovrabile verticalmente, con serratura
- Pannello forato amovibile per il sostegno degli utensili

Sistema a sgancio rapido in alluminio con possibilità di apertura su tutta la lunghezza del cassetto



Presca per aria compressa con arrotolatore da Ø 8 mm. Lunghezza: 10 m



Presca Schuko+16+10A
Presca EU Plug 16+10A

Predisposizione per l'inserimento dei termoformati



9563P
Poltrona Racing
professionale



RSC 55

La cassettera C55C7 è facilmente estraibile da parte dell'operatore grazie alle ruote girevoli

021140000

C14

Trolley portautensili in polipropilene con 4 cassetti, vuoto

- Struttura in polipropilene a iniezione che garantisce elevata resistenza agli urti.
- 4 robuste ruote posteriori
- Vassoio superiore removibile
- 3 vaschette porta minuteria incluse
- Targhetta identificativa portanome
- Predisposizione per la chiusura con lucchetto TSA

580x380x455 mm

~~€ 640,00~~
€ 370,00

10 kg



Pannello portautensili integrato nel coperchio



059140109

5914VU/M



Assortimento di 109 utensili per trolley C14, in termoformato morbido



70 MC T1



MC T2 29



10 MC T3

* per l'utilizzo in abbinamento con il trolley C14, occorre rimuovere il pannello portautensili superiore.

~~€ 854,00~~
€ 495,00



La parte anteriore, protetta dal coperchio frontale, ospita 4 cassette 470x255 mm estraibili:
 1 cassetto altezza 30 mm
 2 cassette altezza 60 mm
 1 cassetto altezza 90 mm

Due maniglie laterali

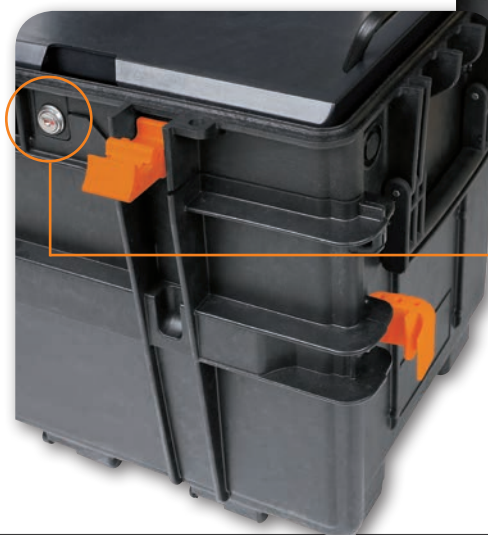

La serratura centralizzata frontale consente di chiudere contemporaneamente i due coperchi, quello superiore e quello frontale.

020370000

2037/TV

Trolley portautensili in polipropilene con 4 ruote pivotanti, vuoto

- Estremamente resistente agli urti. Indicato per il trasporto di utensili in aereo.
- 4 ruote pivotanti removibili che consentono la movimentazione orizzontale del trolley.
- 2 vaschette portaminuterie incluse
- Maniglia ergonomica rivestita in gomma

2 serrature omologate TSA con chiave



Tasca portadocumenti integrata.

€ 495,00
€ 285,00

7 kg

420x325x275 mm



2 pannelli portautensili removibili.



Ruote removibili

014980102

1498/2A



IP65

Caricabatterie elettronico 12V per motocicli

Permette la carica di tutti i tipi di batterie al Pb Wet, Agm, Gel, Mf, Vrla e delle batterie al Litio LiFePo4

- Due specifici tipi di carica per batterie al Litio e al Piombo
- Ciclo di ricarica multifase automatico
- Protezione contro inversione di polarità e corto circuito
- Grado di protezione IP65
- Include cavo con pinze e cavo con occhielli
- Tensione di alimentazione: 220-240V

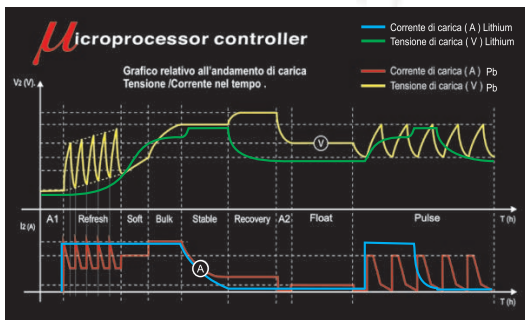

DATI TECNICI

Corrente di ricarica	1A
Capacità di ricarica	2Ah-40Ah
Frequenza	50-60 Hz
Tensione della batteria	12V
Dimensioni	180x80x40 mm
Peso	0,5 kg



Ideale per batterie al Litio di motocicli



€ 102,00
€ 58,00

☎ 014980030

1498CM/12



Avviatore d'emergenza portatile per motocicli

3 FUNZIONI IN 1:

- avviatore 12V
- batteria supplementare per apparecchi elettronici (tablet, smartphone, ecc...)
- torcia led ad alta luminosità

DATI TECNICI

Corrente di avviamento	200A
Corrente di picco	400A
Uscita USB	5V 2,1A
Dimensioni	130x50x15 mm
Peso	300 g



130 mm
300 g

~~€ 187,00~~
€ 105,00

Batteria di ultima generazione
LiFePo4



Porta in tasca
la tranquillità!

DOTAZIONE:

- cavo di avviamento con pinze isolate e diodo di protezione
- caricabatteria da rete
- caricabatteria da auto
- cavo USB con adattatori di carica



240x185x60 mm

Portatile
e multifunzione

014640500

1464APB

Nuovo

Set per la verifica dell'impianto alta pressione benzina dei motori FSI, da utilizzare con 1464T

Include sensore da 200 bar e raccordi di collegamento



~~€ 308,00~~
€ 177,00

240x210x50 mm

014640600

1464TDI

Nuovo

Set per la verifica della pressione della pompa nei motori TDI da utilizzare con 1464T

Include raccordo di collegamento



~~€ 95,00~~
€ 56,00

240x210x50 mm

014640450

1464AP

Set per la verifica dell'impianto alta pressione dei motori diesel common rail, da utilizzare con 1464T

- Set tubi alta pressione
- Raccordi di collegamento
- Sensore da 2.000 bar



~~€ 605,00~~
€ 348,00

430x310x50 mm



014640050

1464T

Tester digitale per la misurazione di pressione e compressione



~~€ 680,00~~
€ 390,00

009600510

960AD/TP2

Set di adattatori per 1464T

- Finti iniettori
- Finte candele
- Adattatori candela
- Adattatori tappi olio
- Raccordi iniezione benzina
- Set guarnizioni di ricambio



~~€ 398,00~~
€ 229,00

Nuovi set per il tester multifunzione

CARATTERISTICHE

- Display touch screen da 5"
- Batteria ai polimeri di lito ricaricabile
- Completo di sensore da 80 bar (basse pressioni) e cavo USB



014640550

1464PT

Nuovo

Set per la verifica della pressione del turbo da utilizzare con 1464T

Include sensore e cavo di collegamento

~~€ 134,00~~

€ 79,00

240x210x50 mm



014640650

1464PF

Nuovo

Set per la verifica della pressione nell'impianto frenante da utilizzare con 1464T

Include adattatori, sensori e raccordi

~~€ 555,00~~

€ 319,00

600x280x60 mm



014640350

1464IC

Set di finti iniettori e finte candele per 1464T

Permette di collegarsi al motore per la verifica della compressione nei motori diesel con tester digitale 1464T.

- N° 22 false candele
- N° 5 falsi iniettori
- N° 1 kit falso iniettore universale per truck, motori marini e macchine agricole

~~€ 445,00~~

€ 258,00

430x310x50 mm



559x312x50 mm



014620006

1462CF/C6

12"



Serie di 6 chiavi poligonali aperte per raccordi carburante iniettori

Misure incluse nella serie:
12-14-16-17-18-19 mm

260x145x60 mm



Agevole accesso al dado di fissaggio della connessione carburante

~~€ 75,00~~
€ 44,00

009600900

960UC

Set di utensili per estrazione candele bloccate con punta deformata M8-M9-M10

- Permette la presa rapida direttamente sull'esagono delle candele
- Dotato di innovativo sistema "fast lock" che garantisce la massima rapidità
- Non danneggia la testata motore e garantisce un lavoro professionale
- Estrazione a colpi tramite massa battente in dotazione

Ideale per candele bloccate e deformate



275x250x50 mm

~~€ 395,00~~
€ 227,00

009600940

960RPI

Attrezzo soffiatore per pulizia sede iniettori

Per motori con candele
M8x1 - M9x1 - M10x1 - M10x1.25

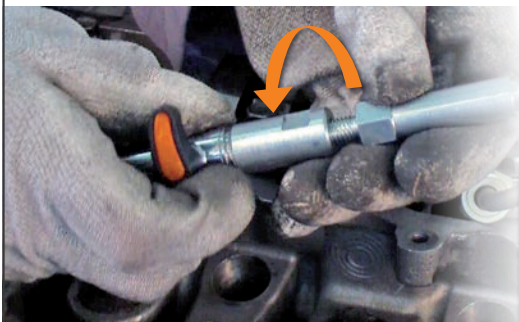

~~€ 150,00~~
€ 89,00

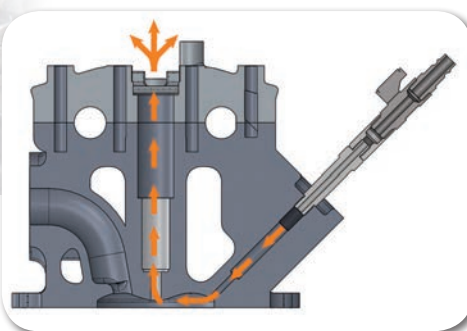

Fornito con:

- valvola con leva per l'interruzione del flusso dell'aria
- 4 prolunghe per sede candele

014620502

1462PIM

Coppia di piastre per manutenzione iniettori

Le piastre devono essere bloccate in morsa

Sezioni:
Ø 11-12-13-14-16-19-20 mm

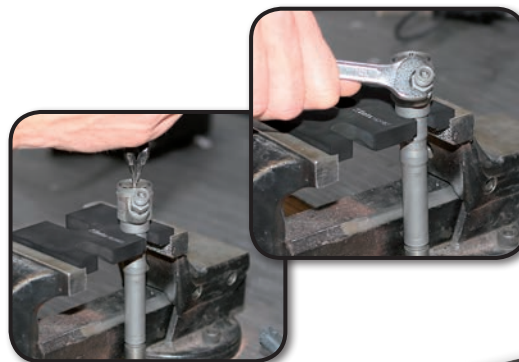

**Interventi
precisi e
in sicurezza**



~~€ 82,00~~
€ 47,00



018950060

1895 6



Vasca di lavaggio ad ultrasuoni da 6 litri

- Attraverso il riscaldamento del liquido e con l'azione degli ultrasuoni permette di pulire efficacemente parti di ricambio e pezzi metallici in genere (iniettori, carburatori, valvole, ecc...)
- Display digitale con regolazione della temperatura e del tempo di lavaggio
- Doppia funzione lavaggio: "soft" e "normal"
- Per una pulizia generale è sufficiente usare acqua ad una temperatura di 50/60°C
- Per una pulizia più accurata aggiungere soluzioni detergenti non schiumogene specifiche per vasche ad ultrasuoni
- La funzione degassificazione accelera la liberazione d'aria in tutto il volume della vasca aumentando l'efficacia degli ultrasuoni



DATI TECNICI	
Capacità vasca	6 litri
Rubinetto di scarico	
Potenza	150 Watt
Potenza di riscaldamento	300 Watt
Regolazione temperatura	0-80°C
Regolazione tempo di lavaggio	0-99 minuti
Frequenza	40 kHz
Alimentazione	220/230V

Capacità massima 6 litri



~~€ 560,00~~
€ 325,00



Ideale per iniettori



014850000

1485BP

Attrezzo a mezzaluna per bloccare le pulegge dentate

Regolabile tramite manico girevole, stringe e blocca la puleggia dall'esterno, evitando danni ai sensori circostanti

~~€ 175,00~~
€ 99,00



Universale

014850150

1485MJ

Attrezzo per bloccare l'albero a camme dei motori 1.3 16V Multijet

2 teste con 3 profili per operare su tutti i motori 1.3 16V Multijet montati da gruppo FCA, Opel, Ford e Suzuki

~~€ 99,00~~
€ 58,00

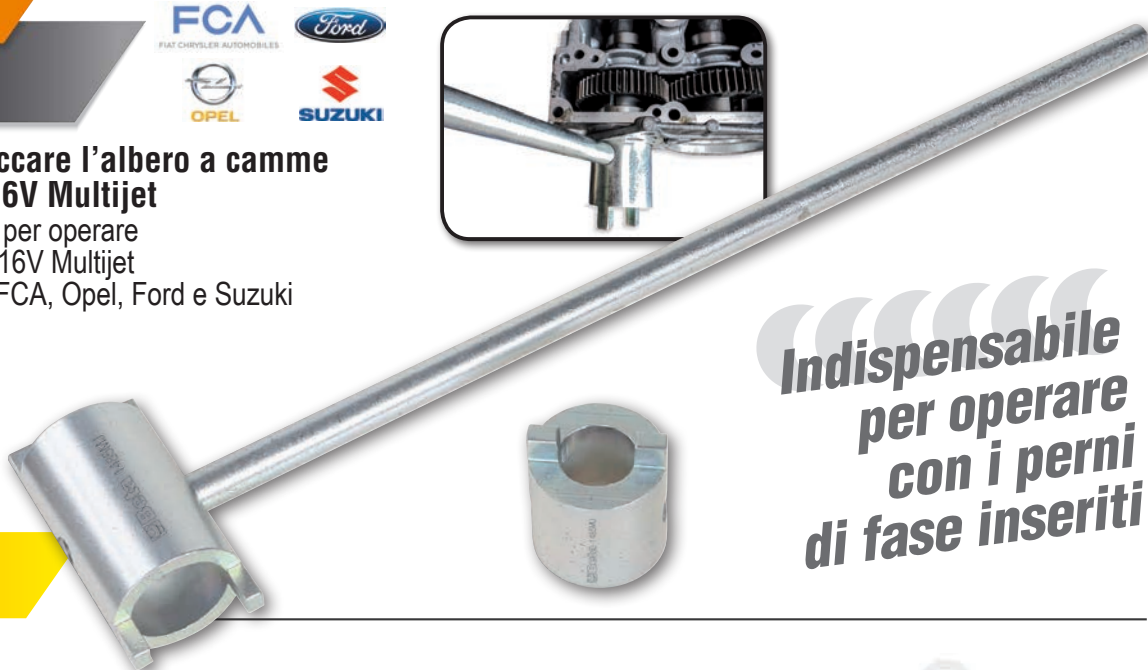

Indispensabile per operare con i perni di fase inseriti



014850080

1485VAG/K2

Coppia di attrezzi per precaricare i cuscinetti della cinghia di distribuzione

- Testa orientabile in 3 posizioni
- 1 attrezzo con testa profonda 12,5 mm
- 1 attrezzo con testa profonda 21,5 mm

~~€ 57,00~~
€ 33,00



017670000

1767A

L mm
640 = 1090

Asta telescopica

- Ideata per sostenere cofani e portelloni con pistoni scarichi
- Utilizzabile per mantenere i pedali bloccati

~~€ 54,00~~
€ 31,00



014930599

1493B/S5

38"

Serie di 5 chiavi poligonali per cartucce filtri olio di difficile accesso

Misure incluse nella serie:
24-27-32-36-38 mm

$\frac{+s}{-}$ mm
8

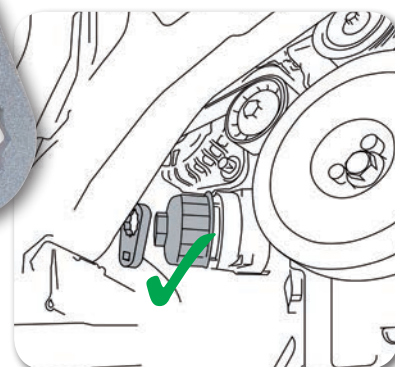
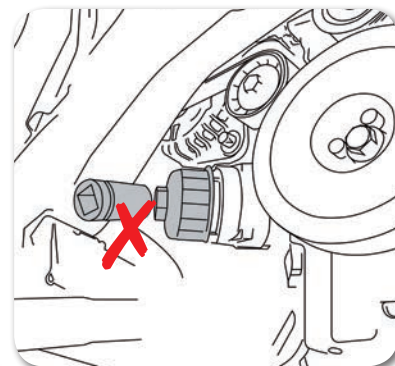

~~€ 63,00~~
€ 37,00

☎ 015480800

1548/C8



Estrattore di cuscinetti interni del cambio gruppo FCA e Opel

Comprende 2 coppie di griffe e 4 differenti supporti per adattarsi ai differenti modelli a partire dal 2007

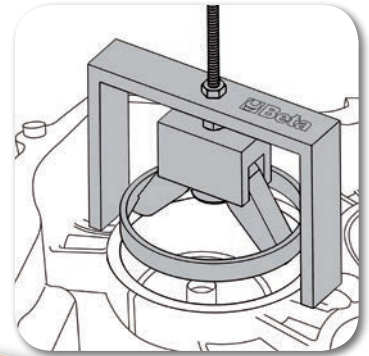
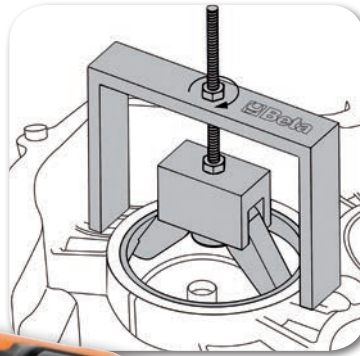

~~€ 445,00~~
€ 255,00

420x180x60 mm

☎ 014380200

1438DSG



Leva per bloccaggio/sbloccaggio cambio DSG a doppia frizione del gruppo VAG

Per cambio DSG

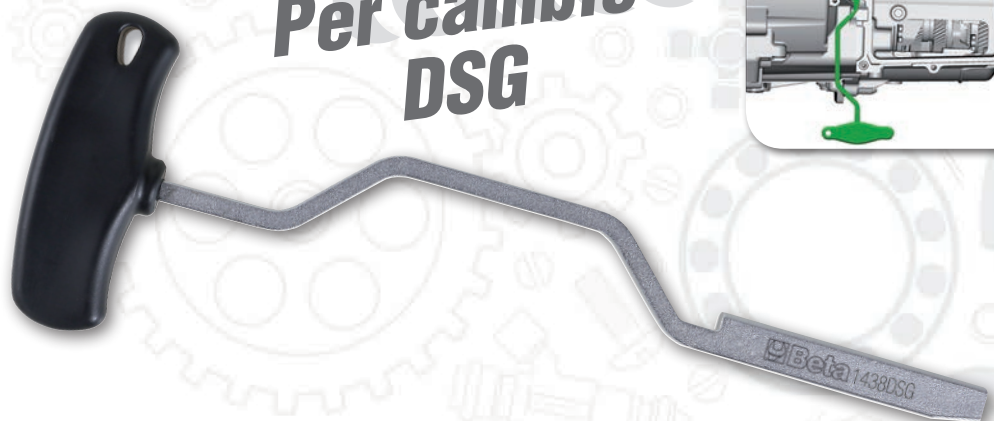
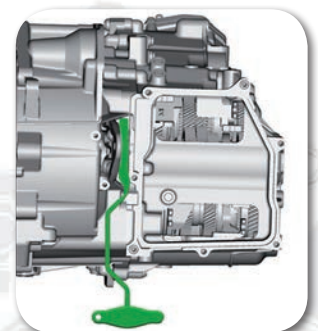

~~€ 22,00~~
€ 12,80

014720041

1472FCA

Pinza per rimozione fascette con cremagliera tipo Visa®

~~€ 29,00~~
€ 17,00



Facile apertura del blocco senza rischio di danneggiamenti

014730582

1473T

Tronchese per rimozione fascette in acciaio

Permette di tagliare le fascette senza rischiare il danneggiamento di cuffie, manicotti, ecc.

L mm	A max mm
220	14

~~€ 47,00~~
€ 27,50



Nessun rischio di danneggiamenti

014740200

1474G

Pinza a becchi lunghi piegati per cappucci candele di preriscaldamento

~~€ 35,00~~
€ 20,50



015690015

1569/B

Assortimento utensili per l'estrazione e l'introduzione di silent block, paraoli e cuscinetti ruota

- Estrazione diretta con chiave
- Facilità d'uso, non servono utensili pneumatici o idraulici
- Può essere utilizzato in abbinamento al kit Beta 1569/A

Il kit include:

- barre filettate, rondelle e boccole per diametri 14-32 mm

Diametri da 14 a 32 mm



~~€ 643,00~~
€ 373,00

530x415x115 mm

015580100

1558/C4

Attrezzo per anelli seeger interni ed esterni con azionamento a vite

Grazie all'attacco quadro si applica una forza elevata in entrambe le condizioni d'utilizzo

Puntali in dotazione:
Ø 2,5-3-3,5 mm



330x220x50 mm



38

~~€ 128,00~~
€ 75,00

014970170

1497CEL

**Utensile per la rimozione
dei connettori elettrici
del gruppo VAG**

Permette di scollegare rapidamente
i connettori senza danneggiarli

~~€ 15,00~~
€ 8,80

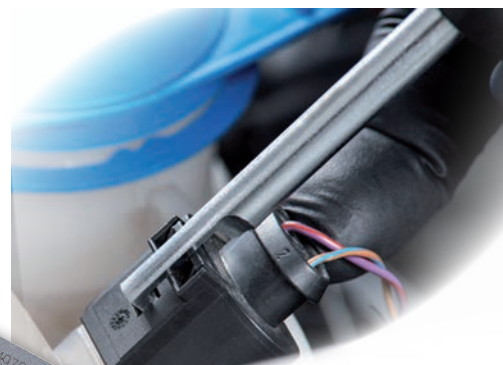

014820014

1482A/4

**Chiave per ghiera
galleggianti serbatoio
a 5 denti**

Utilizzabile su vetture gruppo FCA
come Freemont, 500L, 500X,
Renegade...

~~€ 74,00~~
€ 43,50



FCA
FIAT CHRYSLER AUTOMOBILES

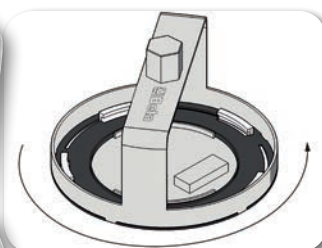
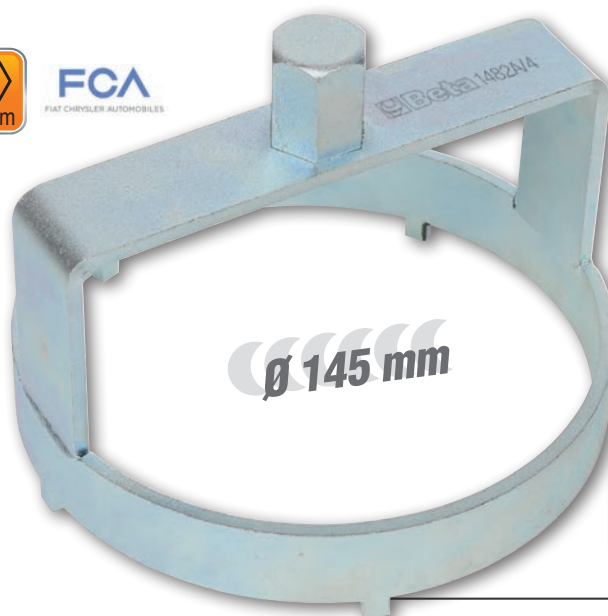

014820015

1482A/5

**Chiave per ghiera
galleggianti serbatoio
a 22 settori**

Per agire sulla ghiera
in plastica montata sulle vetture
del gruppo VAG

~~€ 54,00~~
€ 31,50

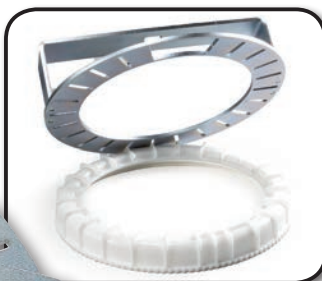

014660100

1466/C5



Kit 5 chiavi per spurgo freni

Inclusi nel kit:

- 5 chiavi misura 7-8-9-10-11 mm
- 1 tubo di scarico con valvola di non ritorno



260x170x50 mm



~~€ 99,00~~
€ 58,00

*L'olio passa
all'interno
della bussola*

*Non serve rimuovere
la chiave per
effettuare lo spurgo*

009840005

984

Pinza per le coperture plastiche dei dadi ruota



L mm	H mm
195	4

~~€ 19,50~~
€ 11,50

022580011

2258-0

Seggiolino con cassettera, vuoto

- Altezza totale 450 mm
- Vaschetta porta utensili frontale
- 4 ruote pivotanti



3 cassetti con guide telescopiche

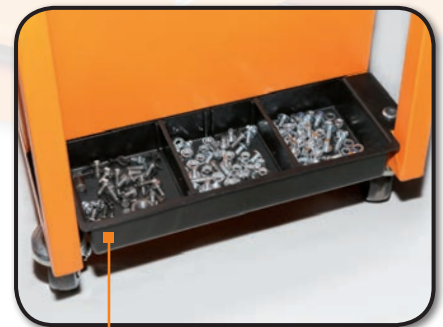

Vaschetta porta minuterie posteriore con separatori

~~€ 148,00~~
€ 86,00

10,2 kg
450 mm
475 mm
355 mm

022540047

2254T

Tappeto per protezione ginocchia
Realizzato in EVA antiscivolo



~~€ 21,50~~
€ 12,50

30 mm
290 mm
470 mm



022510011

2251-0

Seggiolino girevole con cassetti, vuoto

- Seduta tonda girevole con altezza regolabile tramite pistone a gas (430÷560 mm)
- 4 ruote pivottanti



11,5 kg
430÷560 mm
380 mm
380 mm

~~€ 142,00~~
€ 82,00

Base quadrata da 380 mm con 2 cassetti su un lato e 1 cassetto su altro lato



Per lavorare comodamente con ogni cosa a portata di mano

022500011

2250-0

Seggiolino girevole con vassoio

- Seduta tonda girevole
- Altezza regolabile tramite pistone a gas (410÷530 mm)
- 5 ruote pivottanti



2 portaminuterie/portautensili di cui uno regolabile in altezza

~~€ 78,00~~
€ 45,00

6 kg
410÷530 mm
380 mm
380 mm

013670100

1367/S6

Serie di fustelle per l'installazione dei sensori di parcheggio

Misure incluse nella serie:
Ø 17 - 18 - 19 - 20 - 21 - 22 mm

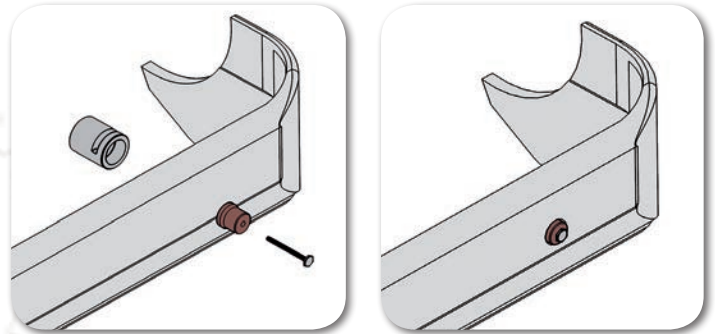

~~€ 194,00~~
€ 113,00

Fori perpendicolari e senza sbavature

013620010

1362

Piastra di riscontro bolli applicabile con ventosa

Permette di rilevare anche le più piccole imperfezioni della carrozzeria

LxH
mm
240x200



Utilizzabile in tutte le posizioni

~~€ 63,00~~
€ 36,00

013660200

1366A

Attrezzo levabolli con kit di 19 funghetti di plastica

Da utilizzare con colla a caldo per superfici verniciate.

Ideale per:

- bolli da grandine
- ammaccature causate da portiera
- piccole ammaccature in genere



Veloce e funzionale



~~€ 69,00~~
€ 40,00

013660205

1366/KF

Kit di 19 funghetti di plastica per attrezzi levabolli

~~€ 25,00~~
€ 14,50

013600006

1360/K6

Martello in alluminio con testa tonda piana, puntali di plastica intercambiabili e bulino

Fornito con:

- 4 puntali di plastica
- 1 bulino regolabile in 2 differenti lunghezze applicabile al martello



Pratico manico porta-accessori



L mm	Ø mm
320	34

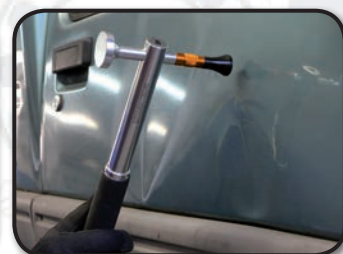

~~€ 69,00~~
€ 40,00

014780151

1478/3P

Pinza per pioli in plastica
con 3 punti di sblocco

~~€ 51,00~~
€ 29,50

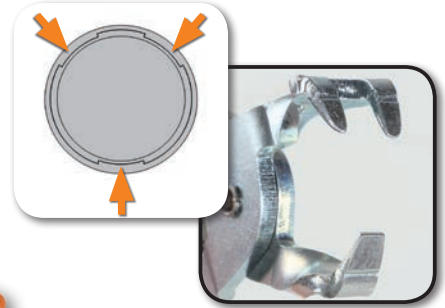
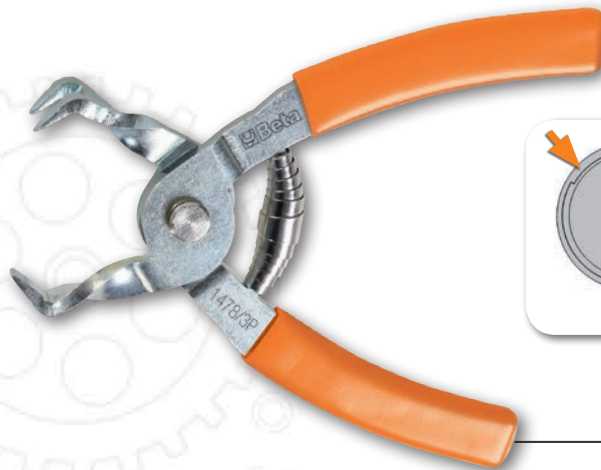

014790510

1479L/S2

Coppia di leverini multifunzione
in Teflon®

*Alta resistenza
allo sforzo*

~~€ 29,00~~
€ 17,00



*Molteplici impieghi
con solo due utensili*

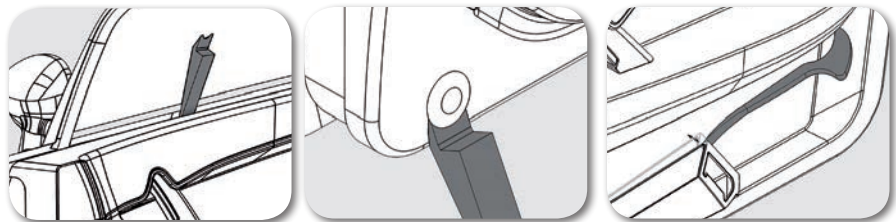

017630001

1763

Pinza per graffette
tappezzerie auto

~~€ 24,00~~
€ 14,00



170 mm

017630105

1763G/S500

500 graffette
per tappezzerie auto



~~€ 52,00~~
€ 30,00

019370171

1937KC



Mini levigatrice orbitale

- Fornita con due platorelli di levigatura da Ø 50 mm e Ø 75 mm,
- Assortimento di 10 dischi, per ciascuna misura, di carta abrasiva con grana 400, 600, 800
- Impugnatura a pistola
- Regolatore di potenza
- Regolatore di portata in ottone*
- Adatta per le operazioni di finitura in spazi ristretti

Compatta e leggera: 640 g



280x280x90 mm

Velocità libera	giri/min	15000
Potenza	KW	0,25
Dimensione platorello	mm	50 - 75
Filettatura albero		M6 x 1,0
Attacco aria	GAS	1/4"
Pressione utilizzo	bar	6,2
Ø interno tubo aria	mm	10
Consumo aria medio	l/min	79
Peso kit	kg	1,4



~~€ 198,00~~
€ 115,00



013440010

1344

Coppia di spessimetri per carrozzieri a 10 lame con ventosa di fissaggio

Indicati per:

- posizionamento lunotti
- mantenimenti della posizione durante i montaggi



~~€ 29,00~~
€ 17,00

018380201

1838SLR



Lampada a LED snodata ricaricabile

- LED compatto frontale (200 lumen) e in testa per ispezioni (100 lumen)
- Corpo illuminante di soli 9 mm di spessore
- Autonomia di 5/2.5 ore (in base al livello di luce impostato)
- Con caricatore USB
- Con gancio metallico e magnete

Sottilissima

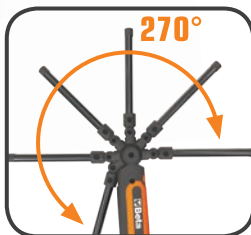

~~€ 82,00~~
€ 49,00



Compatta e versatile

- COB LED
Spot: High power LED
- 5/2.5h
Spot: 3h
- 3.7V / 1200 mAh
Li-ion
- 100/200 lumen
Spot: 100 lumen
- 3h
- 10° to +40°
- IP30
- 242x41x30 mm
- 101g

019470051

1947G



Pistola pneumatica per ingrassaggio

- Funziona con cartucce da 400 g o grasso fuso fino a 500 cc
- Testa pressofusa in alluminio
- Impugnatura ergonomica con figura a spigolo per accedere in spazi ristretti
- Dimensioni del tubo: 54 (interno) x 260 mm

Erogazione	g/min	400
Dimensioni del tubo	mm	54x260
Attacco aria	GAS	1/4"
Pressione d'utilizzo	bar	3÷10
Peso	kg	1,16



260 mm

54 mm

~~€ 128,00~~
€ 75,00

017500100

1750KG10

Ingrassatore a leva da 10 kg con tubo ad alta pressione da 2 m

- Dotato di raccordo girevole per non strozzare il tubo
- Corpo pompante in alluminio pressofuso con valvola di sfiato



~~€ 149,00~~
€ 88,00



3 differenti livelli di pressione impostabili:

- 4 gr - 275 bar
- 7 gr - 206 bar
- 9 gr - 137 bar

10 kg

3,5 kg

017500111

1750TA

Testina per ingrassaggio autobloccante a 6 spilli ad alta pressione

- Agevole disconnessione anche con testina in pressione
- Filetto M10x1: adatto a tutti i tipi di ingrassatore: elettrico, pneumatico, manuale, ecc.
- Nessuna deformazione fino a 550 bar

Autobloccante



Resiste fino a 550 bar

Una volta posizionata rimane in asse e collegata al nipplo.

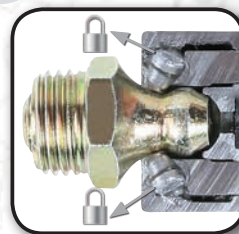

~~€ 35,00~~
€ 20,00

008670938

867/C38



Assortimento di 38 inserti con attacco esagonale 10 mm e 1 portainseriti a T snodato in termoformato morbido

	852	⊕	10 mm - L 400 mm
	867PE	○	4-5-6-7-8-10-12 mm
	867PE/L	○	4-5-6-7-8-10-12 mm
	867XZN	○	M5-M6-M8-M10-M12
	867XZN/L	○	M5-M6-M8-M10-M12
	867TX	⊕	T20-T25-T30-T40-T45-T50-T55
	867TX/L	⊕	T20-T25-T30-T40-T45-T50-T55

852

Nuovo portainseriti a T snodato



~~€ 153,00~~
€ 88,00

420x185x60 mm

000970364

97BTXL/SC8



Serie di 8 chiavi maschio piegate con un'estremità sferica, modello lungo per viti con impronta Torx®



Supporto con sistema di bloccaggio delle chiavi



Modello lungo +25%

⊕ T9-T10-T15-T20-T25-T27-T30-T40

~~€ 70,00~~
€ 38,00

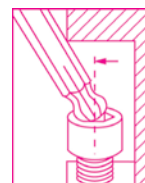

7212FG



Scarpe in pelle scamosciata traforata con inserto antiabrasione nella zona del puntale

- Puntale in composito
- Lamina antiperforazione in fibra composita
- Suola in poliuretano monodensità

~~€ 57,00~~
€ 32,90



EU	UK	
35	2,5	072120035
36	3,5	072120036
37	4,5	072120037
38	5	072120038
39	6	072120039
40	6,5	072120040
41	7	072120041
42	8	072120042
43	9	072120043
44	10	072120044
45	10,5	072120045
46	11	072120046
47	12	072120047
48	13	072120048



EN ISO 20345 2011
S1P SRC

7213FG



Scarpe in pelle scamosciata con inserti in mesh ad alta traspirazione

- Puntale in composito
- Lamina antiperforazione in fibra composita
- Suola in poliuretano monodensità

~~€ 57,00~~
€ 32,90



EU	UK	
35	2,5	072130035
36	3,5	072130036
37	4,5	072130037
38	5	072130038
39	6	072130039
40	6,5	072130040
41	7	072130041
42	8	072130042
43	9	072130043
44	10	072130044
45	10,5	072130045
46	11	072130046
47	12	072130047
48	13	072130048



EN ISO 20345 2011
S1P SRC

7214FN



Scarpe in action nabuk idrorepellente con inserto antiabrasione nella zona del puntale

- Puntale in composito
- Lamina antiperforazione in fibra composita
- Suola in poliuretano monodensità

~~€ 62,00~~
€ 35,50



EU	UK	
35	2,5	072140035
36	3,5	072140036
37	4,5	072140037
38	5	072140038
39	6	072140039
40	6,5	072140040
41	7	072140041
42	8	072140042
43	9	072140043
44	10	072140044
45	10,5	072140045
46	11	072140046
47	12	072140047
48	13	072140048



EN ISO 20345 2011
S3 SRC

Beta Utensili S.p.A.
Via Volta 18
20845 Sovico (MB)
Tel. 039.2077.1
Fax 039.2010742
www.beta-tools.it

 **Beta**
2017

998023851

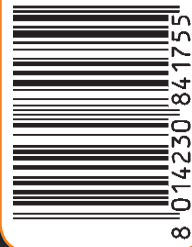

Promozione valida dal 24/5/2017 al 31/12/2017. Prezzi netti I.V.A. esclusa

Le immagini sono indicative, Beta si riserva il diritto di apportare aggiornamenti e migliorie alla propria gamma produttiva senza alcun preavviso.