

# IMPORTANT/WICHTIG/ATENCIÓN

## IMPORTANT/IMPORTANTE



EN - We recommend **1** or more people to install.  
DE - Wir empfehlen, dass die Montage von **1** oder mehreren Personen durchgeführt werden sollte.  
ES - Recomendamos realizar el ensamble con **1** o más personas.  
FR - Il est recommandé d'effectuer le montage à **1** personne(s) ou plus.  
IT - È necessaria la presenza di **1** o più persone per il montaggio di questo prodotto.



EN - The expected assembly time is **1 h**.  
DE - Die Montagezeit beträgt durchschnittlich **1 h**.  
ES - El tiempo aproximado de ensamble es de **1 h**.  
FR - Le temps nécessaire est estimé à **1 h**.  
IT - Il tempo previsto per il corretto assemblaggio è di **1 h**.



EN - Not intended for use by children.  
DE - Nicht geeignet für Kinder.  
ES - Producto no apto para niños.  
FR - Produit non destiné à être utilisé par des enfants.  
IT - Questo prodotto non è destinato all'uso da parte dei bambini.



EN - Keep away from fire or other heat sources.  
DE - Bitte von Feuer und Hitzequellen fernhalten.  
ES - Manténgase alejado de las llamas y otras fuentes de calor.  
FR - Tenir à distance des flammes et autres sources de chaleur.  
IT - Tenere lontano dal fuoco o da altre fonti di calore.



EN - We recommend wearing protective gloves.  
DE - Wir empfehlen das Tragen von Schutzhandschuhen.  
ES - Recomendamos el uso de guantes de seguridad.  
FR - Il est recommandé de porter des gants de protection.  
IT - Per il processo di assemblaggio, consigliamo fortemente l'utilizzo di guanti protettivi.



EN - Please contact us via **help@yaheetech.shop** if you need assistance.  
DE - Bitte kontaktieren Sie unseren Kundenservice per E-Mail: **help@yaheetech.shop** für weitere Hilfe.  
ES - Si necesita ayuda, por favor póngase en contacto con nosotros a través de **help@yaheetech.shop**.  
FR - Besoin d'aide? Contactez-nous via **help@yaheetech.shop**.  
IT - Per assistenza o maggiori informazioni, puoi contattarci all'indirizzo mail **help@yaheetech.shop**.

**EN** - Please follow the instruction manuals and use a pad to avoid damage during assembly.









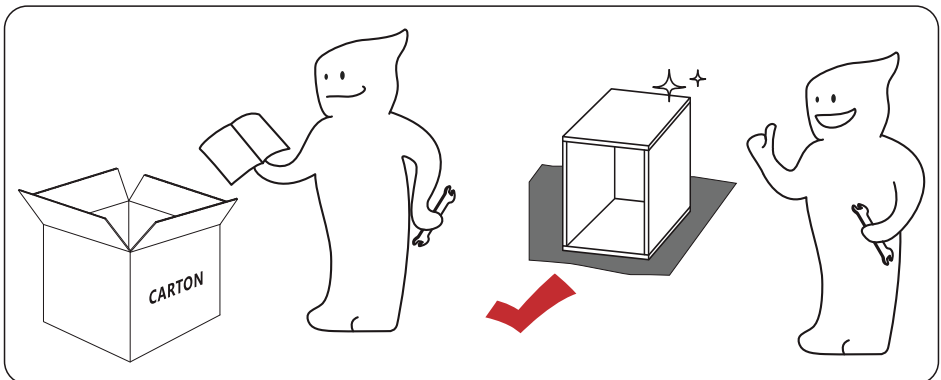
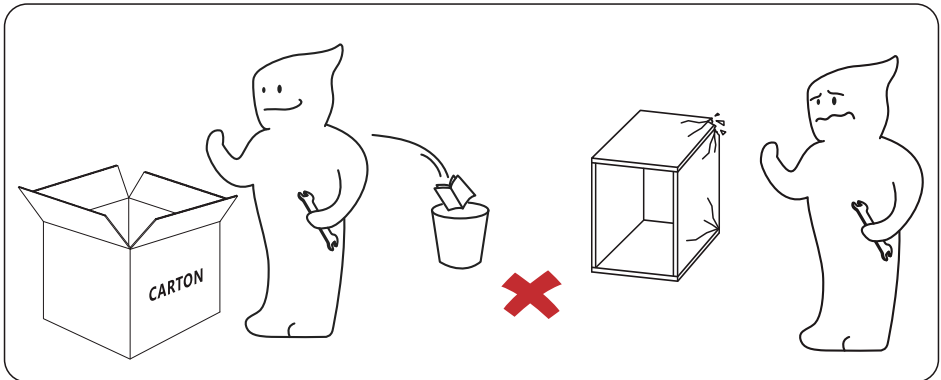

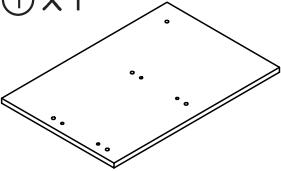
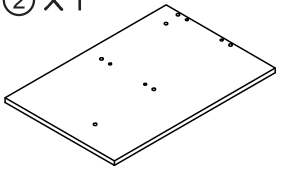
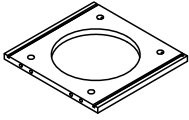
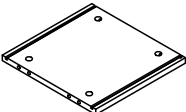
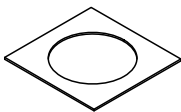
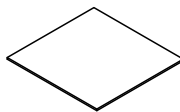
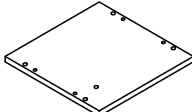
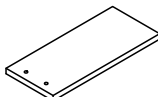
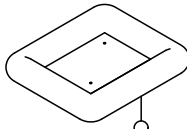
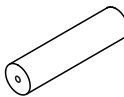
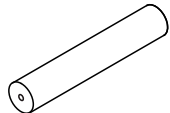

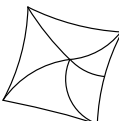

**DE** - Bitte folgen Sie der Anleitung und verwenden Sie eine Unterlage, um Beschädigungen bei der Montage zu vermeiden.

**ES** - Por favor siga las instrucciones del manual y utilice una cubierta o lona para proteger el producto y los suelos durante la instalación.

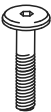

**FR** - Suivez les instructions de la notice et utilisez une couverture ou une bâche pour protéger le produit et les sols pendant le montage.

**IT** - Si prega di consultare il manuale illustrativo durante il montaggio e di utilizzare un cuscinetto per evitare possibili danni.

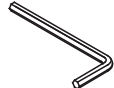



① × 1 	② × 1 	③ × 2 		
④ × 2 	⑤ × 2 	⑥ × 2 	⑦ × 1 	
⑧ × 1 	⑨ × 1 	⑩ × 1  18.5CM	⑪ × 1  28.5CM	
⑫ × 2  24CM	⑬ × 1 	⑭ × 2 	⑮ × 1 	⑯ × 1 
⑰ × 1 	Ⓐ × 16 	Ⓑ × 16 	Ⓒ × 16 	Ⓓ × 4 
Ⓔ × 6 	Ⓕ × 1 	Ⓖ × 4 	Ⓗ × 2 	Ⓘ × 1 

1

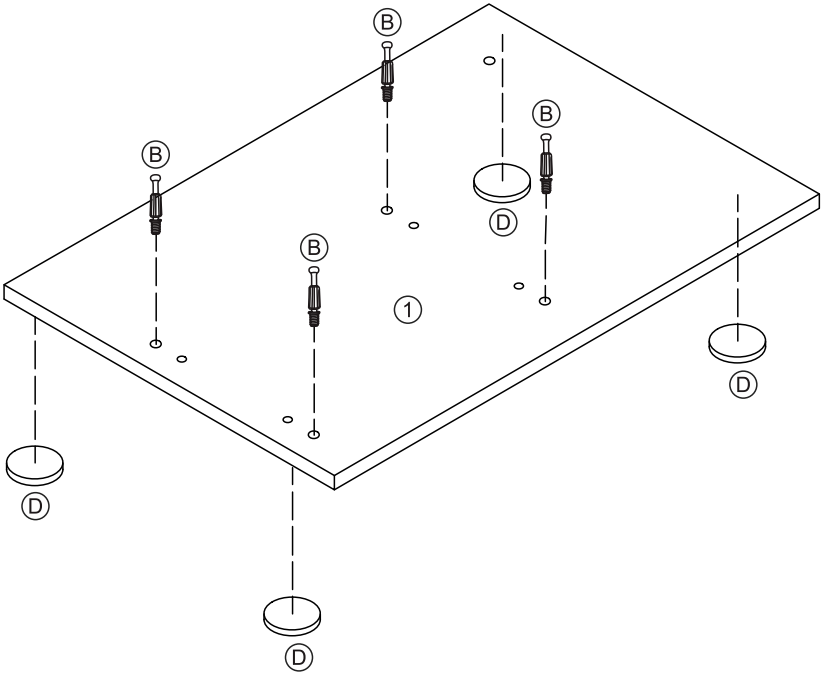
①		x1
Ⓑ		x4
Ⓓ		x4







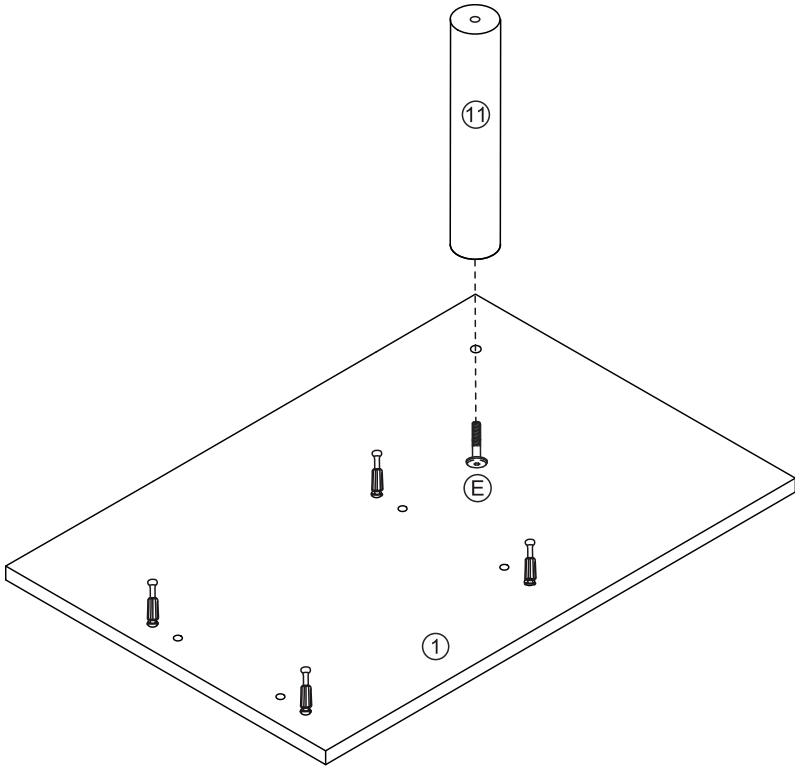

2

(11)	 x1
(E)	 x1





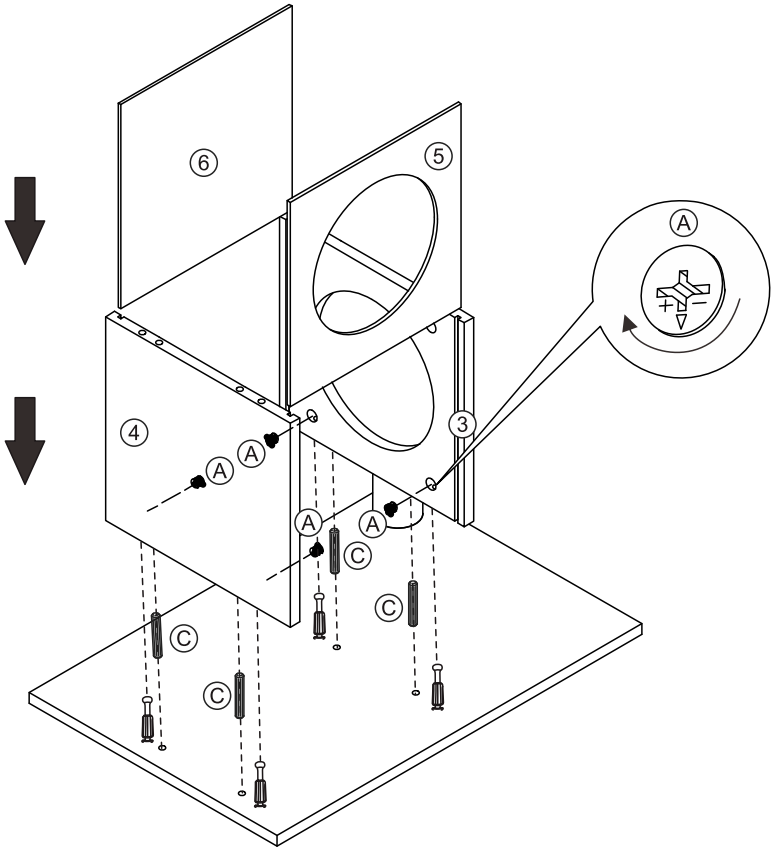

3

③	 x1	④	 x1	⑤	 x1	⑥	 x1
Ⓐ	 x4	Ⓒ	 x4				



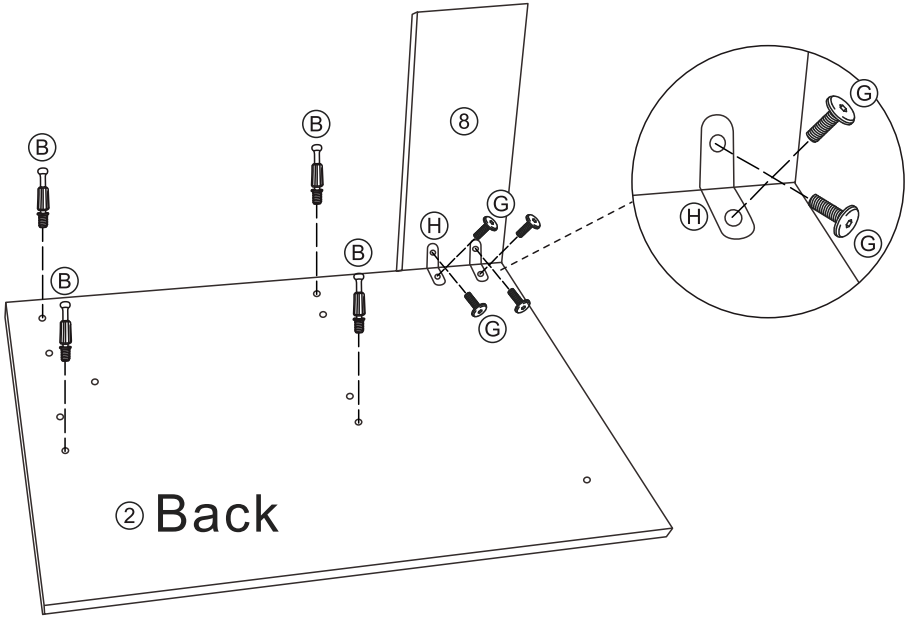
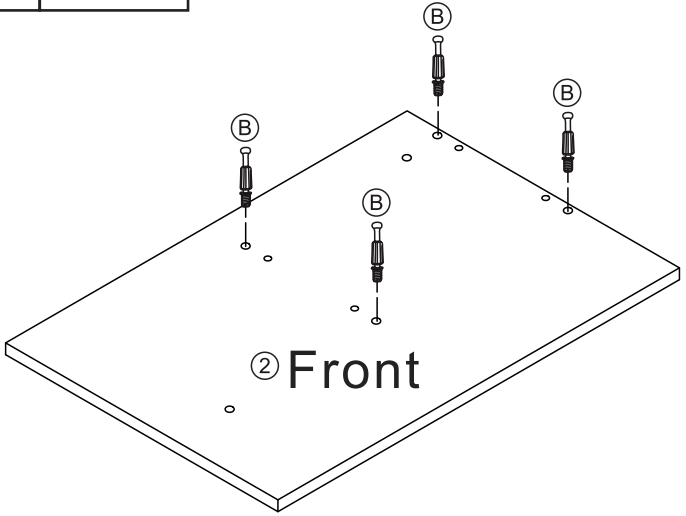

4

②	 x1	⑧	 x1	Ⓑ	 x8	Ⓒ	 x4
Ⓗ	 x2						



5

(A)	 x4	(C)	 x4	(E)	 x1
-----	--	-----	--	-----	--

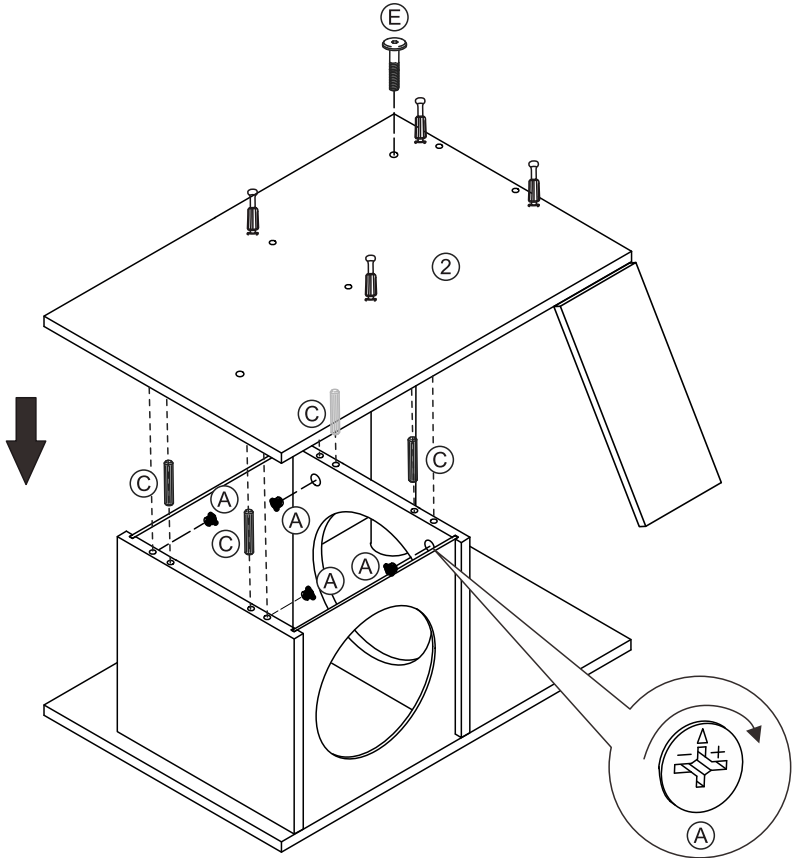





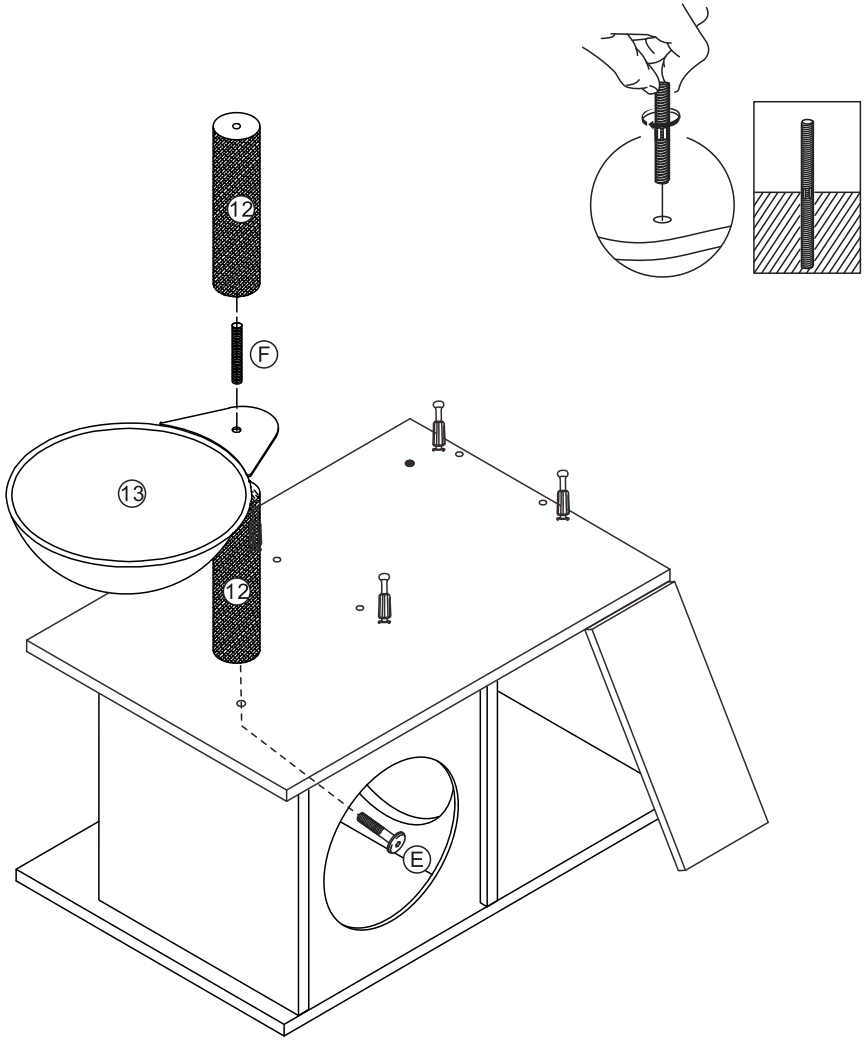
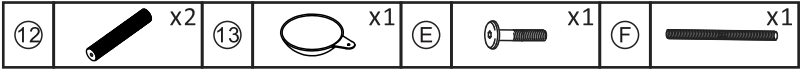



6



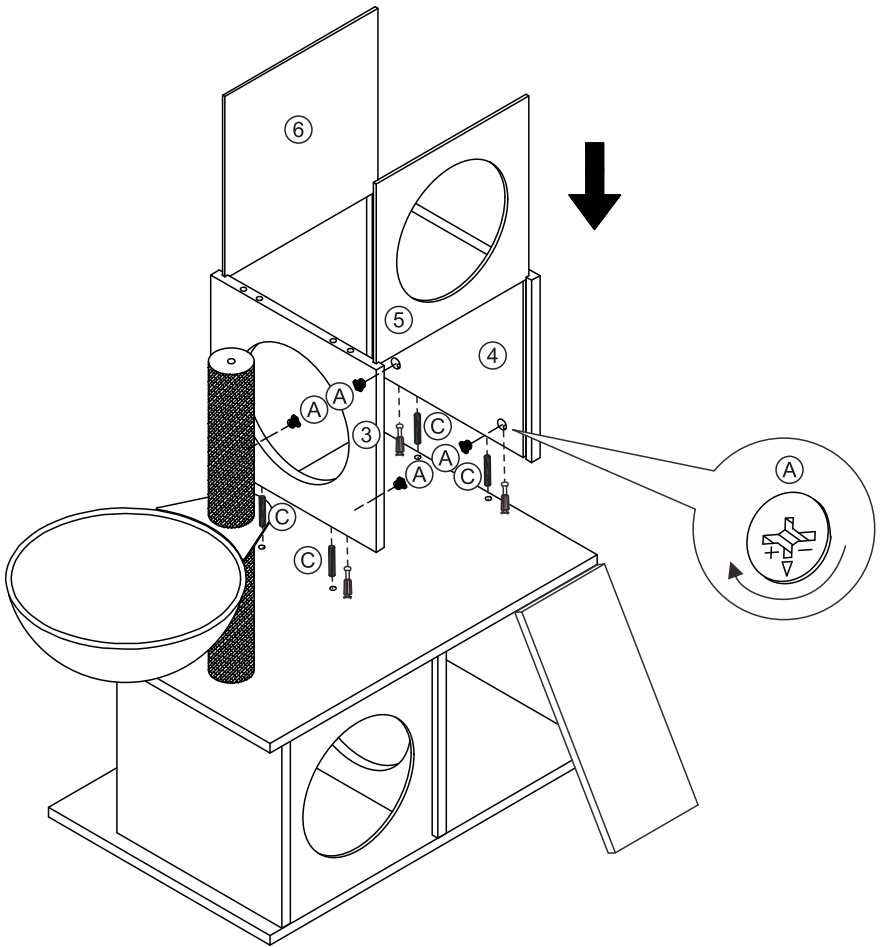

7

③	 x1	④	 x1	⑤	 x1	⑥	 x1
Ⓐ	 x4	Ⓒ	 x4				



8

⑦	 x1
Ⓑ	 x4

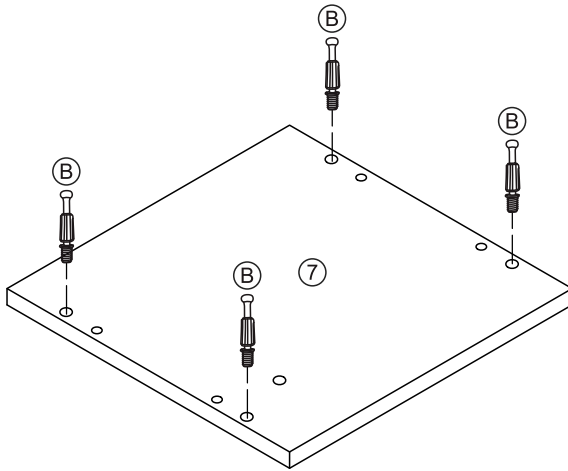

9

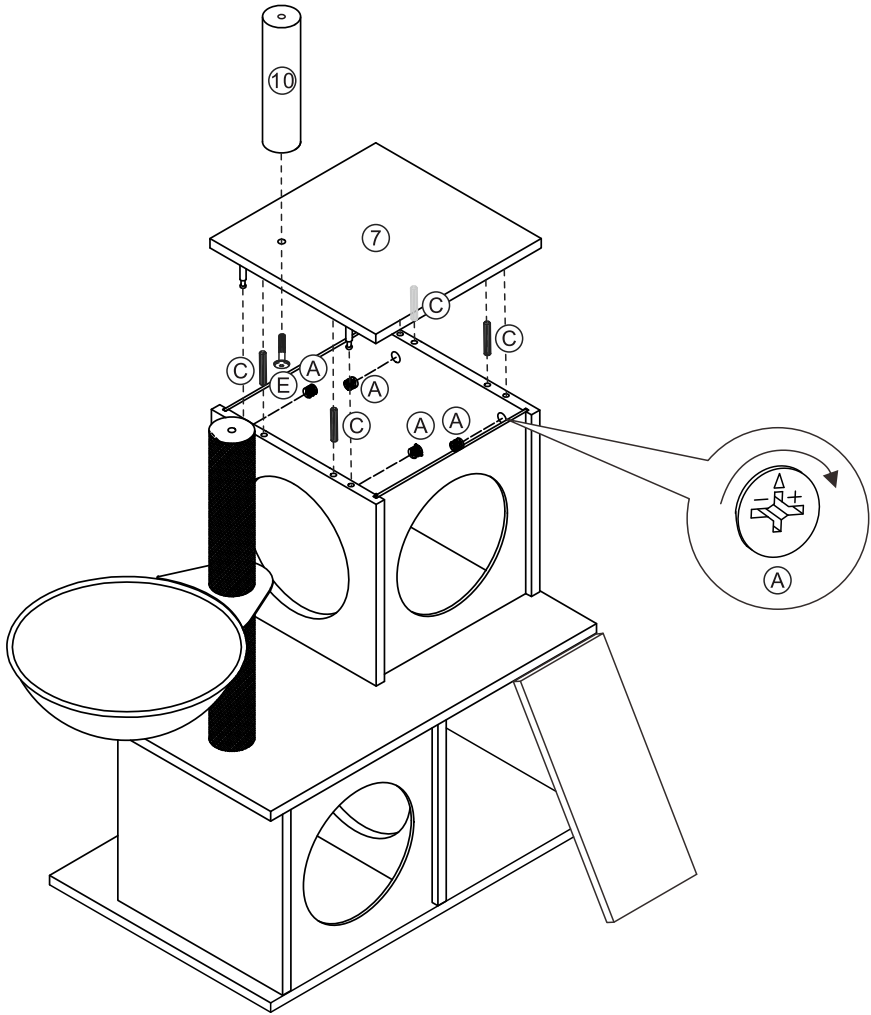
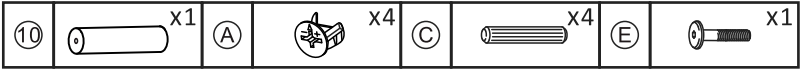

10

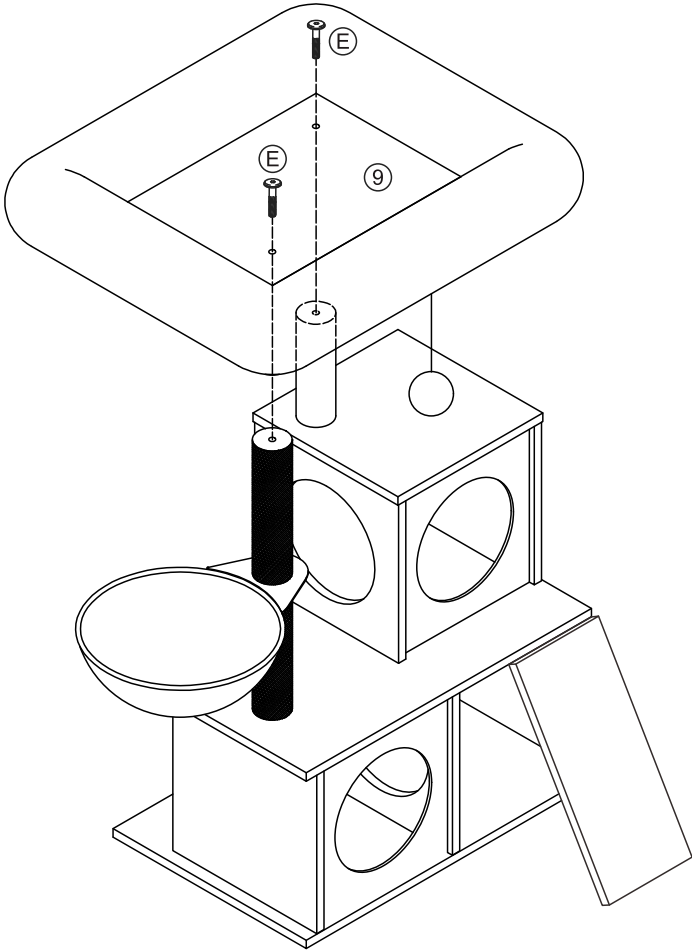
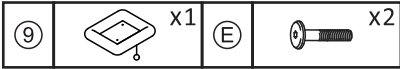

# 11

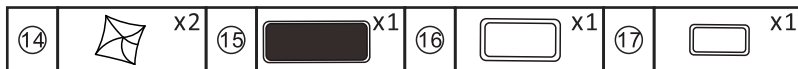

**EN** - When installing mat (15), (16) and (17), please tear off the white stickers.

**DE** - Bei Montage der Matten (15), (16) und (17), bitte die weißen Schutzaufkleber entfernen.

**ES** - Cuando instale la placa(15) , (16) y(17), por favor retire los adhesivos blancos.

**FR** - Pour installer les tapis (15), (16) et (17), veuillez enlever les autocollants blancs.

**IT** - Durante l'applicazione dei tappetini (15), (16) e (17), si prega di rimuovere gli adesivi bianchi.

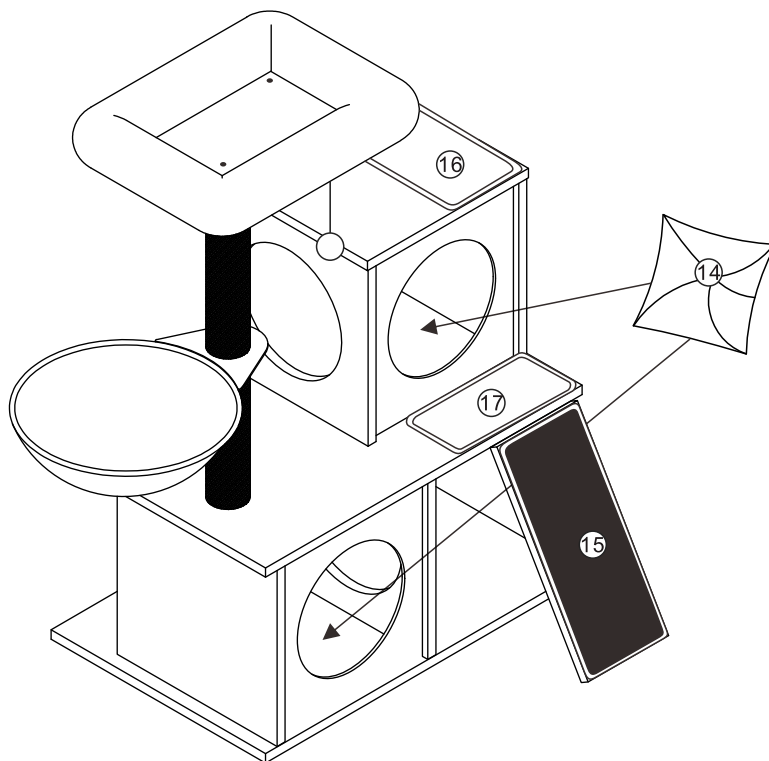

EN



**Good job.** Would you like to share your experience to assist others with their shopping decisions?



**Not good.** If you are not satisfied with this shopping experience, please contact us via [help@yaheetech.shop](mailto:help@yaheetech.shop).

DE



**Gut.** Wollen Sie Ihre Erfahrungen teilen, um anderen Kunden bei ihrer Kaufentscheidung zu helfen?



**Nicht gut.** Wenn Sie mit diesem Einkaufserlebnis nicht zufrieden sind, kontaktieren Sie unseren Kundenservice per E-Mail: [help@yaheetech.shop](mailto:help@yaheetech.shop) für weitere Hilfe.



Hergestellt in PRC für Yahee GmbH

Importeur: Yahee GmbH

Hans-Grüninger-Weg 11

71706 Markgröningen

Willkommen auf unserer Webseite, Web: [www.yaheetech.de](http://www.yaheetech.de)

ES



**Satisfecho.** ¿Le gustaría compartir su experiencia para ayudar a otros clientes en su compra?



**Insatisfecho.** Si no está satisfecho con su compra, póngase en contacto con nosotros a través de [help@yaheetech.shop](mailto:help@yaheetech.shop).

FR



**Satisfait.** Souhaitez-vous partager votre expérience pour aider d'autres potentiels clients dans leur choix ?



**Mécontent.** Si vous n'êtes pas satisfait de votre achat, contactez-nous via [help@yaheetech.shop](mailto:help@yaheetech.shop).

IT



**Soddisfatto.** Ti piacerebbe condividere la tua esperienza con gli altri utenti?



**Insoddisfatto.** Se non sei soddisfatto della tua esperienza, si prega di contattarci all'indirizzo mail: [help@yaheetech.shop](mailto:help@yaheetech.shop).

EN - You can also get a downloadable user manual by scanning the QR code below.

DE - Sie können auch ein herunterladbares Benutzerhandbuch erhalten, indem Sie den QR-Code unten scannen.

ES - Puede descargar una versión digital escaneando el siguiente código QR.

FR - Vous pouvez télécharger une version digitale en scannant le code QR ci-dessous.

IT - Puoi scaricare il libretto delle istruzioni scannerizzando il codice QR in fondo alla pagina.



611332

[www.yaheeshop.com/pdf/all-1-6011958.pdf](http://www.yaheeshop.com/pdf/all-1-6011958.pdf)