

# IMPORTANT/WICHTIG/ATENCIÓN

## IMPORTANT/IMPORTANTE



**EN** - We recommend **2** or more people to install.  
**DE** - Wir empfehlen, dass die Montage von **2** oder mehreren Personen durchgeführt werden sollte.  
**ES** - Recomendamos realizar el ensamble con **2** o más personas.  
**FR** - Il est recommandé d'effectuer le montage à **2** personne(s) ou plus.  
**IT** - È necessaria la presenza di **2** o più persone per il montaggio di questo prodotto.



**EN** - The expected assembly time is **1 h**.  
**DE** - Die Montagezeit beträgt durchschnittlich **1 h**.  
**ES** - El tiempo aproximado de ensamble es de **1 h**.  
**FR** - Le temps nécessaire est estimé à **1 h**.  
**IT** - Il tempo previsto per il corretto assemblaggio è di **1 h**.



**EN** - Not intended for use by children.  
**DE** - Nicht geeignet für Kinder.  
**ES** - Producto no apto para niños.  
**FR** - Produit non destiné à être utilisé par des enfants.  
**IT** - Questo prodotto non è destinato all'uso da parte dei bambini.









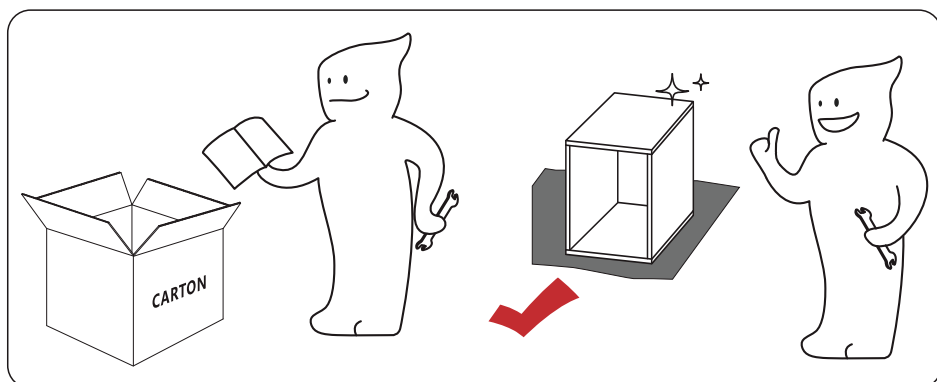
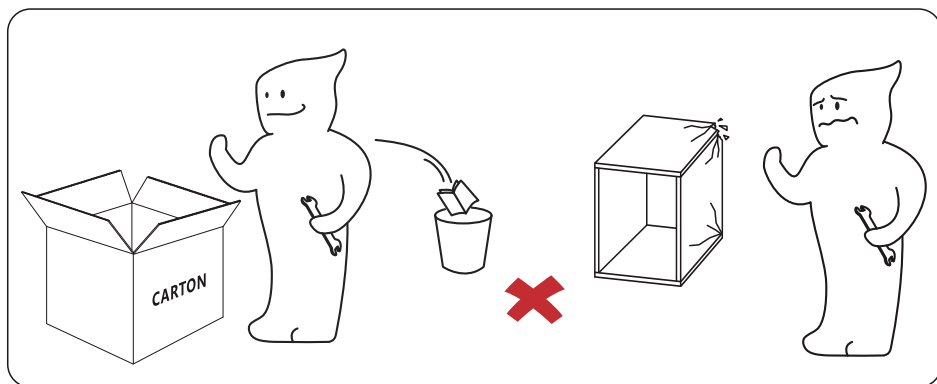

**EN** - Keep away from fire or other heat sources.  
**DE** - Bitte von Feuer und Hitzequellen fernhalten.  
**ES** - Manténgase alejado de las llamas y otras fuentes de calor.  
**FR** - Tenir à distance des flammes et autres sources de chaleur.  
**IT** - Tenere lontano dal fuoco o da altre fonti di calore.

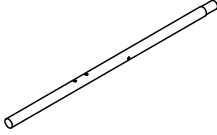
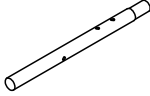
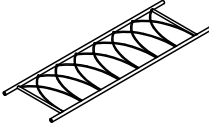
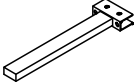
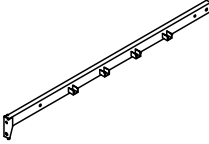
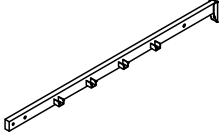
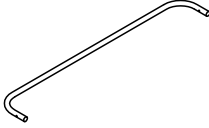
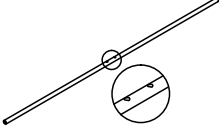
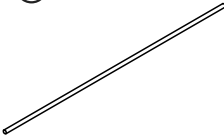
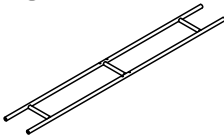
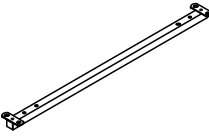
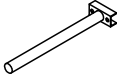
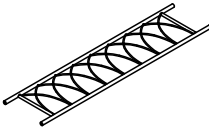
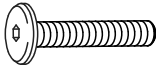

**EN** - We recommend wearing protective gloves.  
**DE** - Wir empfehlen das Tragen von Schutzhandschuhen.  
**ES** - Recomendamos el uso de guantes de seguridad.  
**FR** - Il est recommandé de porter des gants de protection.  
**IT** - Per il processo di assemblaggio, consigliamo fortemente l'utilizzo di guanti protettivi.





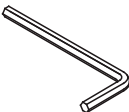
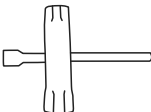

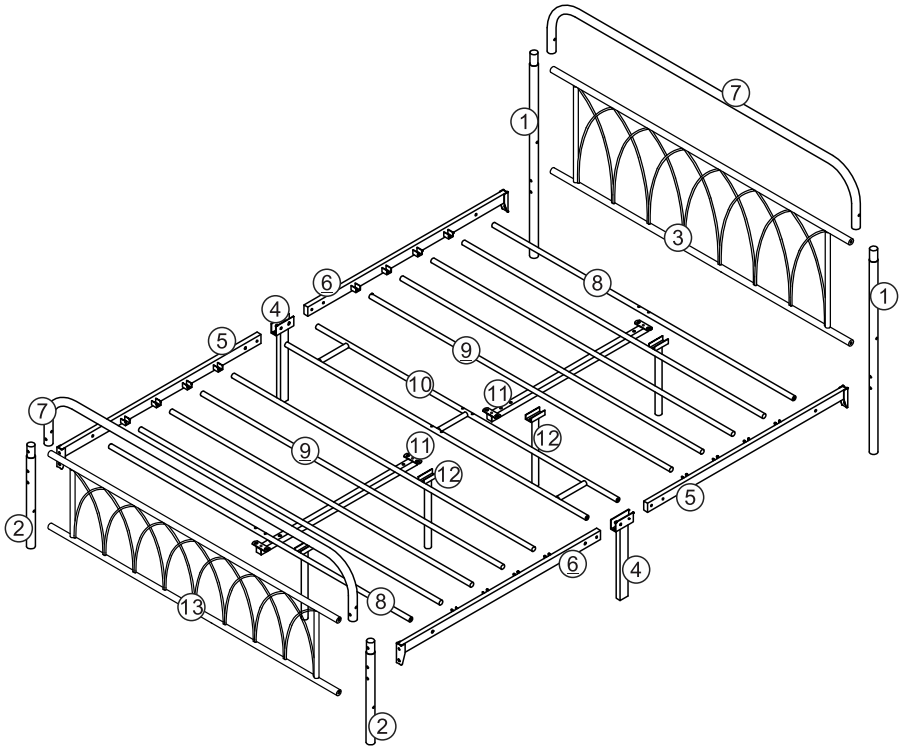

- EN** - Please follow the instruction manuals and use a pad to avoid damage during assembly.
- DE** - Bitte folgen Sie der Anleitung und verwenden Sie eine Unterlage, um Beschädigungen bei der Montage zu vermeiden.
- ES** - Por favor, siga las instrucciones del manual y utilice una cubierta o lona para proteger el producto y el suelo durante la instalación.
- FR** - Suivez les instructions de la notice et utilisez une couverture ou une bâche pour protéger le produit et les sols pendant le montage.
- IT** - Si prega di consultare il manuale illustrativo durante il montaggio e di utilizzare un cuscinetto per evitare possibili danni.

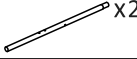

① × 2 	② × 2 	③ × 1 	④ × 2 
⑤ × 2 	⑥ × 2 	⑦ × 2 	⑧ × 2 
⑨ × 8 	⑩ × 1 	⑪ × 2 	⑫ × 4 
⑬ × 1 	Ⓐ × 8 	Ⓑ × 8 	Ⓒ × 20  M6x35mm
Ⓓ × 8  M6x30mm	Ⓔ × 8 	Ⓕ × 20 	Ⓖ × 20  M6
Ⓗ × 8 	Ⓘ × 4  M8	Ⓙ × 1 	Ⓚ × 1 



1

①	 x2	②	 x2	③	 x1	⑦	 x2
⑬	 x1	Ⓑ	 x8	Ⓔ	 x4	Ⓕ	 x12

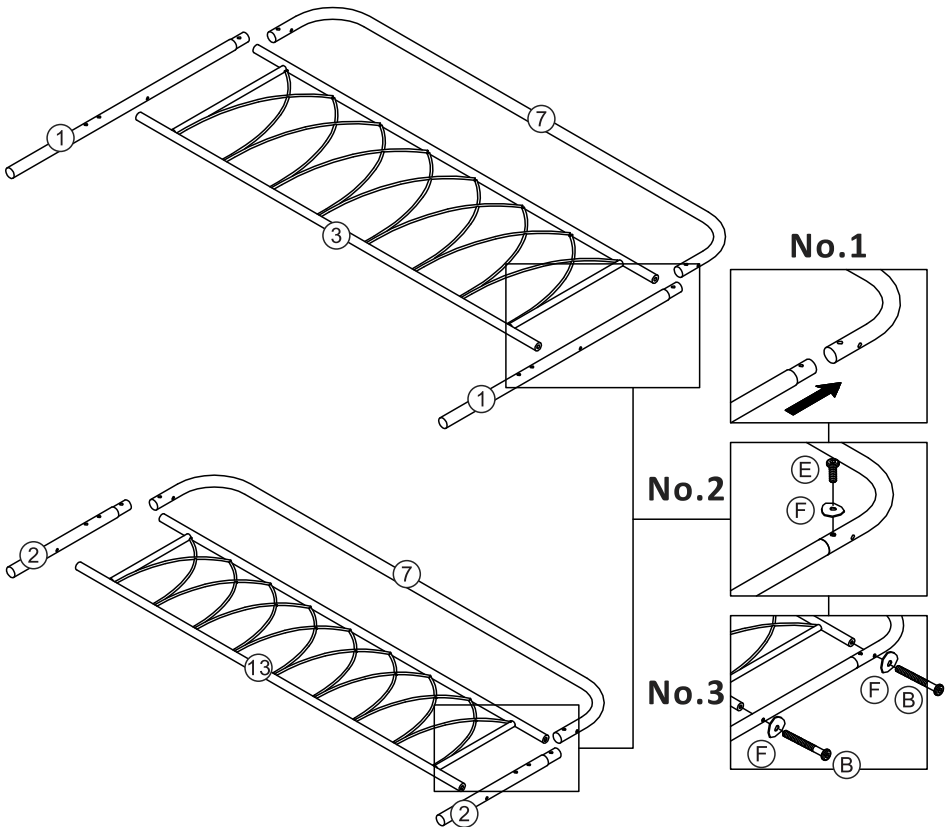

**EN** - During the assembly, please first half-tighten all the screws into the holes. After all the screws are set, fully tighten them.







**DE** - Bitte alle Schrauben leicht von Hand eindrehen, erst nachdem alle eingedreht sind, die Schrauben dann vollständig mit dem Inbusschlüssel festziehen.

**ES** - Durante el montaje, apriete todos los tornillos sólo hasta la mitad. después de insertar todos los tornillos, apriételos completamente.

**FR** - Pendant le montage, il est recommandé de ne serrer les vis qu'à demi. Ne vissez à fond qu'une fois toutes les vis insérées.

**IT** - Durante il montaggio, si prega di stringere tutte le viti solo a metà. Solamente dopo aver inserito tutte le viti, stringerle completamente.

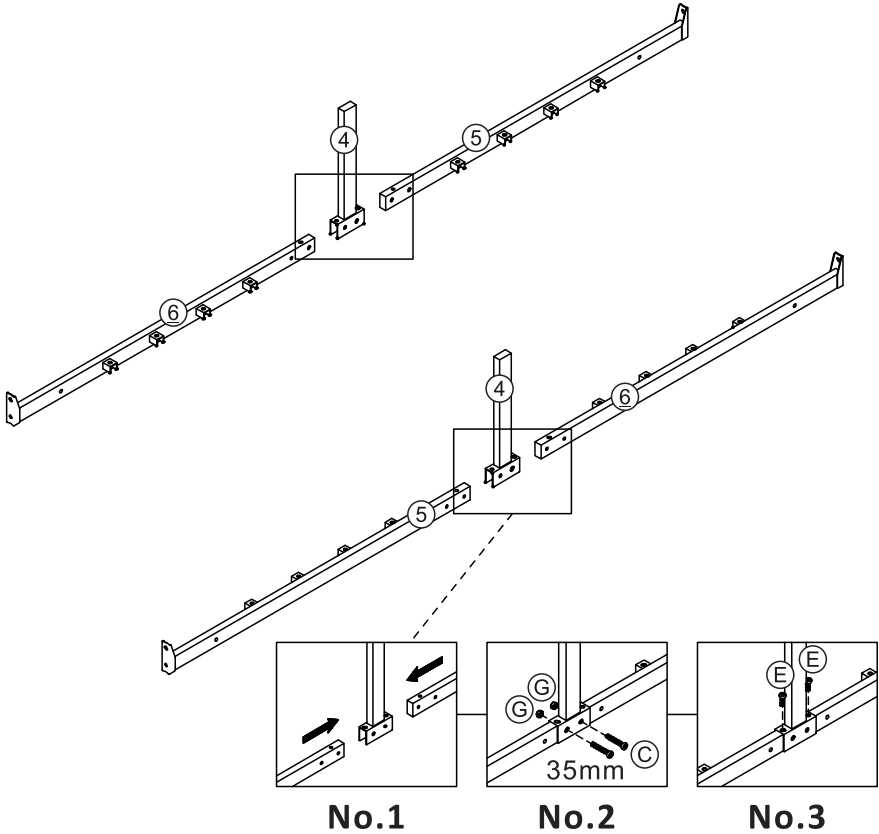

2

④	 x2	⑤	 x2	⑥	 x2	C	 x4
E	 x4	G	 x4				



- EN** - During the assembly, please first half-tighten all the screws into the holes. After all the screws are set, fully tighten them.
- DE** - Bitte alle Schrauben leicht von Hand eindrehen, erst nachdem alle eingedreht sind, die Schrauben dann vollständig mit dem Inbusschlüssel festziehen.
- ES** - Durante el montaje, apriete todos los tornillos sólo hasta la mitad. después de insertar todos los tornillos, apriételes completamente.
- FR** - Pendant le montage, il est recommandé de ne serrer les vis qu'à demi. Ne vissez à fond qu'une fois toutes les vis insérées.
- IT** - Durante il montaggio, si prega di stringere tutte le viti solo a metà. Solamente dopo aver inserito tutte le viti, stringerle completamente.

**3**

(A)		x8
(F)		x8
(I)		x4

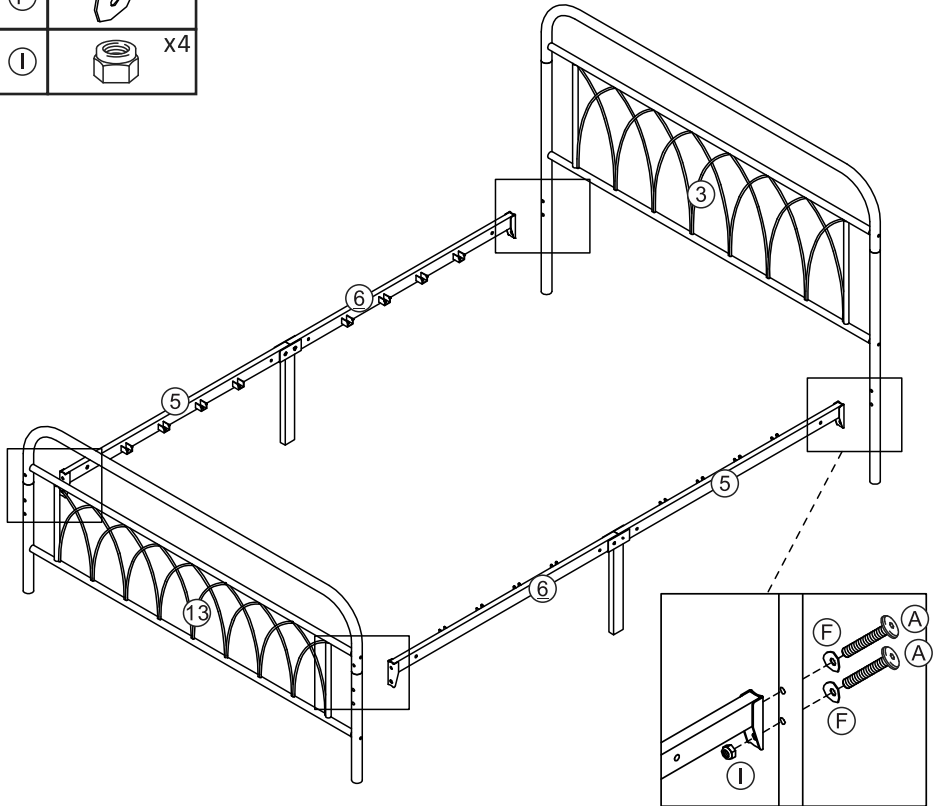

**EN** - During the assembly, please first half-tighten all the screws into the holes. After all the screws are set, fully tighten them.



**DE** - Bitte alle Schrauben leicht von Hand eindrehen, erst nachdem alle eingedreht sind, die Schrauben dann vollständig mit dem Inbusschlüssel festziehen.

**ES** - Durante el montaje, apriete todos los tornillos sólo hasta la mitad. después de insertar todos los tornillos, apriételes completamente.

**FR** - Pendant le montage, il est recommandé de ne serrer les vis qu'à demi. Ne vissez à fond qu'une fois toutes les vis insérées.

**IT** - Durante il montaggio, si prega di stringere tutte le viti solo a metà. Solamente dopo aver inserito tutte le viti, stringerle completamente.

4



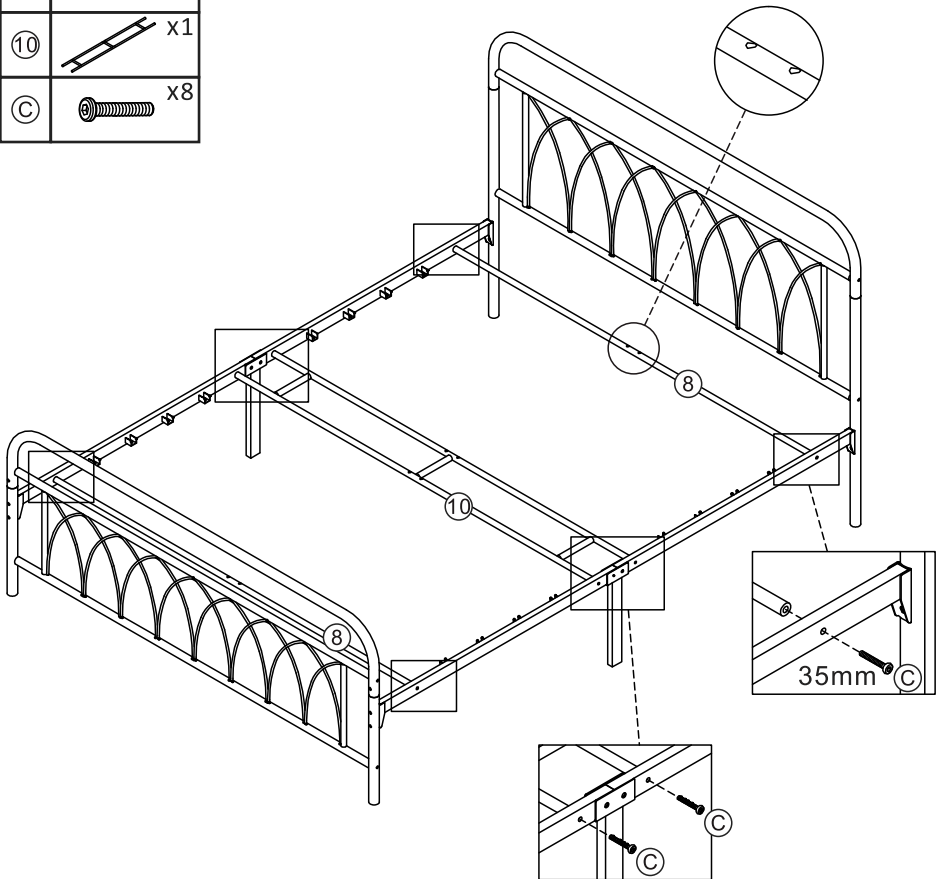



⑧		x2
⑩		x1
Ⓒ		x8



**EN** - Please do not tighten the screw completely at this step.  
**DE** - Bitte ziehen Sie die Schrauben noch nicht fest an.  
**ES** - Por favor, no apriete el tornillo completamente en este paso.  
**FR** - Prière de ne pas visser complètement le boulon à cette étape.  
**IT** - Si prega di non stringere completamente la vite.



**5**

(11)		x2
(12)		x4
(C)		x8
(D)		x8
(H)		x8
(G)		x16

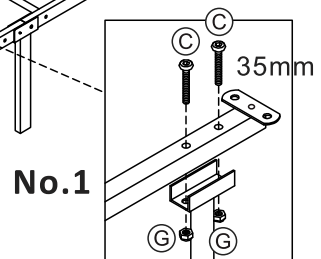
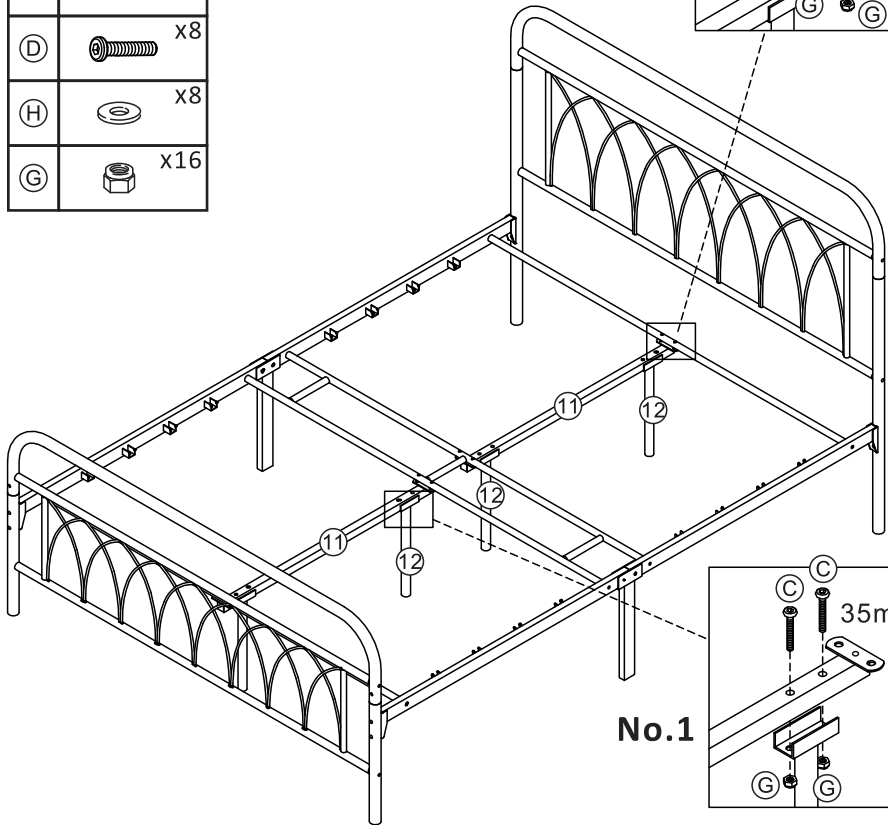
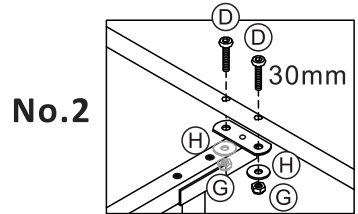

**EN** - During the assembly, please first half-tighten all the screws into the holes. After all the screws are set, fully tighten them.

**DE** - Bitte alle Schrauben leicht von Hand eindrehen, erst nachdem alle eingedreht sind, die Schrauben dann vollständig mit dem Inbusschlüssel festziehen.

**ES** - Durante el montaje, apriete todos los tornillos sólo hasta la mitad. después de insertar todos los tornillos, apriételes completamente.

**FR** - Pendant le montage, il est recommandé de ne serrer les vis qu'à demi. Ne vissez à fond qu'une fois toutes les vis insérées.

**IT** - Durante il montaggio, si prega di stringere tutte le viti solo a metà. Solamente dopo aver inserito tutte le viti, stringerle completamente.

6

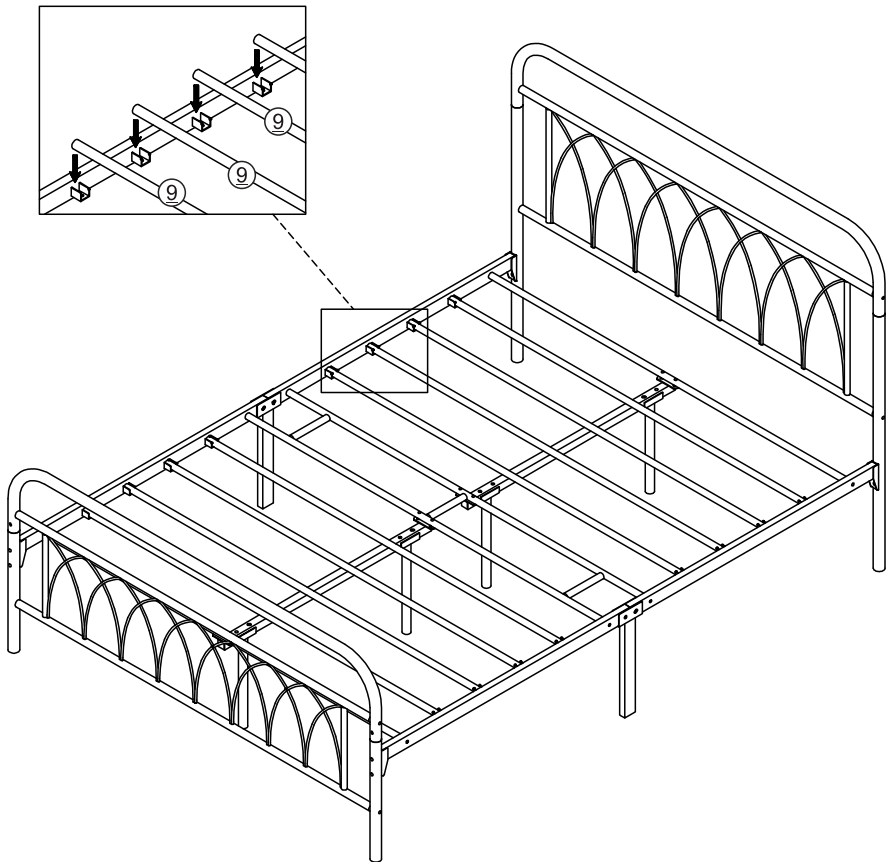

**EN** - Note: Tighten all screws completely after assembly.

**DE** - Hinweis: Ziehen Sie nach der Montage alle Schrauben vollständig an.

**ES** - Nota: Apretar completamente todos los tornillos después de montar.

**FR** - NB : Serrez les vis complètement après l'assemblage.

**IT** - Nota: Stringere completamente tutte le viti solo dopo l'assemblaggio.

EN



If you are not entirely satisfied with your purchase, please feel free to contact us using the following steps:

1. Go to Your Orders.
2. Find your order in the list.
3. Select Problem with order.
4. Choose your topic from list displayed.
5. Select Contact seller.

DE



Sollten Sie mit Ihrem Kauf nicht zufrieden sein, nehmen Sie bitte in folgenden Schritten mit uns Kontakt auf:

1. Gehen Sie auf die Bestellseite
  2. Suchen Sie Ihre Bestellung in der Bestellliste
  3. Schildern Sie das Problem mit der Bestellung
  4. Thema aus der angezeigten Liste auswählen
  5. Kontakt mit dem Verkäufer aufnehmen.
- Hergestellt in PRC für Yahee GmbH  
Importeur: Yahee GmbH  
Höpfigheimer Straße 11.7  
4321 Bietigheim-Bissingen

ES



Si no está totalmente satisfecho con su compra, no dude en ponerse en contacto con nosotros siguiendo las siguientes instrucciones:

1. Vaya a la lista de sus ordenes de compra.
2. Localice su pedido en la lista.
3. Seleccione el problema en el pedido.
4. Elija un tema de la lista que se muestra.
5. Seleccione Contactar con el vendedor.

FR



Si vous n'êtes pas satisfait de votre achat, veuillez nous contacter en procédant comme suit :

1. Allez sur "Vos commandes"
2. Trouvez votre commande dans la liste.
3. Cliquez sur "Signaler un problème"
4. Sélectionnez une catégorie dans la liste déroulante.
5. Cliquez sur "Contactez le vendeur"

IT



Se non siete soddisfatti di questa esperienza dello shopping, non esitate a contattarci per i seguenti passaggi:

1. Vai ai tuoi ordini.
2. Selezionare "l'ordine interessato".
3. Selezionare il problema con l'ordine.
4. Scegli il tuo argomento dalla lista visualizzata.
5. Selezionare "contatta il venditore".

**EN** - You can also download the electronic Installation Manual from the Product guides and documents section of the advertising page.

**DE** - Das elektronische Installationshandbuch können Sie auch im Bereich Produktführungen und Dokumente der Werbeseite herunterladen.

**ES** - También puede descargar el Manual de instalación electrónica de la Guía del producto y la Sección de documentación de la página de anuncios.

**FR** - Vous pouvez également télécharger le manuel d'installation électronique à partir de la section Guide produit et documentation de la page publicitaire.

**IT** - È inoltre possibile scaricare il manuale di installazione elettronico dalla guida del prodotto e dai documenti nella pagina pubblicitaria.