

C1508B

No:	Fittings:	Qty:
A		1
B		1
C		1
D		8
E		8
F		4
G	 4mm	1

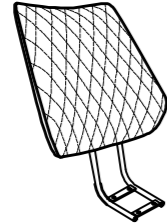

①

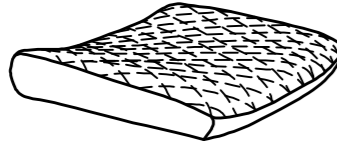
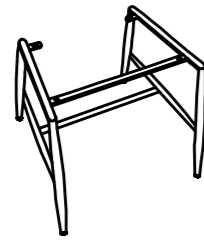
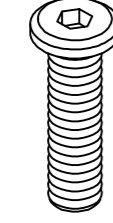
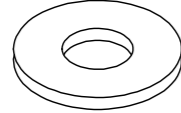
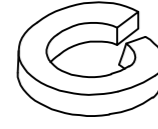
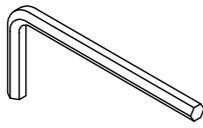
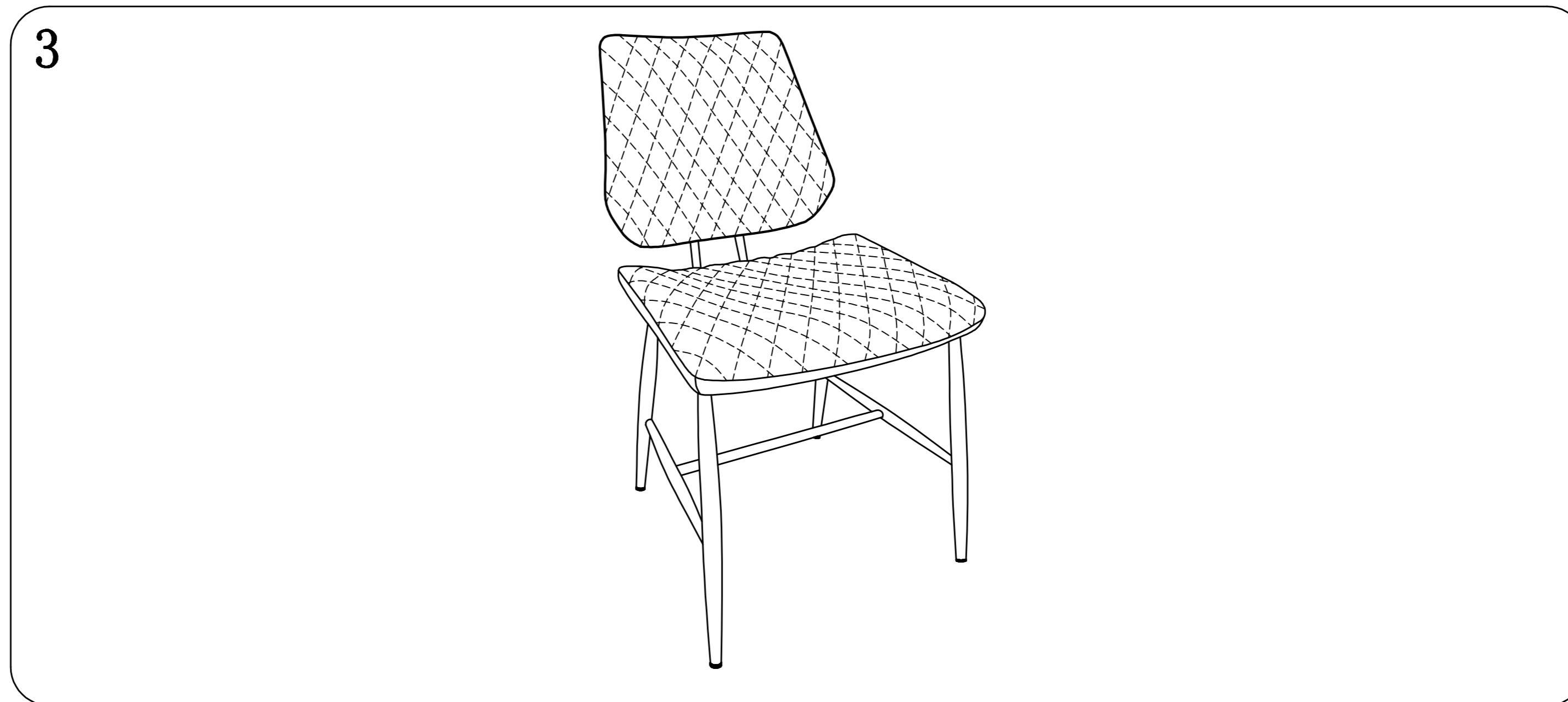
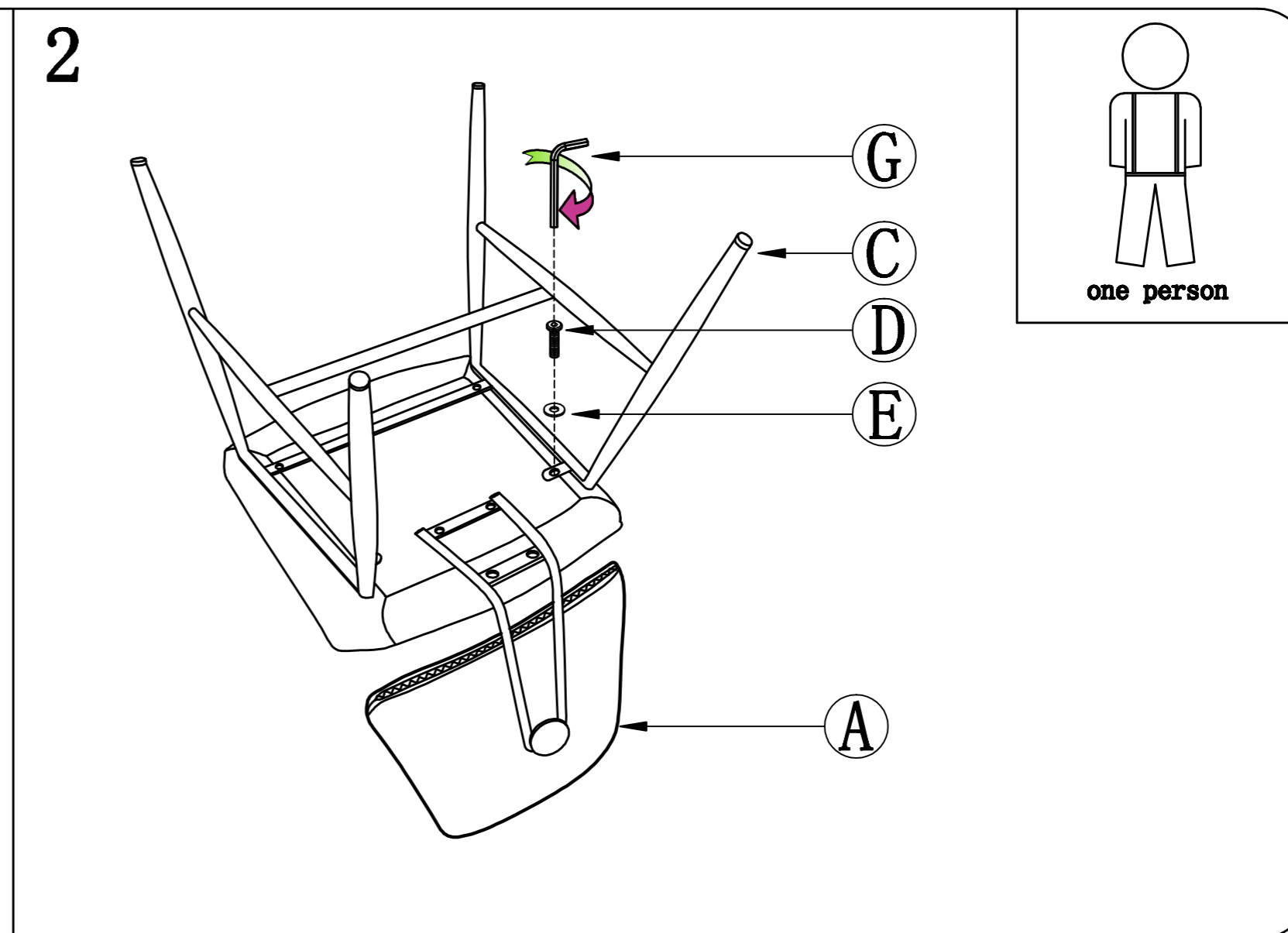
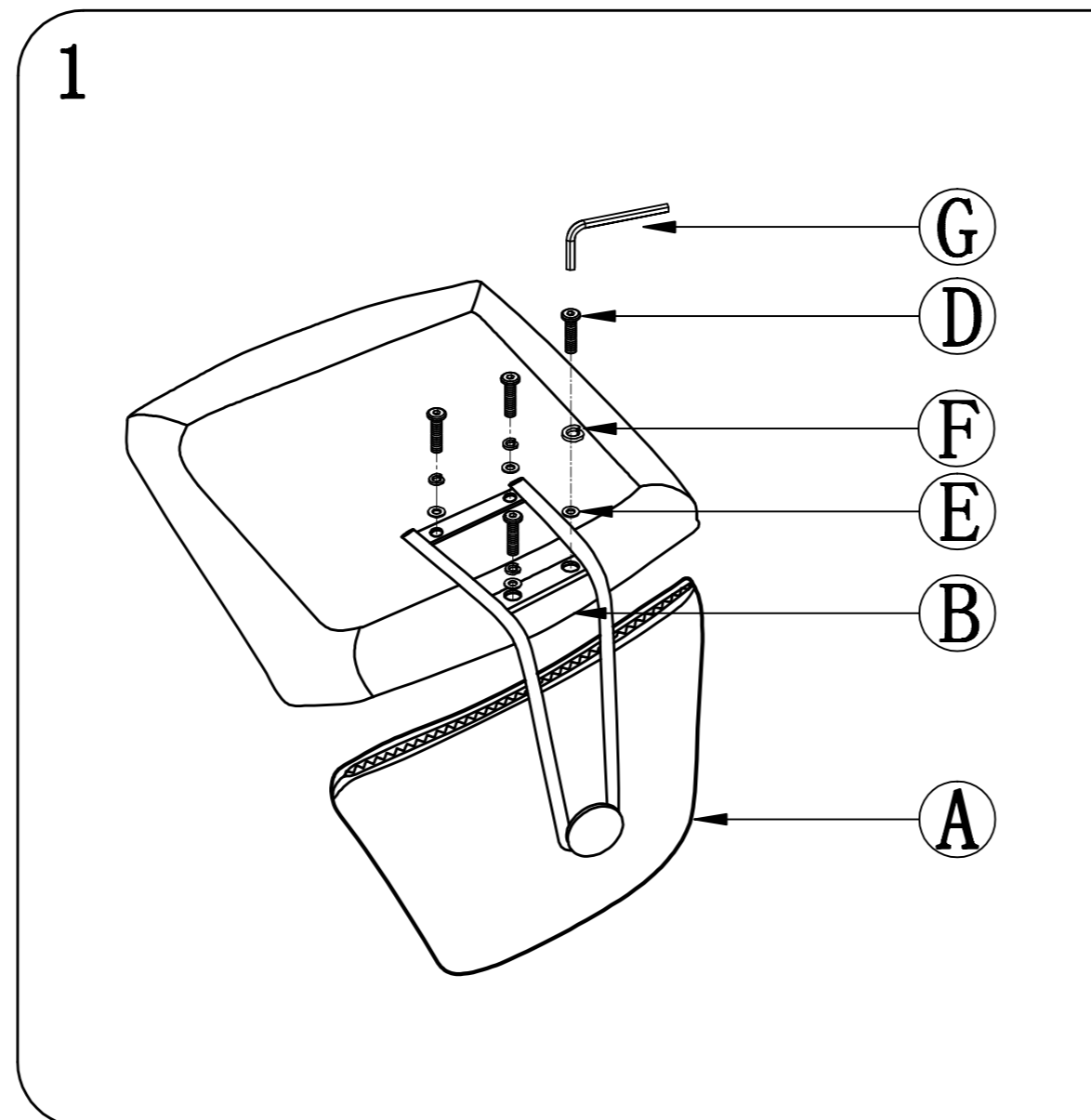
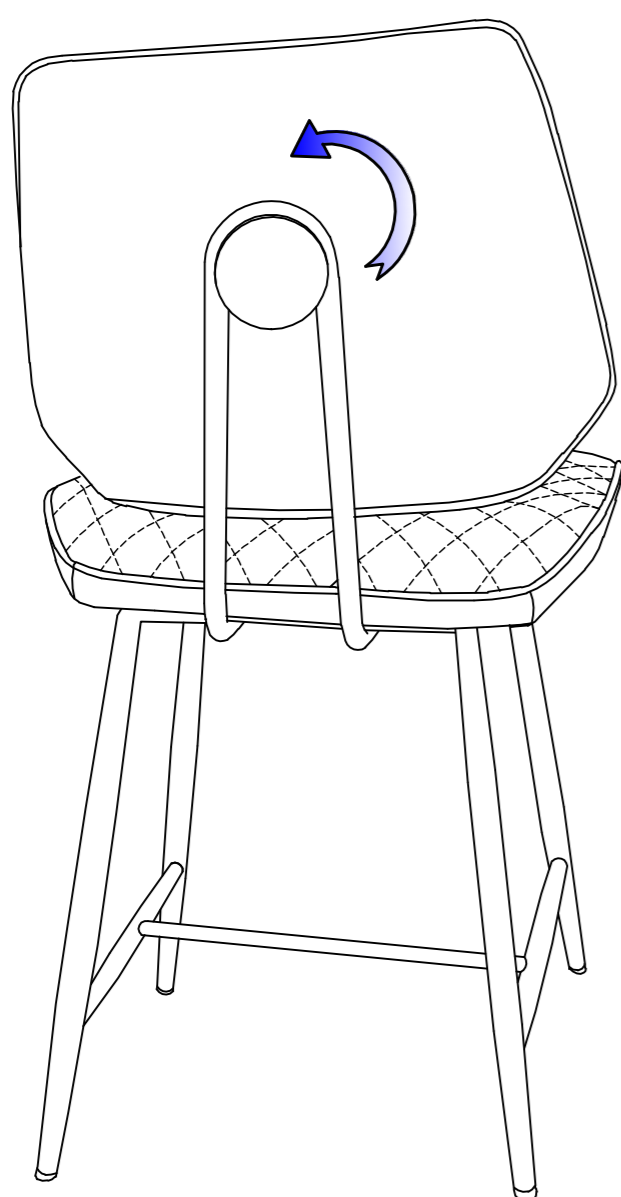

②

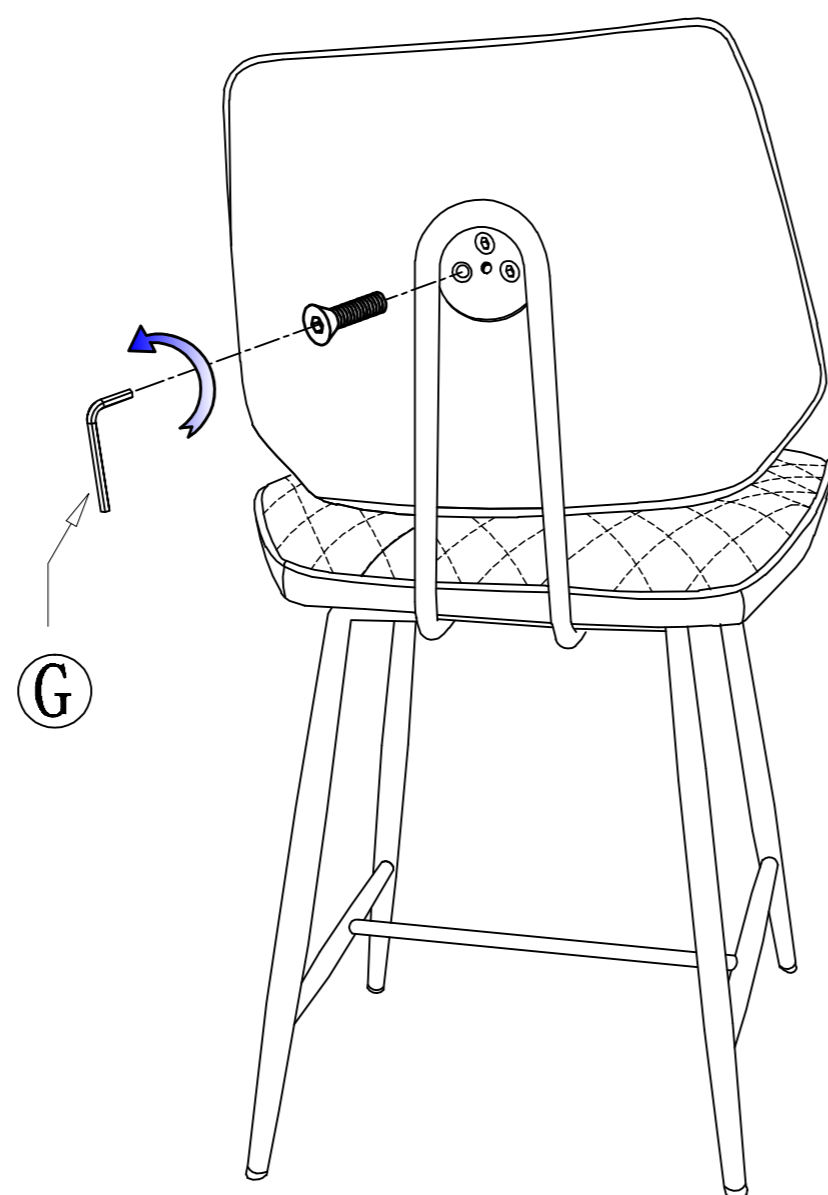

③

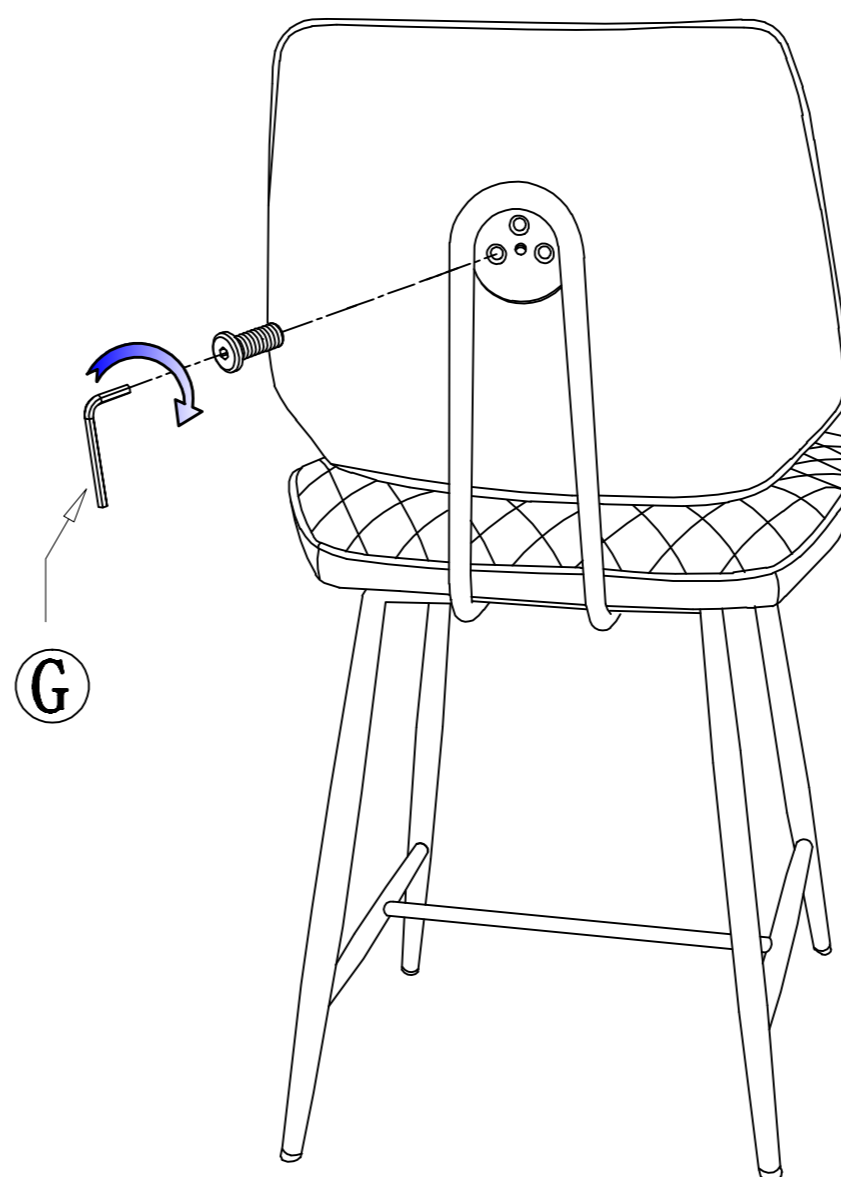

④

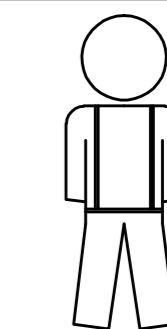
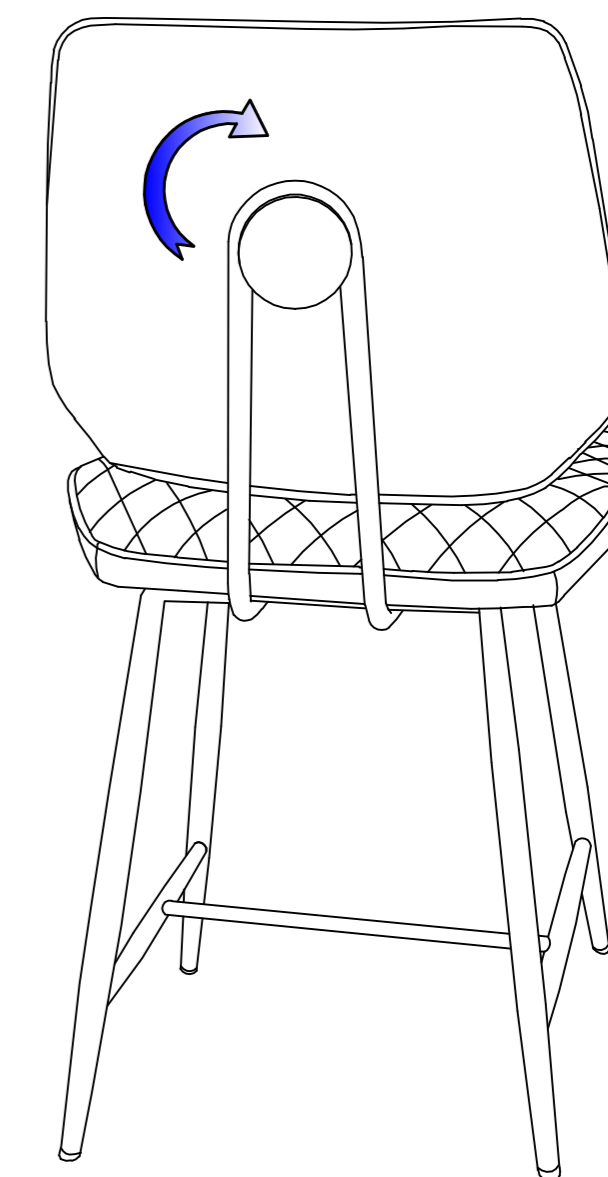

one person

### How to adjust the back rest

1. Turn the metal disc anti clockwise to remove.
2. Using the allen key, loosen the bolts.
3. Straighten the back rest and retighten the bolts.
4. Replace the metal disc, turning it clockwise to secure.