



SENNHEISER











ACCENTUM

Model: ACAEBT



EN Quick Guide
DE Kurzanleitung
FR Guide rapide
ES Instrucciones resumidas
PT Guia rápidos
NL Beknopte handleiding
IT Guida rapida
DA Kort vejledning
SV Snabbguide
FI Pikaohje
EL Σύντομες οδηγίες
PL Krótka instrukcja obsługi
TR Kısa Kılavuz
RU Краткая инструкция
JA クイックガイド

ZH-HANS 快速指南
ZH-HANT 快速指南
KO 빠른 안내서
ID Panduan ringkas
ET Lühijuhend
LV Īsā instrukcija
LT Trumpoji naudojimo instrukcija
CZ Stručný návod
SK Stručný návod
HU Rövid útmutató
RO Instrucțiuni succinte
BG Кратко ръководство
SL Kratka navodila
HR Kratke upute

-  Charging 3
-  Power on / Power off 4
-  Pairing 5
-  Music control 6
-  Call control 7
-  Active Noise Cancellation 8
-  Transparency Mode 9
-  Voice assistant 10
-  Package includes 11
-  Troubleshooting 12

1.

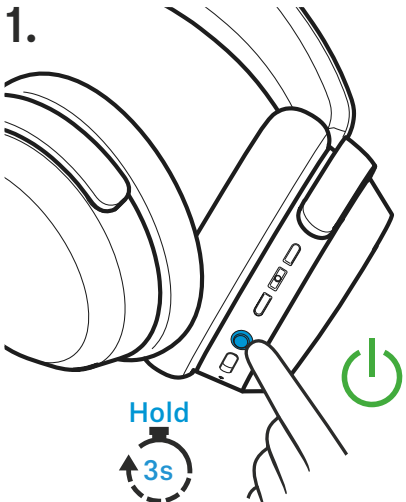

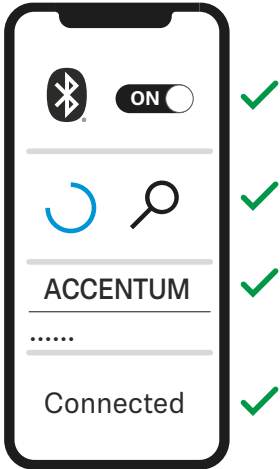

Hold
3s

2.



3.

 **Smart Control**

GET IT ON
Google Play



Download on the
App Store





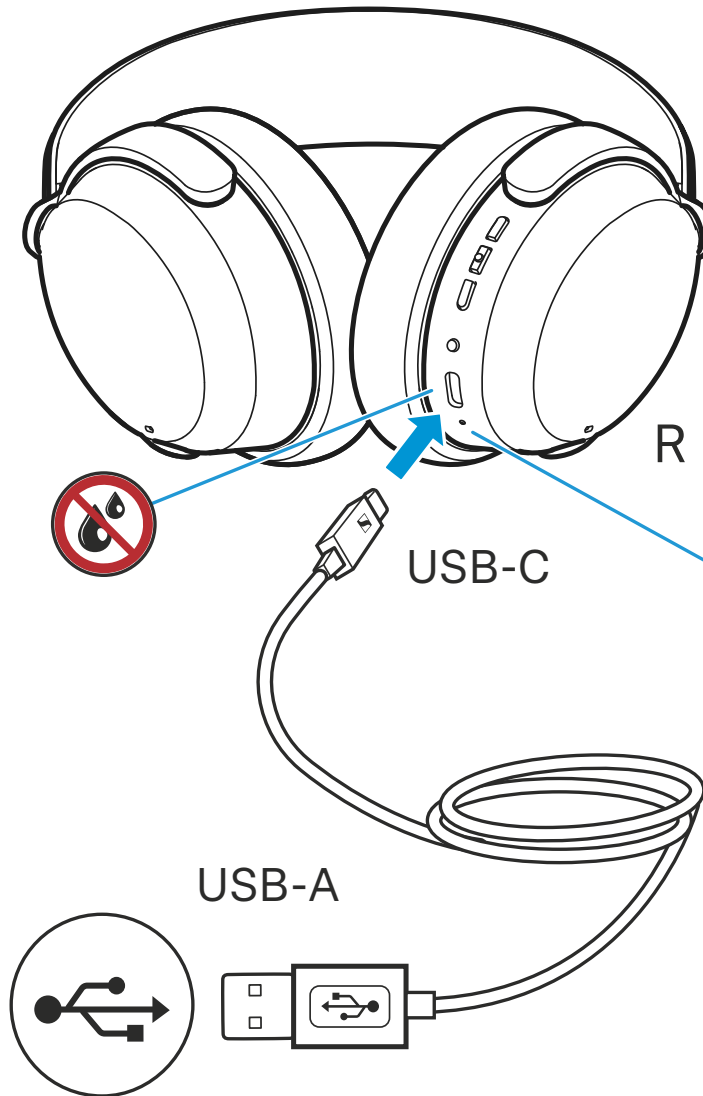

Charging

- DE Laden
- FR Charger
- ES Cargar
- PT Carregar
- NL Opladen
- IT Caricare
- DA Opladning
- SV Laddning
- FI Lataaminen
- EL Φόρτιση
- PL Ładowanie
- TR Şarj etme
- RU Зарядка
- JA 充電
- ZH-HANS 充电
- ZH-HANT 充電
- KO 충전
- ID Mengisi daya
- ET Laadimine
- LV Uzlādēšana
- LT Įkrovimas
- CZ Nabíjení
- SK Nabíjanie
- HU Az akkumulátor feltöltése
- RO Încărcarea
- BG Зареждане
- SL Polnjenje
- HR Punjenje





 10 min up to 5 hrs

 3 hrs up to 50 hrs

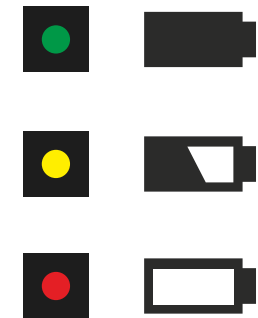



SENNHEISER

Power on / Power off

DE	Einschalten/Ausschalten
FR	Allumer / éteindre
ES	Encender / Apagar
PT	Ligar/desligar
NL	Inschakelen/uitschakelen
IT	Accendere/Spegnere
DA	Tænd/sluk
SV	Sätta på/stänga av
FI	Virran kytkeminen ja katkaiseminen
EL	Ενεργοποίηση / απενεργοποίηση
PL	Włączenie / wyłączenie
TR	Açma/Kapatma
RU	Включение/выключение
JA	スイッチのオン/オフ
ZH-HANS	接通/关闭
ZH-HANT	接通 / 關閉
KO	켜기/끄기
ID	Mengaktifkan/menonaktifkan
ET	Sisse-/väljalülitamine
LV	Ieslēgšana/izslēgšana
LT	Ijungimas ir išjungimas
CZ	Zapnutí/vypnutí
SK	Zapnutie/vypnutie
HU	Bekapcsolás/kikapcsolás
RO	Pornirea/oprirea
BG	Включване/Изключване
SL	Vklop/izklop
HR	Uključivanje/isključivanje

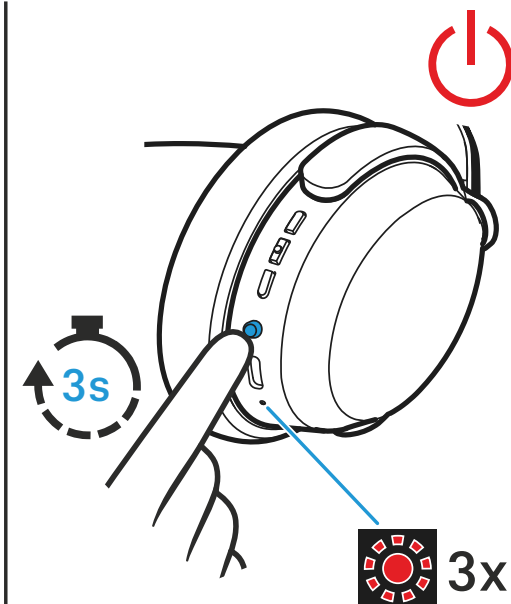
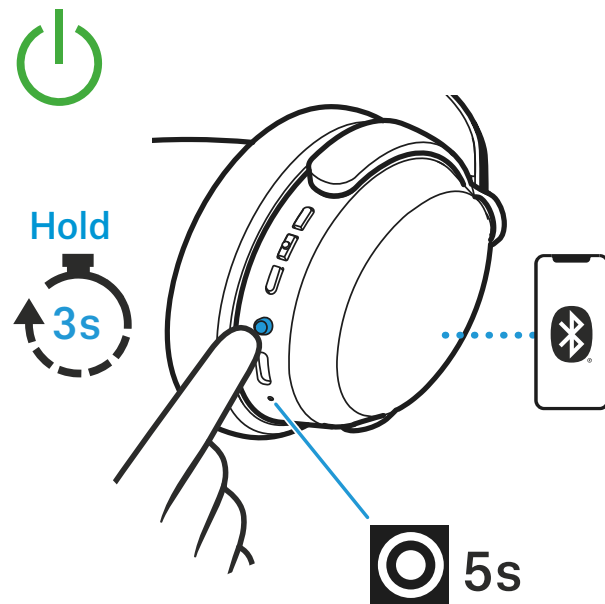



Pairing

- DE Koppeln
- FR Appairer
- ES Sincronizar
- PT Emparelhar
- NL Koppelen
- IT Accoppiare
- DA Parring
- SV Parkoppla
- FI Pariliitoksen muodostaminen
- EL Ζεύξη
- PL Parowanie
- TR Eşleşirme
- RU Сопряжение
- JA 連結
- ZH-HANS 配对
- ZH-HANT 配對
- KO 페어링
- ID Menyandingkan
- ET Sidumine
- LV Pieslēgšana
- LT Susiejimas
- CZ Připojení
- SK Spárovanie
- HU Párosítás
- RO Cuplarea
- BG Сдвояване
- SL Seznanjanje
- HR Uparivanje

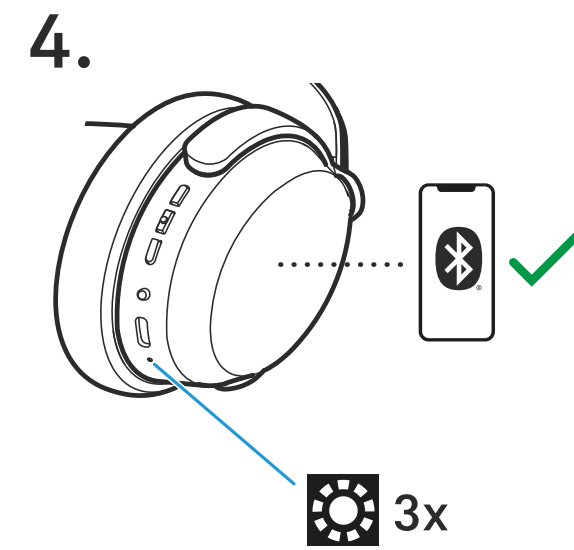
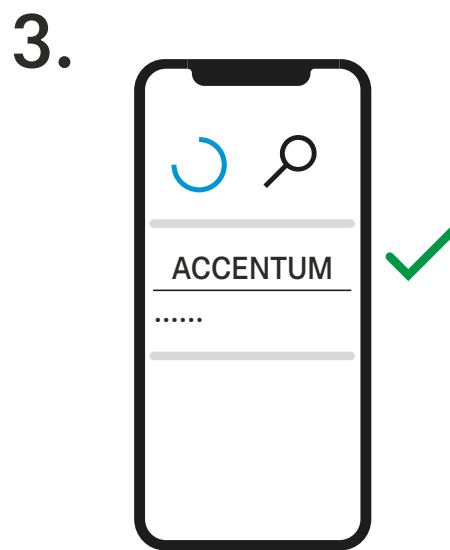
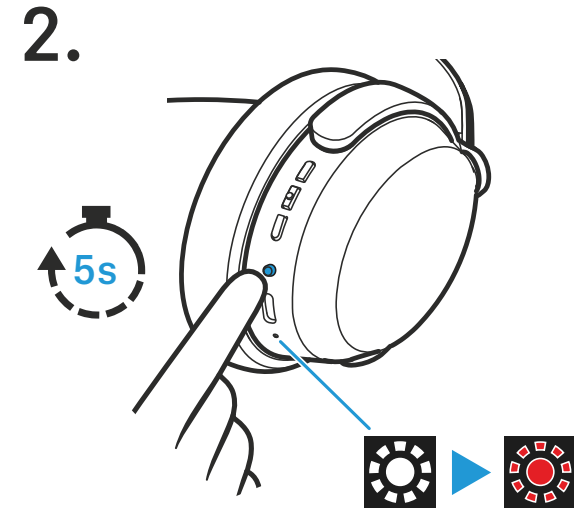
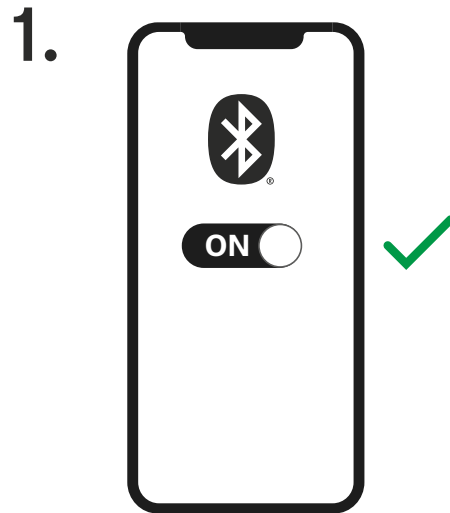



Music control

- DE Musiksteuerung
- FR Contrôle de la musique
- ES Control de música
- PT Controlo/Controle da música
- NL Muziekbediening
- IT Gestione della musica
- DA Musikstyring
- SV Musikstyrning
- FI Musiikin toiston ohjaus
- EL Χειρισμός αναπαραγωγής μουσικής
- PL Sterowanie muzyką
- TR Müzik kumandası
- RU Управление воспроизведением музыки
- JA 音楽制御
- ZH-HANS 音乐控制器
- ZH-HANT 音樂控制器
- KO 음악 제어
- ID Pengaturan musik
- ET Muusika juhtimine
- LV Mūzikas atskaņošanas vadīšana
- LT Muzikos valdymas
- CZ Ovládání hudby
- SK Ovládanie hudby
- HU Zenevezérlés
- RO Comandă muzică
- BG Управление на музика
- SL Nadzor glasbe
- HR Upravljanje glazbom

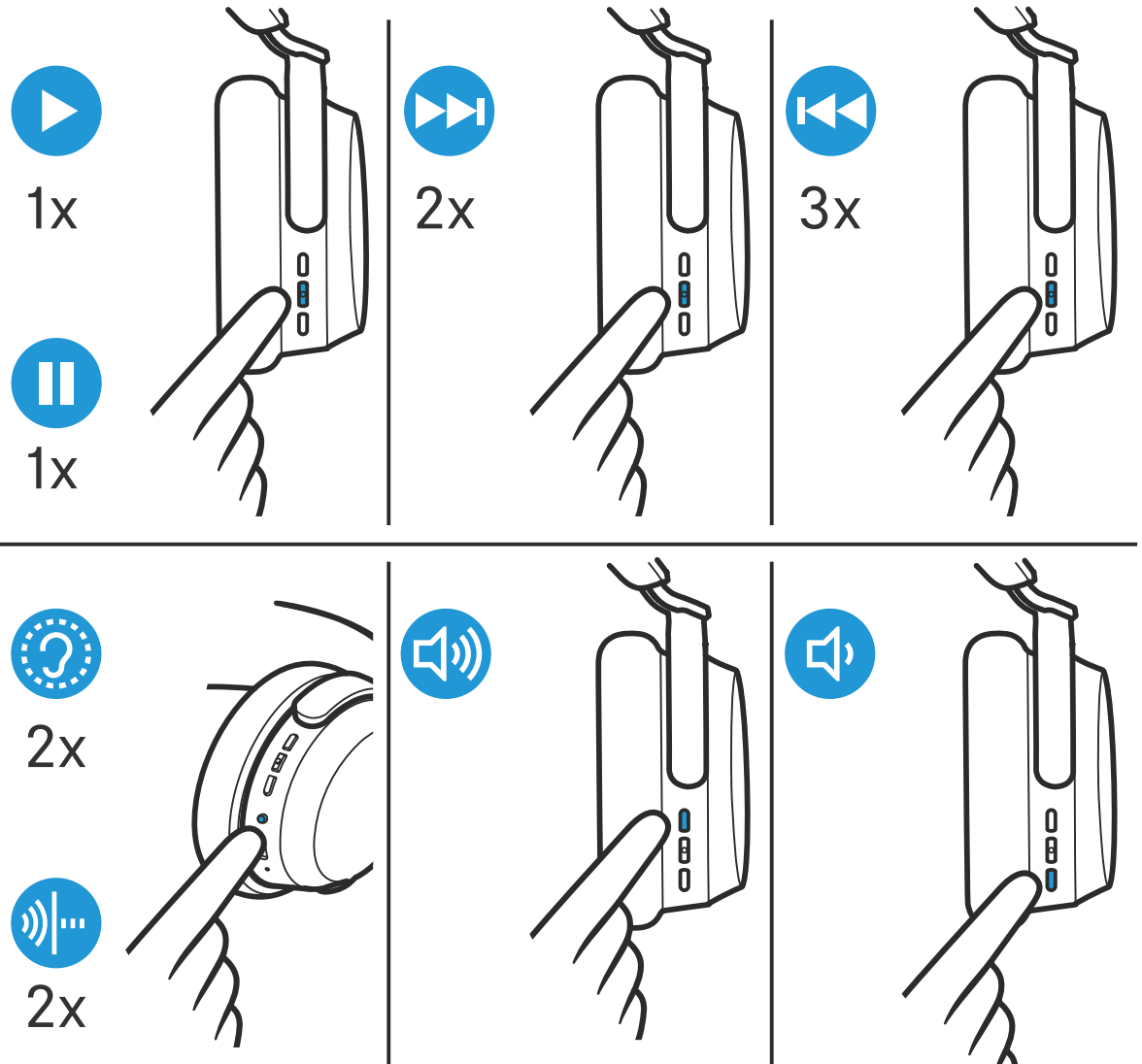



Call control

- DE Anrufsteuerung
- FR Contrôle des appels
- ES Control de llamadas
- PT Controlo/Controle de chamadas
- NL Belbesturing
- IT Gestione delle chiamate
- DA Opkaldsstyring
- SV Samtalsstyrning
- FI Puhelujen ohjaus
- EL Χειρισμό κλήσεων
- PL Sterowanie rozmowami telefonicznymi
- TR Çağrı kontrolü
- RU Управление вызовами
- JA 電話制御
- ZH-HANS 来电控制器
- ZH-HANT 來電控制器
- KO 통화 제어
- ID Pengaturan panggilan
- ET Kõnede juhtimine
- LV Zvanu vadīšana
- LT Skambučių valdymas
- CZ Ovládání hovorů
- SK Ovládanie hovoru
- HU Hívásvezérlés
- RO Comandă apeluri
- BG Управление на обаждания
- SL Nadzor klicev
- HR Upravljanje pozivima

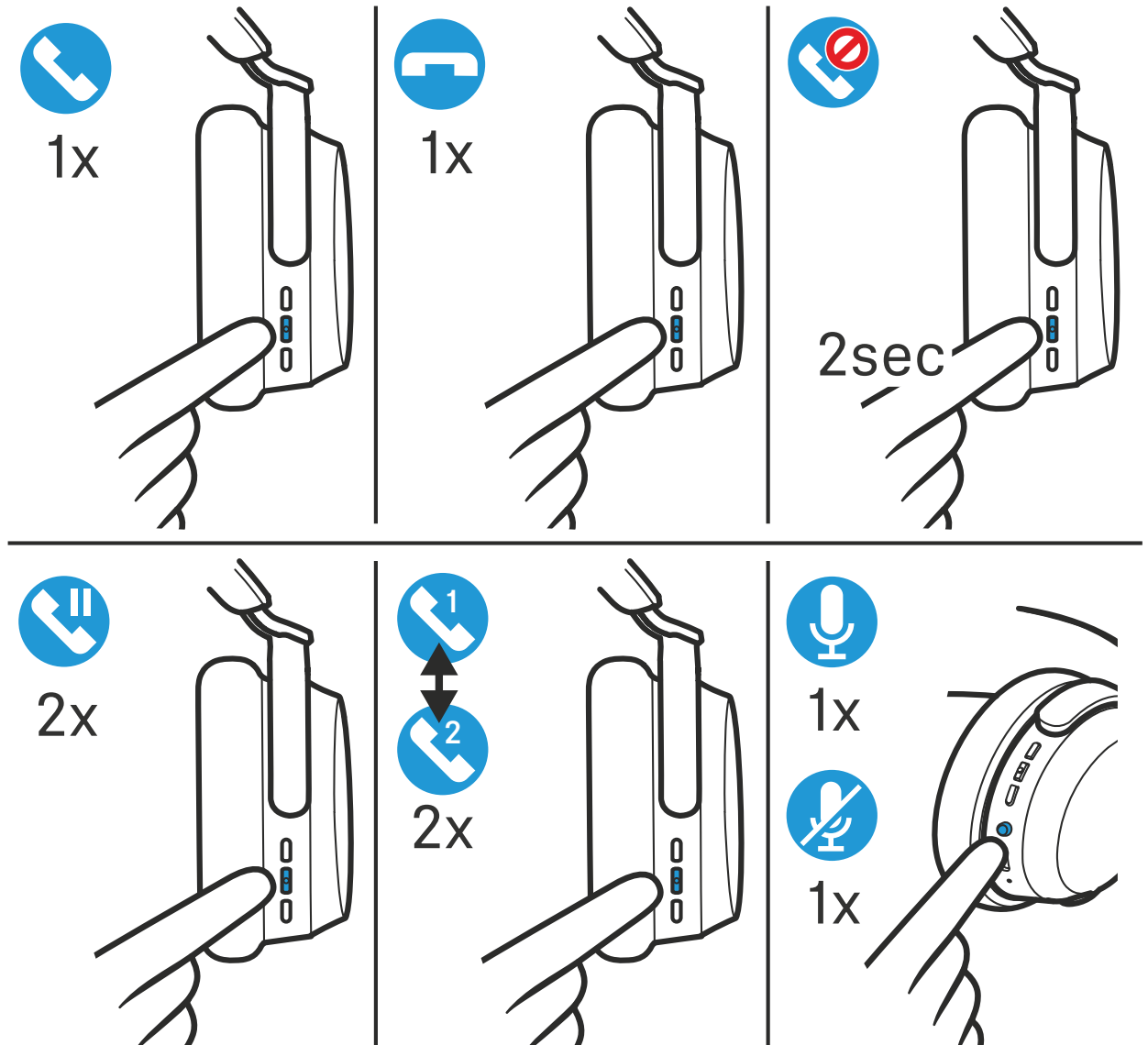



Active Noise Cancellation

DE	Aktive Geräuschunterdrückung
FR	Annulation active du bruit
ES	Atenuación activa del ruido
PT	Controlo/Controle ativo de ruído
NL	Actieve ruisonderdrukking
IT	Soppressione attiva dei rumori
DA	Aktiv støjundertrykkelse
SV	Aktiv brusreducering
FI	Aktiivinen melunvaimennus
EL	Ενεργή καταστολή θορύβου
PL	Aktywne tłumienie hałasu
TR	Etkin Gürültü Bastırma
RU	Система активного шумоподавления
JA	アクティブノイズキャンセリング
ZH-HANS	主动降噪
ZH-HANT	主動降噪
KO	능동 소음 억제
ID	Peredaman kebisingan aktif
ET	Aktiivne mürasummutus
LV	Aktīvā trokšņu slāpēšana
LT	Aktyvusis triukšmo slopintuvas
CZ	Aktivní potlačení šumu
SK	Aktívne potlačenie šumu
HU	Aktív zajszűrés
RO	Funcția activă de blocare a zgomotelor
BG	Активно шумозаглушаване
SL	Aktivna zadušitev zvoka
HR	Aktivno suzbijanje buke

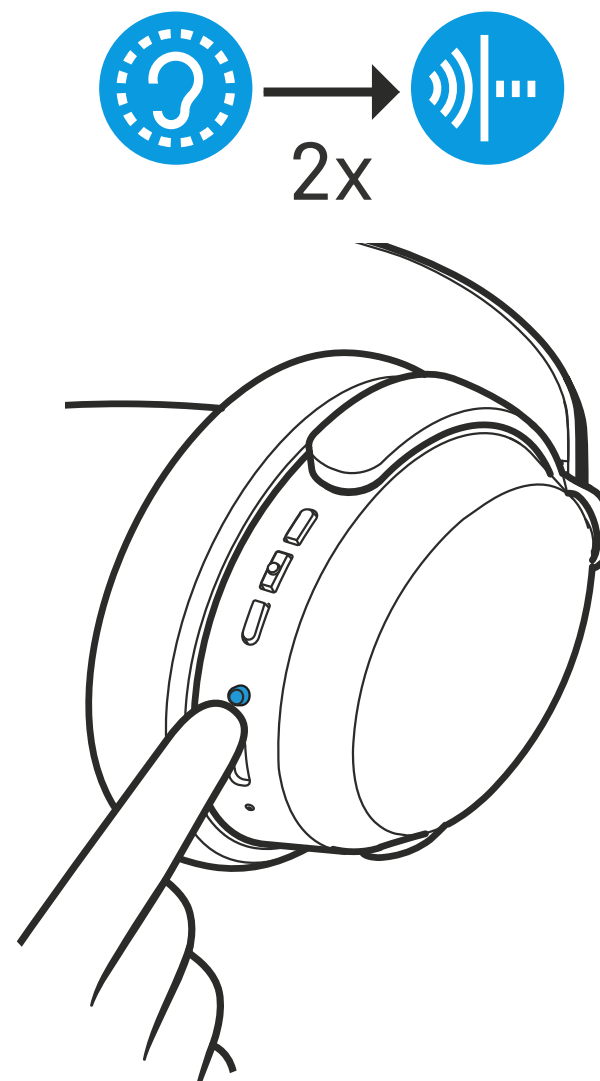



Transparency Mode

DE	Hören von Umgebungsgeräuschen
FR	Écouter les bruits ambiants
ES	Escuchar el ruido ambiental
PT	Escutar ruídos externos
NL	Horen van omgevingsgeluiden
IT	Ascolto di rumori ambientali
DA	Lyd fra omgivelserstøj
SV	Lyssna på bakgrundsljud
FI	Ympäristön äänien kuuluuus
EL	Ακρόαση θορύβων περιβάλλοντος
PL	Słyszenie dźwięków z otoczenia
TR	Çevre seslerini dinleyin
RU	Пропускание шумов окружающей среды
JA	周辺ノイズを聞きます
ZH-HANS	环境噪音控制
ZH-HANT	控制環境噪音
KO	주변 소리 듣기
ID	Mendengarkan suara di sekitar
ET	Keskkonnamüra kuulmine
LV	Apkārtējā trokšņa dzirdamība
LT	Aplinkos triukšmo klausymasis
CZ	Poslech okolních zvuků
SK	Počúvanie okolitých zvukov
HU	Környezeti zaj vagy beszélgetés hallgatásának beállítása
RO	Auzirea zgomotelor ambiante
BG	Чуване на околния шум
SL	Poslušanje zvokov iz okolice
HR	Slušanje okolinske buke

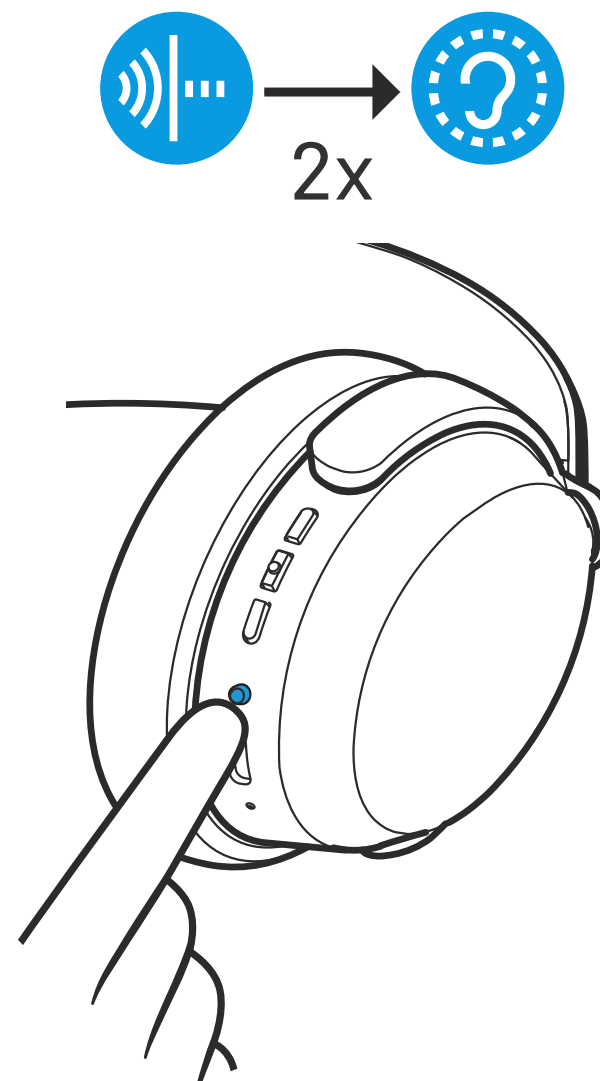



Voice assistant

- DE Sprachassistent
- FR Assistant vocal
- ES Asistente personal
- PT Assistente de voz
- NL Spraakassistent
- IT Assistente vocale
- DA Taleassistent
- SV Röstassistent
- FI Puheavustaja
- EL Φωνητικός βοηθός
- PL Asystent głosowy
- TR Sesli asistan
- RU Голосовой помощник
- JA 言語アシスト
- ZH-HANS 语音助手
- ZH-HANT 語音助手
- KO 음성 어시스턴트
- ID Bantuan bahasa
- ET Häälassistent
- LV Balss asistents
- LT Kalbos pagalbiklis
- CZ Průvodce výběrem jazyků
- SK Hlasový asistent
- HU Beszédszisztens
- RO Asistent de limbă
- BG Езиков асистент
- SL Pomocnik za govor
- HR Govorni asistent

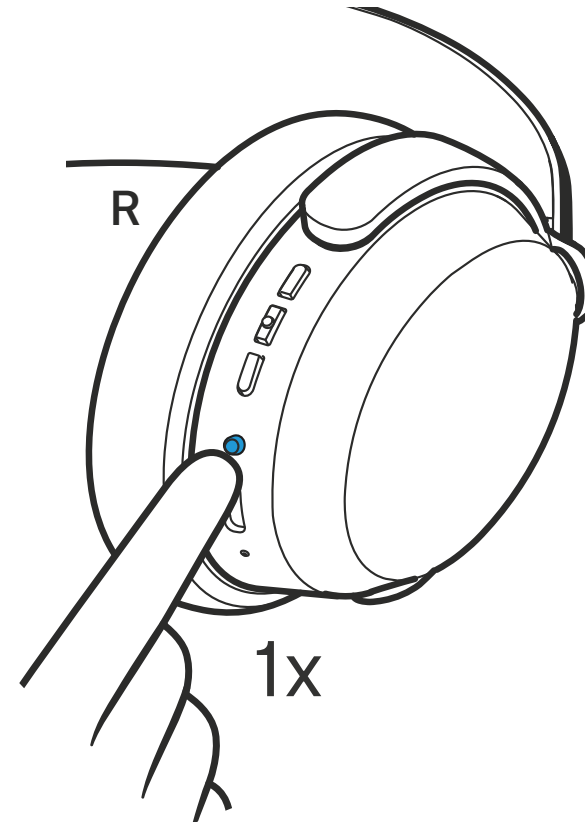

Siri, Google Assistant, ...



Package includes

- DE Lieferumfang
- FR Contenu
- ES Volumen de suministro
- PT Material fornecido
- NL Omvang levering
- IT In dotazione
- DA Leveringsomfang
- SV Leveransomfattning
- FI Toimitussisältö
- EL Περιεχόμενα συσκευασίας
- PL Zakres dostawy
- TR Teslimat kapsamı
- RU Комплект поставки
- JA 同梱されているもの
- ZH-HANS 包装内含
- ZH-HANT 包裝包括
- KO 구성품
- ID Isi kemasan
- ET Tarnekomplekt
- LV Komplektācija
- LT Tiekiamas komplektas
- CZ Obsah dodávky
- SK Rozsah dodávky
- HU Szállított tartozékok
- RO Conținutul pachetului de livrare
- BG Обем на доставката
- SL Obseg dobave
- HR Opseg isporuke

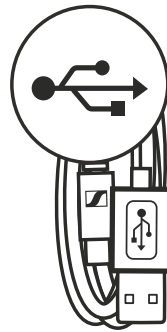

Quick
Guide

Safety
Guide

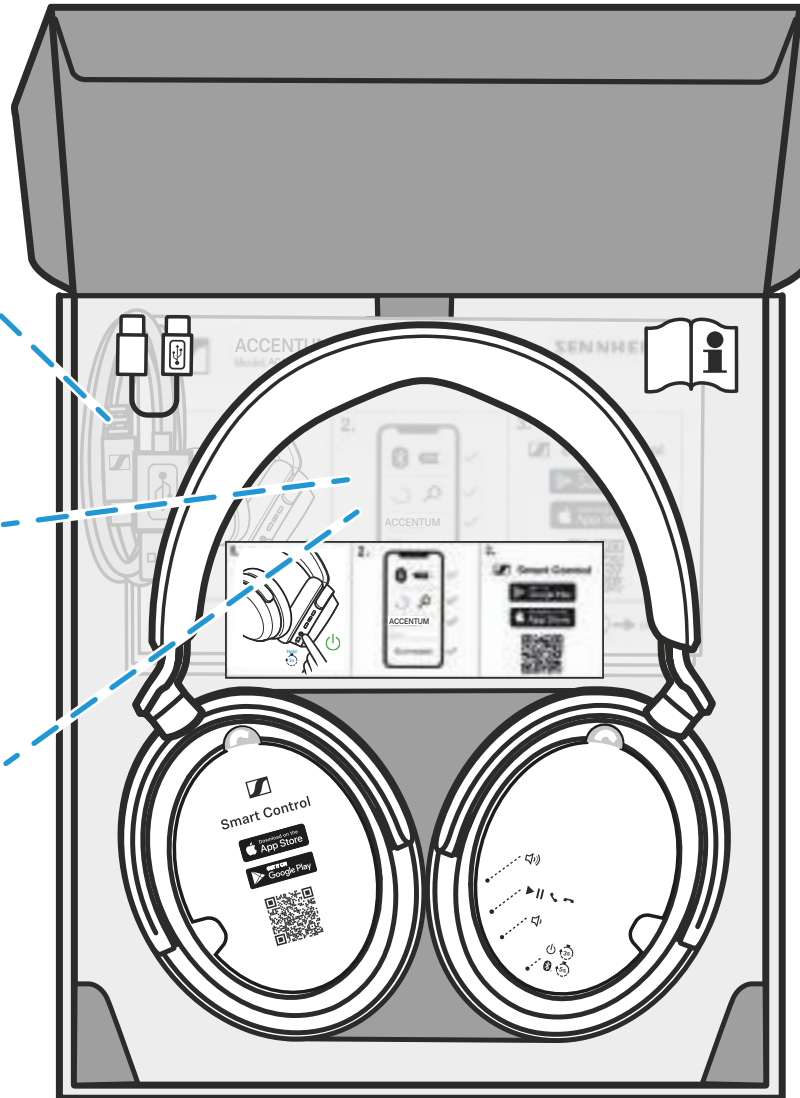

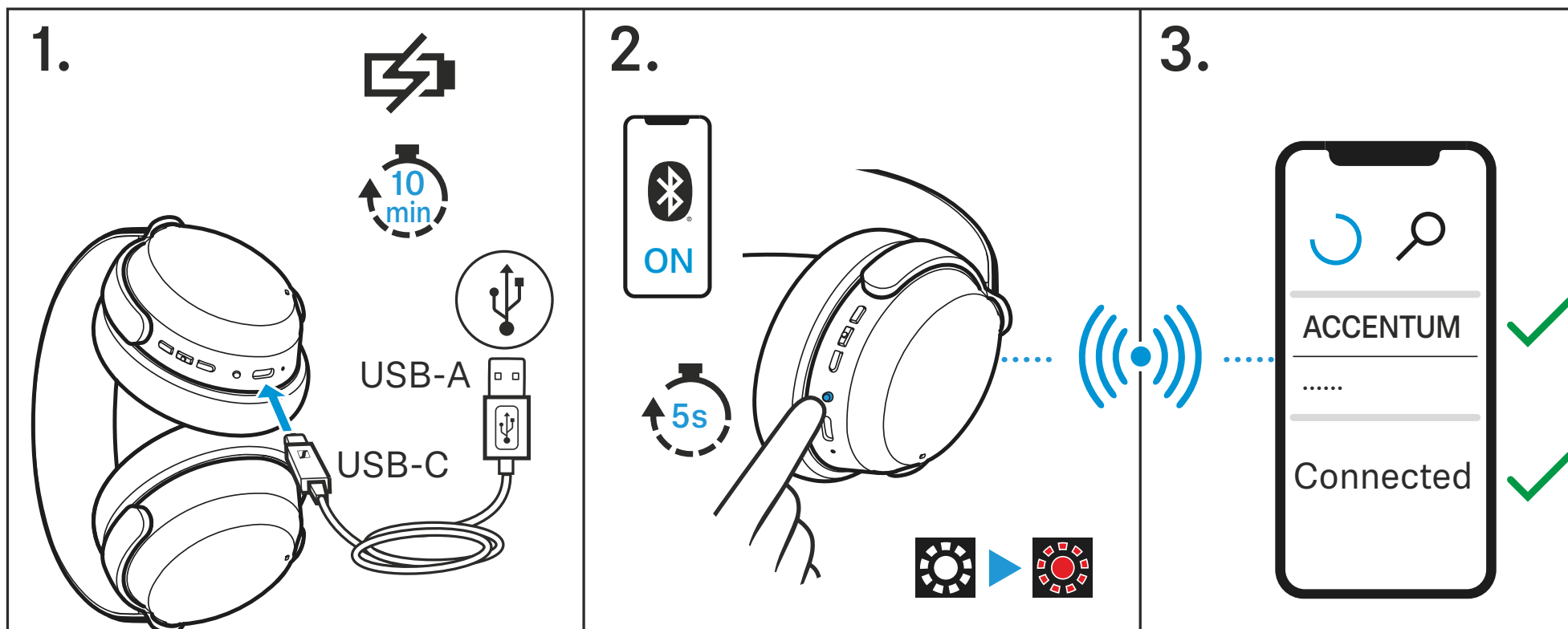

Sonova Consumer Hearing GmbH
 Am Labor 1, 30900 Wedemark, Germany
www.sennheiser-hearing.com
 Publ. 12/23, 596681/A02

Manual and support
www.sennheiser-hearing.com/download