



switch



on



your



mood

Table of Content

Introduction	4
Get to know Moodo	6
Control Moodo with the Moodo mobile app	8
Moodo Setup process	10
App main features	14
Manual control	16
Smart-home control	17
Tech Specs	18
FAQ	20





the smart-home fragrance box

MOODO® is an innovative smart-home fragrance device, designed to help you create your own unique ambiance instantly, using a smartphone app or voice control.

MOODO lets you take the finest fragrances, mix and match them, seamlessly shuffle between them, innovate and invent your own signature scent.



To use your Moodo you need:

- A Moodo Device
- Moodo Fragrance Capsules
- iPhone (from iOS 9) or Android smartphone (from Android 5)
- Access to a wireless network
- Source of electric power (unless equipped with battery)

Get to know moodo

With four separately-controlled fans, you can release a different amount of scent from each capsule.

This patented design enables Moodo to diffuse endless number of scent combinations.

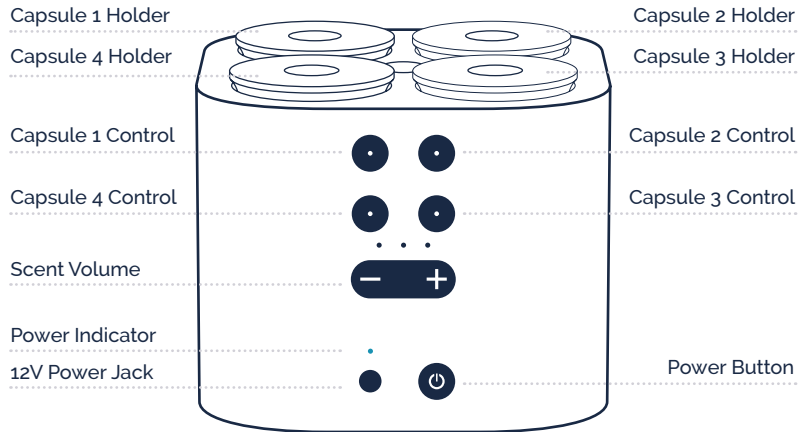

Also supplied in the box:
90-230V power adapter suitable for USA or Europe electric outlet

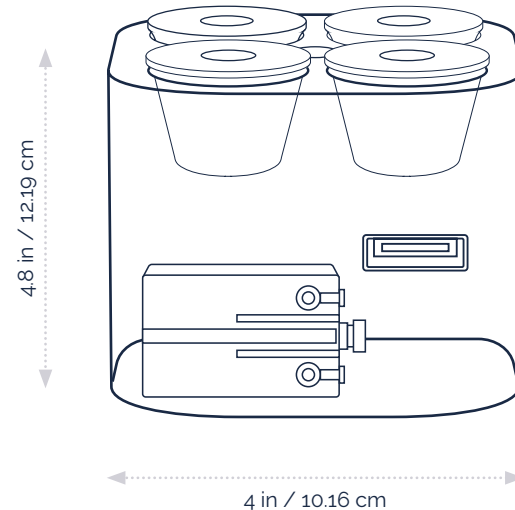

Control Moodo with the Moodo mobile app

GETTING STARTED



Plug your Moodo into a power outlet

If you have a battery in the device:
initial charge time is 4 hours

You can continue to the next step

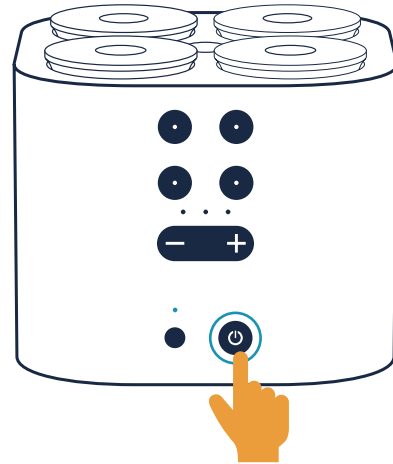

Press the "Power Button" and the blue light will start blinking.
Wait for it to stop (Moodo is searching for WiFi network).

Your Moodo device is now acting as an access point
and is ready for the setup process.



Moodo set up process

During the set-up process you will connect your smartphone to your Moodo. Then, you will update the Moodo settings with the Wi-Fi Network credentials it needs to connect to.

Let's start...

1

Download the Moodo app and create an account



2

Plug Moodo into a power outlet

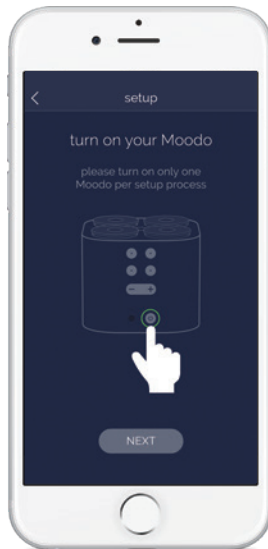

and turn it on

3

Moodo Version Selection

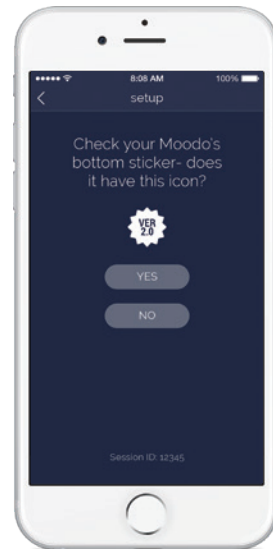

Choose "yes" to follow Version 2.0 instructions



4

Connect to Moodo Network
by tapping on

GO TO DEVICE SETTINGS

and then **Wi-Fi > Moodo**
Password: 12345678

In android: The app will try to connect to "Moodo" network automatically. If it succeeds, go to the next step.

In iPhone: You will need to manually connect to "Moodo" network.

If you can't find a network named "Moodo":
1. Make sure Moodo is on
2. Reset your Moodo: on the device, press and hold the top left button and the '+' button together until the LED starts to blink

5

Once you are connected to your Moodo device, go back to the app and tap the "open browser" button

OPEN BROWSER



6

Enter Wi-Fi credentials in the
dedicated web page

If the browser does not open,
please browse to: **192.168.1.1**

When done, go back to the mobile app:
In Android: close the browser tab
In iPhone: click "Done"



Tap the ? for
additional info

7

Wait until Moodo is
successfully connected,
then name your Moodo

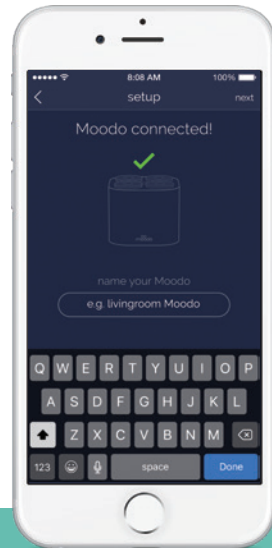

Need help? Go to connect.moodo.co

Main screen features



Custom mood screen

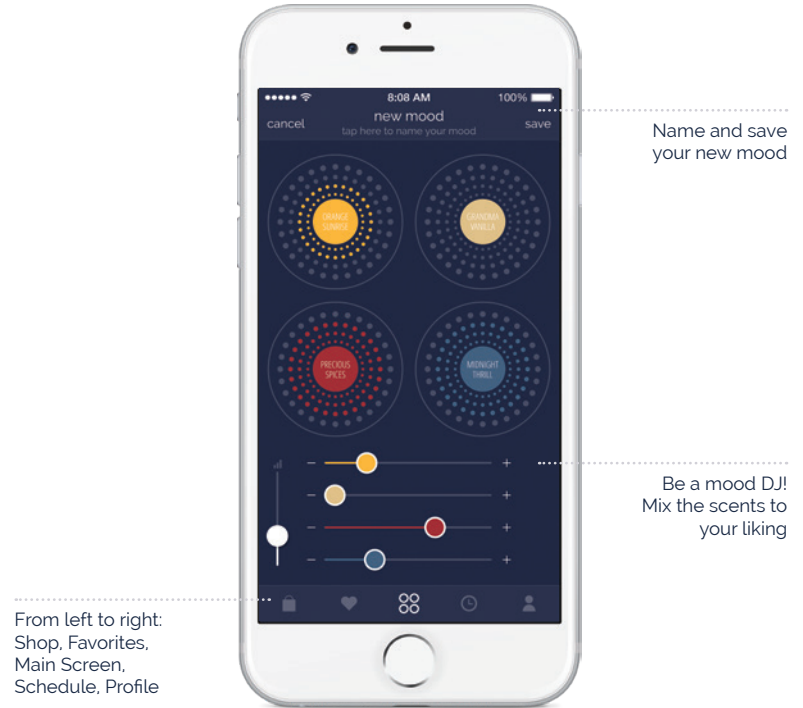

manual control

- Insert chosen fragrance capsules into the capsules holders
- If Moodo's power button is off - press it and wait for the blue light to stop blinking (Moodo is searching for Wi-Fi network)
- To control the scent capsule intensity – press the selected capsule control button and then press the scent volume to reach the preferred volume.
- To turn the scent capsule volume off – press the capsule's control button (the light should turn off)



smart-home

Moodo is designed to be compatible with leading smart home networks.

Please go to connect.moodo.co for a list of supported networks and setup instructions.

tech specs

ELECTRICAL SPECIFICATIONS

Moodo comes with a power cord & (optional) rechargeable battery

Charger input: 100-240Vac; 50/60 Hz; 0.5A

Charger output: 12Vdc; 1.5A

Battery: Li-ion rechargeable 7.4V / 2.6Ah

OPERATION CONDITIONS

Moodo app runs on both Android and iOS

The Moodo device should be operated and stored at room temperature (the device can be operated in 7 - 40°C, with a relative humidity range of 20-90% and atmospheric pressure range of 88 - 103 kPa.).

Moodo operates only with 2.4 Ghz network, secured by WEP or WPA2 personal

WARNINGS

During operation avoid contact of the device with water.

Do not locate the device near water splashes.

For external use only! Do not apply in proximity to the face.

Do not open and/or dismantle the device.

No modification of the equipment is allowed.

Do not use the device charger if the charger cord is damaged.

Do not use a different charger than the one provided with the device.

Do not use any detergents, organic solvents or chemicals for cleaning the device.



FAQ

GENERAL NOTES

Our recommended scent volume setting for a medium sized room is 50%

Under normal use, Moodo batteries will last approximately 7 hours

SETUP

Where do I find the Moodo app in the App Store / Google Play Store?

Look for "Moodo the smart home fragrance box" in the store and install the app

What should I do if my initial setup fails?

Please see troubleshooting guide, set-up wizard and support by chat at: connect.moodo.co .

If you don't find a solution at the website, please contact us at support@moodo.co

How do I control multiple Moodo devices from a single phone, without creating multiple accounts?

- Setup your first Moodo normally
- Go to App > Profile > My Devices, and tap the '+' icon on top
- Turn other devices off while the wizard is run
- Add new device and name it

How do I change the WiFi network that the device is connected to?

- Reset your Moodo to factory default (see page 12)
- Run the Wizard on your app for the new device
Profile tab > My Account > Setup Wizard
- Follow set-up instructions (page 10)

How can multiple users control the same Moodo?

- Turn on Moodo
- The first user runs the set-up wizard on their app
(Profile tab > My account > Setup Wizard)
- To connect another user, download the Moodo app to the user's phone and sign up or log-in
- Go to: connect.moodo.co and follow the instructions on how to share the Moodo device with multiple accounts

What happens if battery runs out in my Moodo?

No settings will be changed. After you plug Moodo back in to a power outlet, it will automatically connect to the previously defined WiFi and you will be able to control it from the app.

APP – MAIN FUNCTIONALITY

What are the main screens available in the app?



STORE



FAVORITES
ARCHIVE



MAIN
DASHBOARD



SCHEDULING



PROFILE

Do you offer scent presets to start me off when I load a scent family into my Moodo?

Yes we do! When you load all four capsules of a scent family, look for the pie chart shaped icons to the right of the overall volume slider.

How do I experiment and change the current scent mix?

- Tap the "+" icon to the right of the overall volume slider. Four horizontal sliders will appear, each corresponding to a scent capsule in your Moodo.
- Move the sliders to change the intensity of the different scent capsules, and use the Overall Volume slider (the white horizontal slider on the left) to change the overall intensity of the fragrance that Moodo emits.

How do I save the current scent mix?

- Tap the "Tap here to name your mood" button at the middle of the top line on the screen, and name your new preset
- Tap the "Save" button on the top right hand corner of the screen.
- You can share your personal scent mix with other Moodo users by going to the Favorites Archive screen and clicking "Share".

How do I select a scent preset or a favorite mix that I had saved before (both called "Family Members" in the app)?

The available Family Members are depicted as pie chart icons to the right of the overall volume slider.

To select, tap the Family Member of your choice.

How can I shuffle between the scent presets?

Tap the ↻ icon on the right hand side of the screen.

Moodo will shuffle between the Family Members every few minutes.

How can I turn off the fans from the app?

Tap the ⏻ icon that's located between the four large colored circles. This will turn off all fans. When you tap it again it will return to previous state.

Where do I find out how to connect my Moodo to a compatible smart home network?

Please go to connect.moodo.co to see the smart home networks Moodo is already compatible with. In addition, there is an API available for the developer community – see in the same webpage or contact us at support@moodo.co