

Artikelnummer Betriebsanleitung: **1410 0101**  
Item no. operating instructions:

**PFEUFFER**

# Operating Instructions

Seed counter

## Contador 2

Inclusive semi-automatic filling station

## Contafill 2



**Pfeuffer GmbH**  
Flugplatzstraße 70  
97318 Kitzingen  
GERMANY  
Phone: +49 9321 9369-0  
info@pfeuffer.com  
www.pfeuffer.com

Revision 8.2/23.09.2021  
Translation of the original operating instructions



---

These Operating Instructions are a constituent part of the machine and must be available to all operating personnel at all times. They are intended for the operating company of the system, the operating personnel and the specialists who are responsible for the transport, assembly, installation, operation, maintenance, cleaning, disassembly and disposal.

The Pfeuffer GmbH has prepared and reviewed these Operating Instructions with the greatest care. However, no guarantee is made for its completeness or accuracy.

Subject to technical modifications.

---

## **Translation**

In the event of delivery of subsequent sale to the countries of the European Economic Area (EEA), the operating instructions must be translated into the corresponding language of the country of use.

In the event of discrepancies in the translated text, the original operating instructions (German) must be used for clarification, or the manufacturer must be contacted.

## **Operating instructions in electronic format**

The original operating instructions (German) and translations of the original operating instructions can be requested as PDF files by e-mail: [doku@pfeuffer.com](mailto:doku@pfeuffer.com)

Specifying the correct type designation and serial number is important for further processing!

## **© Copyright**

This document is not allowed to be communicated or duplicated, utilised without express permission, which also applies to communicating its content. Offenders are liable to the payment of damages. All rights reserved with regard to patent claims or submission of design or utility patent.

(DIN ISO 16016)

<b>1</b>	<b>Introduction .....</b>	<b>5</b>
1.1	Intended use .....	5
1.2	Declaration of Conformity CONTADOR 2.....	6
1.3	Declaration of Incorporation CONTAFILL 2.....	7
1.4	Structural features of the danger notes .....	8
1.5	Pictograms in the operating instructions .....	8
1.6	Identification.....	9
<b>2</b>	<b>Safety.....</b>	<b>9</b>
2.1	Installed safety systems .....	9
2.1.1	Mains switch (plug/socket combination).....	9
2.1.2	Protective coverings.....	10
2.2	Operating and danger areas on the CONTADOR 2 .....	10
2.3	Operating and maintenance personnel.....	10
2.4	Safety measures (to be carried out by the operating company).....	10
2.5	General safety instructions.....	11
2.6	Safety tests.....	12
2.7	Residual dangers in connection with the CONTADOR 2.....	12
2.8	Switch-off procedure .....	12
<b>3</b>	<b>Technical data .....</b>	<b>13</b>
3.1	CONTADOR 2.....	13
3.2	CONTAFFILL 2 (accessories) .....	13
3.3	Marina 200 air pump .....	13
3.4	General data .....	13
<b>4</b>	<b>Delivery, transport and storage .....</b>	<b>14</b>
4.1	Standard equipment supplied .....	14
4.2	Transport and packaging .....	14
4.3	Temporary storage .....	16
<b>5</b>	<b>Function .....</b>	<b>16</b>
5.1	Overview .....	16
5.2	Functional sequence .....	17
5.2.1	Counting speeds Contador 2.....	17
5.2.2	Counting speeds with Contafill 2 .....	18
5.3	Checked and countable products .....	18
5.4	Additions and accessories.....	19
5.4.1	CONTAFFILL 2.....	19
5.4.2	Remote control – PC "SeedCount" software (option) .....	19

<b>6</b>	<b>Installation and operation.....</b>	<b>20</b>
6.1	Assembling the CONTADOR 2 .....	20
6.2	Connections and installation of the external air pump .....	20
6.3	Connection to a compressed air system.....	21
6.4	Assembling the filling station CONTAFILL 2 (optional) .....	22
6.4.1	Assembly and loading the carousel.....	23
6.4.2	Inserting the carousel.....	25
6.5	Operating the CONTADOR 2 .....	25
<b>7</b>	<b>Operation.....</b>	<b>26</b>
7.1	The function keys .....	26
7.2	Structure of the function menu .....	26
7.3	Selecting the feed container .....	29
7.4	Counting the seed/grain .....	30
7.4.1	End of the counting.....	32
7.4.2	Interrupting the count .....	32
7.4.3	Setting the gate height.....	33
7.5	Counting the seed/grain with CONTAFILL 2.....	34
7.5.1	"Bag" counting mode - CONTAFILL 2 .....	34
7.5.2	CONTAFFILL 2 – manually rotating the filling position .....	35
7.6	Switching on/off the acoustic warning signal .....	35
7.7	The hidden settings.....	35
7.7.1	Setting the display (illumination, brightness and contrast).....	36
7.7.2	Selecting the language .....	36
7.7.3	Container parameter menu .....	36
<b>8</b>	<b>Maintenance and cleaning .....</b>	<b>37</b>
8.1	Cleaning.....	37
8.2	Cleaning in the case of a dust warning .....	37
8.3	Inspection intervals and functional check .....	38
8.4	General maintenance information .....	38
8.5	Check the positioning of the lasers by means of a laser test.....	39
8.6	Renewing the equipment fuse.....	40
8.7	Checks .....	40
<b>9</b>	<b>Faults – causes and remedy .....</b>	<b>41</b>
<b>10</b>	<b>Spare parts and accessories .....</b>	<b>42</b>
<b>11</b>	<b>Emergency .....</b>	<b>43</b>
<b>12</b>	<b>Disassembly and disposal.....</b>	<b>43</b>

## 1 Introduction

### 1.1 Intended use

The CONTADOR 2 seed counter is used to count cleaned seeds such as grain, oil seeds, corn legumes and similar, dust-free products in order to establish, for example, the thousand seed weight. The maximum counting rate is 5.000 seeds/min.

It is controlled by the three function keys which are fitted to the machine and also the RS232 interface, e. g. using the PC software "SeedCount" which is available as an accessory.

The filling station, CONTAFILL 2, is required as an accessory for automatically filling the counted seeds into bags or bottles.

The CONTADOR 2 is designed as a portable machine with a power plug for interiors.

A private use of the CONTADOR 2 seed counter is not permitted.

---

**NOTICE** The machine cannot be used to count dressed seeds, items made of static plastic parts and dusty products. This can cause the light barriers to become soiled.

---

---

**NOTICE** The CONTADOR 2 is designed to be used exclusively for the purpose described.

Any use or modification that does not have the prior written approval of the manufacturer shall be considered as improper use. The manufacturer assumes no liability for damage caused by improper use. The operating company is solely responsible for any damage resulting from this.

The CONTADOR 2 may be put into operation only once it has been established that all the safety equipment is functioning.

The samples that are used for the intended use must be procured by the CONTADOR 2 operating company.

The operating company is solely responsible for the proper handling of these materials and the associated hazards.

The operating company must provide hazard and disposal information.

---

Intended use includes also the compliance with the Instruction Manual and User's Guide as well as the maintenance and servicing conditions, as specified in these Operating Instructions.

These Operating Instructions do not relieve the operating company of the obligation to develop and to apply independent health and/or safety regulations or safe working processes which are aimed at the requirements of the overall machine, as well as the obligation to monitor their compliance.

**1.2 Declaration of Conformity CONTADOR 2****EC/EU Declaration of Conformity**

In accordance with the EC/EU Directives  
Machinery 2006/42/EC and Electromagnetic Compatibility (EMC) 2014/30/EU

Manufacturer: **PFEUFFER**

**Pfeuffer GmbH**  
Flugplatzstraße 70  
97318 Kitzingen  
GERMANY

Phone: +49 9321 9369-0  
info@pfeuffer.com  
www.pfeuffer.com

This Declaration of Conformity is issued under the sole responsibility of the manufacturer.

Person responsible for collating the technical documentation: Lothar Pfeuffer, General Manager

Product: **Contador 2** Seed counter

Serial number: \_\_\_\_\_

The aforementioned product complies with the requirements of the following harmonized standards:

DIN EN ISO 12100:2011-03+corr.1:2013

DIN EN 61010-1:2020-03

DIN EN 61000-6-2:2019-11

DIN EN 61000-6-3:2011+corr.1:2012

DIN EN 61326-1:2013

In case of modification of the machine not in coordination with us this declaration expires.

Kitzingen, \_\_\_\_\_

\_\_\_\_\_  
Lothar Pfeuffer, General Manager

**1.3 Declaration of Incorporation CONTAFILL 2****Declaration of Incorporation**

for partly completed machinery in accordance to the EC Directives Machinery 2006/42/EC

Manufacturer: **PFEUFFER**  
**Pfeuffer GmbH**  
Flugplatzstraße 70  
97318 Kitzingen  
GERMANY

Phone: +49 9321 9369-0  
info@pfeuffer.com  
www.pfeuffer.com

This Declaration of Incorporation is issued under the sole responsibility of the manufacturer.

Person responsible for collating the technical documentation: Lothar Pfeuffer, General Manager

Product: **Contafill 2** Semi-automatic filling station

Serial number: \_\_\_\_\_

The manufacturer declares that the aforementioned product is a partly completed machine as defined by the Machinery Directive 2006/42/EC. The aforementioned product is intended only for installation in a machine or in a partly completed machine. Therefore, the product does not yet comply with all the requirements of the Machinery Directive.

The special technical documents were created in compliance with appendix VII, part B of the Machinery Directive.

The partly completed machine may be put into operation only if it has been stated, that the machine, into which the uncompleted machine has to be incorporated, does comply with the requirement of the machine directive.

The aforementioned product complies with the requirements of the following harmonized standards:

DIN EN ISO 12100:2011-03+corr.1:2013

DIN EN 61010-1:2020-03

DIN EN 61000-6-2:2019-11

DIN EN 61000-6-3:2011+corr.1:2012

DIN EN 61326-1:2013

In case of modification of the machine not in coordination with us this declaration expires.





Kitzingen, \_\_\_\_\_

\_\_\_\_\_  
Lothar Pfeuffer, General Manager









**1.4 Structural features of the danger notes**

The operating instructions from Pfeuffer GmbH contain instructions that you must comply with for your personal safety as well as to avoid damage to property. The instructions for your personal safety are highlighted by a warning triangle.

Comply with the following categories of danger notes and explanations of symbols:

Pictogram 	 <b>SIGNAL WORD</b>
	Type of danger and its source Possible consequence of failure to comply. ⇒ Measure to guard against the danger.
	 <b>DANGER</b>
	This is a warning about a highly dangerous situation that will lead to serious or fatal injuries.
	 <b>WARNING</b>
	This is a warning about a dangerous situation that may result in serious or fatal injuries.
	 <b>CAUTION</b>
	This is a warning of a possibly dangerous situation that will lead to slight or moderate injuries.
<b>NOTICE</b>	This is a warning about harmful situations for the product and/or environment.

**1.5 Pictograms in the operating instructions**

	Notes of particular importance and/or additional information		Warning
	Operating instructions binding		Warning about electrical voltage
	Unplug the main plug		Warning about laser radiation
	Protective earth connection		Recycling marking – Supply refuse for recycling



### 1.6 Identification

The information provided in these Operating Instructions apply only for the machine whose type designation is specified on the title page.

The type plate with the type designation can be found on the rear panel of the CONTADOR 2.

It is important that the correct type designation is specified if queries are made. This will help us to process the query in a quick and efficient manner.

Sample Pfeuffer GmbH type plate:

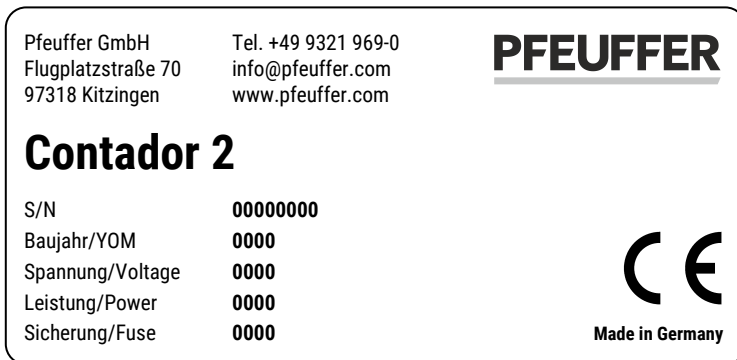

## 2 Safety

**NOTICE** It is strictly prohibited to override the safety equipment or to change its function.

### 2.1 Installed safety systems

The installed safety systems must be checked at regular inspection intervals and using the appropriate inspection methods. Refer to the following table:

Inspection interval	Inspection methods
<b>d</b> = daily	<b>V</b> = Visual check
<b>w</b> = weekly	<b>F</b> = Functional check
<b>m</b> = monthly	<b>M</b> = Measurement
<b>¼ y</b> = quarterly	
<b>½ y</b> = half-yearly	
<b>y</b> = yearly	

#### 2.1.1 Mains switch (plug/socket combination)

The CONTADOR 2 is designed as a portable machine with associated desktop power supply.



⇒ In the event of any danger, disconnect the desktop power supply from the CONTADOR 2.

Inspection	
Interval	Method
<b>m</b>	<b>V</b>

**2.1.2 Protective coverings**

The CONTADOR 2 is protected from any intervention in the machine during operation by means of a plastic housing.

Inspection	
Interval	Method
<b>m</b>	<b>V</b>

**2.2 Operating and danger areas on the CONTADOR 2**

**Operating area**

Make sure the installation height is sufficient (according to the stature of the operating personnel). A suitable base (e.g. table) is required for this.

**Danger area**

The entire area one meter around the CONTADOR 2 is a danger area during maintenance and repair work. Keep the area around the CONTADOR 2 clear of objects.

**2.3 Operating and maintenance personnel**

Operating and maintenance personnel are persons who are responsible for the transport, assembly, installation, operation, setting up and cleaning of the machine and for troubleshooting.

1. The CONTADOR 2 is only allowed to be operated by authorized and instructed people.
2. The responsibilities for operating the CONTADOR 2 must be clearly defined and complied with so that no unclear competencies arise with regard to the aspect of safety.
3. The switch-off procedures specified in the operating instructions must be complied with during all work (operation, maintenance, repair, etc.), see **chapter 2.8**
4. The operator must refrain from any working method that impairs safety on the CONTADOR 2.
5. The operator must ensure that only authorized people work on the CONTADOR 2.
6. The owner is obliged to report immediately to the owner any changes that take place on the CONTADOR 2 which impair safety.
7. The operating personnel must be provided by the owner with appropriate protective equipment in accordance with legal requirements and the material to be processed.
8. The owner must issue regular instructions regarding the use of personal protective equipment, and must check such equipment is being used.

**2.4 Safety measures (to be carried out by the operating company)**

We draw your attention to the fact that the operating company must ensure that the operating and maintenance personnel

- ⇒ are instructed about the safety equipment of the CONTADOR 2
- ⇒ comply with the safety measures.

The frequency of the functional checks as described in **chapter 8.3** must be complied with.

The work described in these Operating Instructions is specified such that

- ⇒ the chapters Function and Operation are understood by the operating personnel
- ⇒ the chapters Delivery, Transport and storage, Installation and operation, Maintenance and cleaning, Faults – causes and remedy and Disassembly and disposal are understood by a **specialist**.

The chapters Delivery, Transport and storage, Installation and operation, Maintenance and cleaning, Faults – causes and remedy and Disassembly and disposal are understood by a **specialist**. The work described in this chapter is intended to be carried out **only by** specialists.

### Instructed person

A person who has been instructed and, if necessary, trained by a **specialist** with regard to the duties they are to perform and the possible hazards of any improper conduct; and have been taught about the necessary safety equipment and safety measures.

### Specialist

An individual who, on account of their relevant, specialist education, training and/or expertise is capable of detecting risks and avoiding hazards that can arise when using the product.

(Definition in accordance with DIN EN 82079-1:2013-06)

### Obligations of the operating company



In the European Economic Area (EEA), the national implementation of the framework directive 89/391/EEC as well as the associated individual directives and, of which, in particular the guideline 2009/104/EC "concerning the minimum safety and health requirements for the use of work equipment by workers at work", in each case in the current version must be observed and complied with.

The local, legal provisions must also be complied with for:

- ⇒ Safety of personnel (accident prevention regulations)
- ⇒ Accident prevention regulation DGUV Regulation 3 (previously BGV A 3) "Electrical systems and equipment" (DGUV = Association of German Statutory Accident Insurance)
- ⇒ Safety of work equipment (protective equipment and maintenance)
- ⇒ Product disposal (waste legislation)
- ⇒ Material disposal (waste legislation)
- ⇒ Cleaning (cleaning agents and disposal)
- ⇒ Hazardous substances (in Germany, the technical rules for hazardous substances – TRGS 555 apply)
- ⇒ Environmental protection regulations

### Electrical connections



The desktop power supply of the CONTADOR 2 may be connected only to a properly earthed socket with protective conductor.

## 2.5 General safety instructions



The safety equipment and safety instructions described in these Operating Instructions must be observed.



1. In the case of a fault, disconnect the equipment from the mains.
2. Always disconnect the equipment from the mains prior to cleaning.
3. Do not allow the equipment to become wet during transport, storage, cleaning and operation.
4. Ensure that the CONTADOR 2 is used only when it is in perfect condition.
5. Never touch the mains cable with wet hands.
6. Use only the original spare parts and accessory parts (refer to **chapter 10**).

## 2.6 Safety tests

Pfeuffer GmbH carried out the following safety tests at the factory:

Testing and checking according to DIN EN 60204-1:

- Check that the electrical equipment is in compliance with the technical documentation.
- Continuous connection of the protective earth system
- Insulation resistance tests
- Voltage tests
- Protection against residual voltages
- Function tests

The functions of the electrical equipment, in particular those relating to safety and protective measures, have been tested.

## 2.7 Residual dangers in connection with the CONTADOR 2

⇒ During all work on electrically operated components, pay attention to dangers from electrical current.

## 2.8 Switch-off procedure



 **DANGER**

**Touching live parts can be fatal!**

It is essential to comply with the following switch-off procedure prior to cleaning, maintenance or repair work (only by specialist personnel):

⇒ Empty the CONTADOR 2.

⇒ Switch off the CONTADOR 2 at the main switch.



⇒ Disconnect the mains cable from the electrical power supply.

⇒ The mains cable must be able to be kept under the direct supervision of the person in the danger area.

⇒ During cleaning, make sure that no water, steam or dust can penetrate the electronics area.

### 3 Technical data

#### 3.1 CONTADOR 2

Dimensions	375x168x185 mm
Weight	approx. 5 kg
Power supply (via desktop power supply ETC45G-24)	Input: 100-240 V <sub>AC</sub> / 47-63 Hz Output 24 V <sub>DC</sub> , max. 1.88 A Power consumption: 24 VA
Container volumes no. 1 rapeseed no. 2 grain no. 3 maize, legumes no. 4 fine seeds	approx. 240 cm <sup>3</sup> approx. 270 cm <sup>3</sup> approx. 260 cm <sup>3</sup> approx. 230 cm <sup>3</sup>
Front	Illuminated LCD with 4 rows à 16 characters, 46.0 x 18.5 mm, 3 function keys
Rear panel	Connection for RS232 (9-pin. DSub socket), CONTAFILL 2 (15-pin. DSub socket), Foot switch (3.5 mm jack socket), Desktop power supply, External air pump, Equipment fuse (5x20 mm glass tube, T1A), On/off switch (flip switch)



Figure 1: CONTADOR 2

#### 3.2 CONTAFILL 2 (accessories)

Dimensions without carousel	520x420x345 mm
Dimensions with carousel	620x420x345 mm
Weight without carousel	9 kg
Weight complete with carousel and cable	approx. 11.5 kg
Weight carousel for bags and bottles	2.4 kg
Power supply	24 V <sub>DC</sub> via CONTADOR 2 15-pin. DSub socket

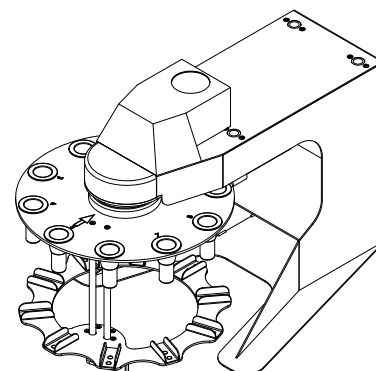

Figure 2: CONTAFILL 2

#### 3.3 Marina 200 air pump

Technical data	220-240 V <sub>AC</sub> , 50 Hz, 4 W
----------------	--------------------------------------

#### 3.4 General data

Ambient temperature storage and transport	-10 °C to +60 °C
Ambient temperature operation	+5 °C to +40 °C
Atmospheric humidity	20 % to 80 % non-condensing

**4 Delivery, transport and storage**



The Delivery, transport and storage chapter is only intended for **specialist operators**.

**4.1 Standard equipment supplied**

The standard scope of delivery to the owner comprises:

1. CONTADOR 2 Seed counter
2. Power supply
3. Mains cable with rubber connector
4. Marina 200 air pump
5. 4 mm PVC hose (for air pump)
6. T-piece for 4 mm hose
7. Cleaning brush
8. Operating Instructions

The relevant item numbers can be found in **chapter 10**.

**4.2 Transport and packaging**

Systems and machines supplied by the Pfeuffer GmbH will be carefully checked and packaged prior to dispatch, however, damage during transport cannot be excluded.

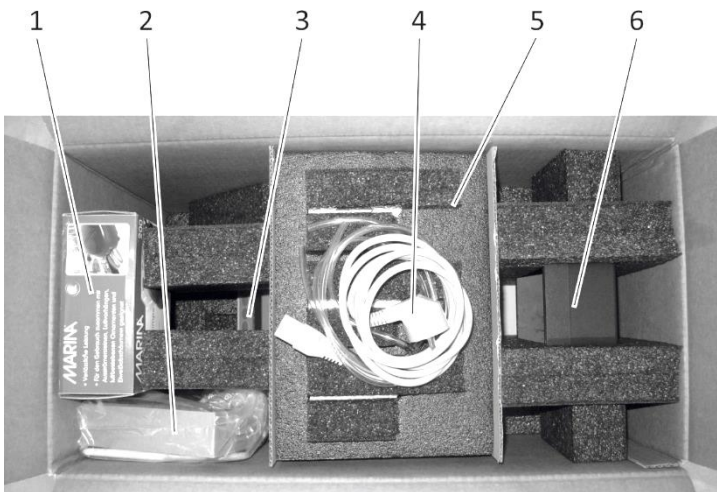

Figure 3: CONTADOR 2 packaging

Pos.	Name	Pos.	Name
1	Air pump	4	Power cable, PVC hose
2	Accessories, power supply	5	Feed container 1–4 (option)
3	Seed counter CONTADOR 2	6	Drawer

**Incoming inspection**

Use the delivery note to inspect the completeness.

**In the case of damages**

Check the delivery for damages (visual check).

**In the case of complaints**

If the delivery has been damaged during transport:

- ⇒ Keep the packaging (for the freight company to check or for return shipment).
- ⇒ Inform the suppliers or the Pfeuffer GmbH immediately.

**Unpacking or Packaging**

- ⇒ In order to avoid damages to the casing and other components, open the packaging.

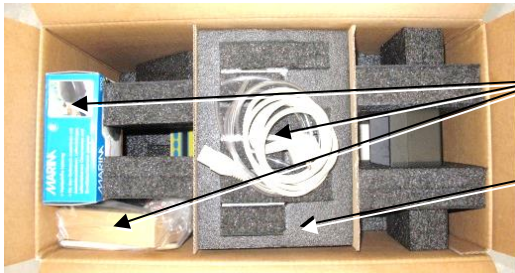

- ⇒ Take out the power plug, the PVC hose (incl. T-piece), the power supply, the brush, the air pump Marina and the operating instructions.
- ⇒ Remove the packing elements via the containers.

Figure 4: Packaging complete



- ⇒ Pull out the containers gently at the two ends of the cardboard.

Figure 5: Packaging container



- ⇒ Take out the drawer and the complete upper packing element.

Figure 6: Packaging drawer



- ⇒ Lift up the CONTADOR 2 out of the box.
- ⇒ Make sure that the CONTADOR 2 will only fit in one direction into the lower packing element (because of the stand feet). Only in this way, a horizontal level is guaranteed.

Figure 7: Packaging CONTADOR 2



- ⇒ Use the original packaging and original packaging material.
- ⇒ If both are unavailable, request a new packaging from Pfeuffer GmbH.

Figure 8: Packaging cardboard floor

### 4.3 Temporary storage

The freight packaging of the CONTADOR 2 and the accessories and replacement parts is designed to be stored for six months as of delivery.

#### Storage conditions

Closed and dry room with a room temperature of min. -10 °C to max. +60 °C

## 5 Function

### 5.1 Overview

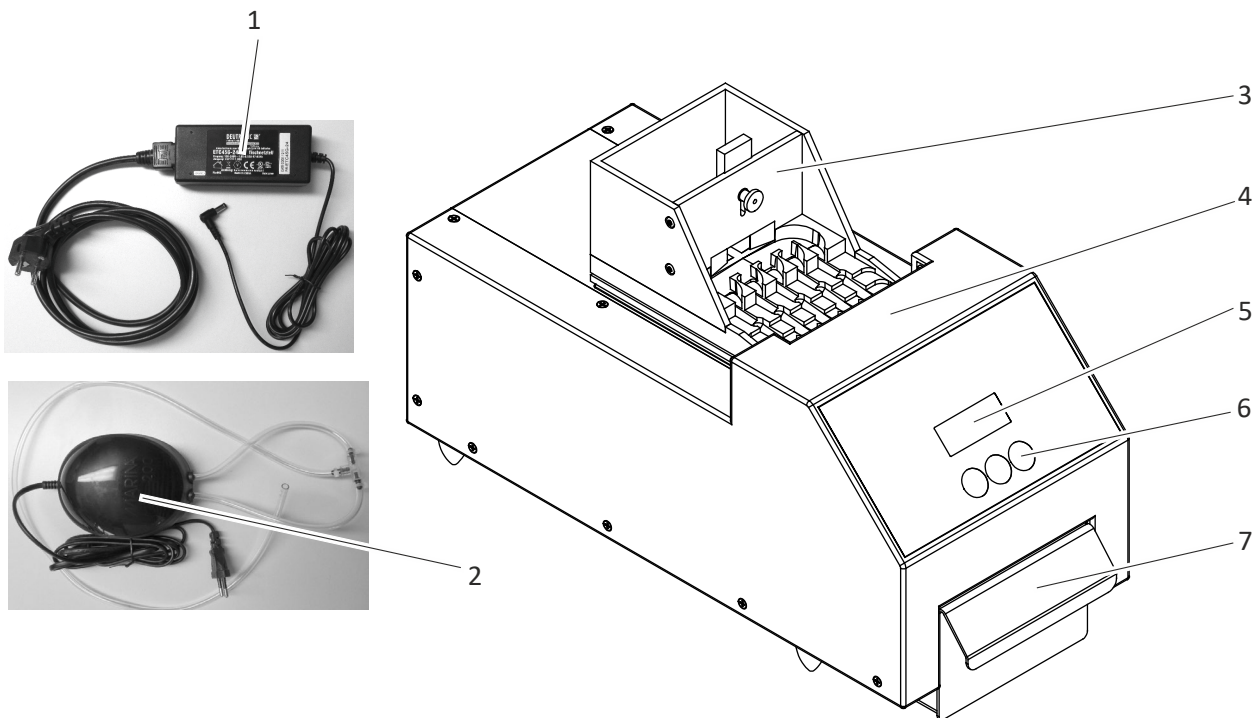

Figure 9: CONTADOR 2 – Components



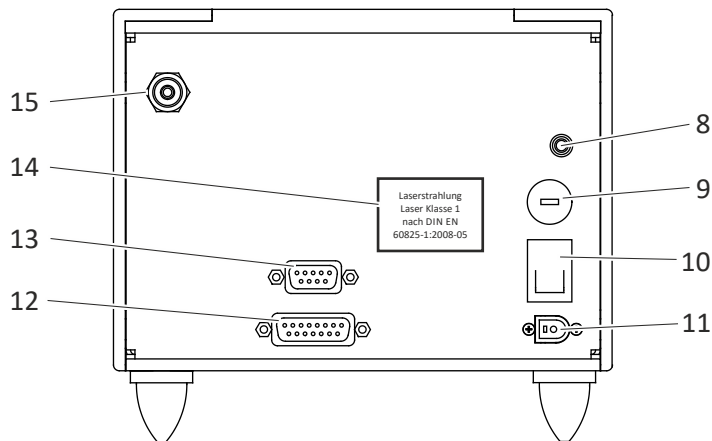

Figure 10: CONTADOR 2 – Machine rear panel

Pos.	Name	Pos.	Name
1	Desktop power supply	9	Equipment fuse
2	Air pump	10	Mains switch
3	Feed container	11	Desktop power supply connection
4	Light barrier	12	CONTAFILL 2 connection
5	LCD-display	13	RS232 socket for external control
6	Function keys	14	Sticker – laser radiation class 1
7	Drawer	15	Air pump connection
8	Foot switch connection		

## 5.2 Functional sequence

The filled feed container is positioned at the place intended for the CONTADOR 2.

The machine automatically detects the feed container (container no. 1 for rapeseed and small seeds, container no. 2 for grain, container no. 3 for maize and legumes and container no. 4 for fine seeds) and then loads the optimum parameters for this.

Having set the counted quantity, the count starts.

The feed container is held by a magnet and is kept vibrating by means of a vibration element. The vibration causes the product to be counted to flow through the gate of the feed container and it distributes itself evenly on the five counting channels where it is separated.

The optimum feed speed is ensured by a counting algorithm.

The channels guide the product to be counted to the outlets where it falls through the light barriers and into the drawer.

A connected air pump ensures a continuous flow of air which prevents abrasion or dust particles which could impair the function of the light barriers.

### 5.2.1 Counting speeds Contador 2

Orientation values:

Container	Product	Grains/minute	Duration/1000 grains
1	Rapeseed	5000	12 s
2	Wheat	2400	25 s
3	Maize(corn)	1200	50 s
4	Lavender	1400	45 s

**5.2.2 Counting speeds with Contafill 2**

Orientation values:

Container	Product	Bags/minute@1000 grains	Duration/bag
1	Rapeseed	3	20 s
2	Wheat	2	30 s
4	Lavender	1	60 s
Container	Product	Bags/minute@500 grains	Duration/bag
3	Maize (corn)	1	50 s

**5.3 Checked and countable products**

Examples of suitable seeds:

Feed container			
1	2	3	4
Rapeseed	Wheat	Maize	Carrot
Cauliflower	Barley	Sunflowers	Viola
Lettuce	Rye	Zucchini	Lavender
Tomato	Oats	Field beans	Garden cress
Onion	Triticale	Nasturtium	
White cabbage	Soya beans	Peas	
Lucerne	Eggplant		
Clover	Paprika		
Timothy grass	Cucumber		
Millet	Morning Glory		
	Sweet pea		
	Buckwheat		

## 5.4 Additions and accessories

### 5.4.1 CONTAFILL 2

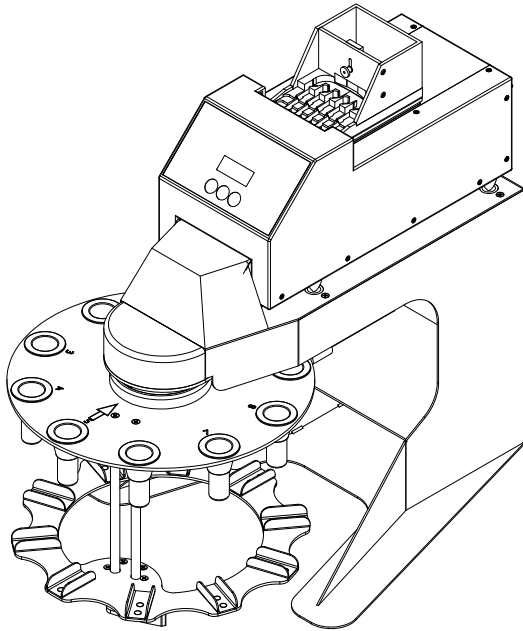

The CONTAFILL 2 semi-automatic filling station is used to quickly fill small batches of seed, grains and similar products (refer to **chapter 1.1**) in any quantity (from 1 to 99.999) in bags (paper/plastic) or bottles (plastic/glass).

The CONTAFILL 2 consists of a stainless steel housing with interchangeable carousels for 10 bags or bottles of between 50 and 200 mm in length, and installed electronic sensor for detecting the bags.

Transparent bags and bottles are not detected by the sensor. This can be remedied by attaching a label.

Refer to **chapter 6.4** for more information about assembling and operating the CONTAFILL 2.

Figure 11: CONTADOR 2 with connected filling station CONTAFILL 2



Figure 12: Stand with carousel

When **operating mode P** is selected (refer to **chapter 7.5.1**), a carousel with full bags can be removed from the CONTAFILL 2 and a second carousel with empty bags inserted.

The filling process can be continued while the full bags from the first carousel are being removed and it is then provided with empty ones for the next pass. The stand, which is available as an accessory, makes this process a lot easier.

### 5.4.2 Remote control – PC "SeedCount" software (option)

The software enables series of samples to be filled together with the filling station, CONTAFILL 2. You can specify the number of bags and the desired number of seeds. Heterogeneous count lists can be processed in the form of XLS tables. A label printer prints out data such as the test location and number of seeds.

**6 Installation and operation**

**6.1 Assembling the CONTADOR 2**



The Installation and operation chapter is intended only for **specialists**.

⇒ Carefully unpack the CONTADOR 2 and position it horizontally.



A correct, horizontal assembly of the machine guarantees an even distribution of the seeds in the feed channels.

⇒ Position the machine on a work table and make sure it is set up ergonomically.  
(Working height of approx. 70-80 cm)

**6.2 Connections and installation of the external air pump**

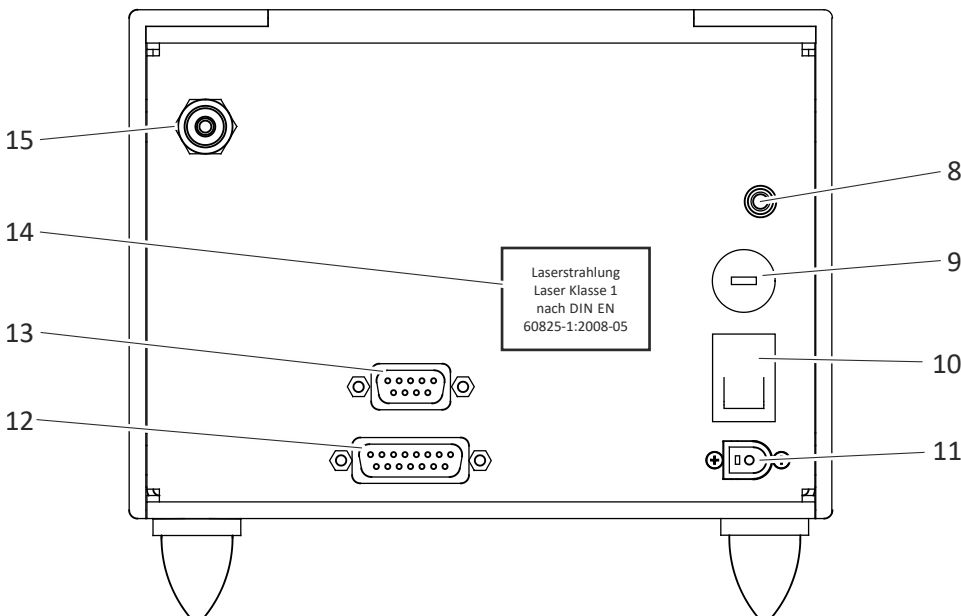

Figure 13: Connections on the rear panel of the machine

Pos.	Name
8	Foot switch connection
9	Equipment fuse
10	Mains switch
11	Desktop power supply connection
12	CONTAFFILL 2 connection
13	RS232 socket for external control
14	Sticker – laser radiation class 1
15	Air pump connection

### Connection of the external air pump

⇒ Connect the PVC hose with the Marina 200 air pump as shown in **figure 14**.



Figure 14: Marina 200 air pump

⇒ The connection points on the T-piece must also be secured using cable ties, refer to **figure 15**. Use the PVC hose to connect the air pump with the CONTADOR 2. During operation, the air pump must be connected to a 230 V<sub>AC</sub> socket.

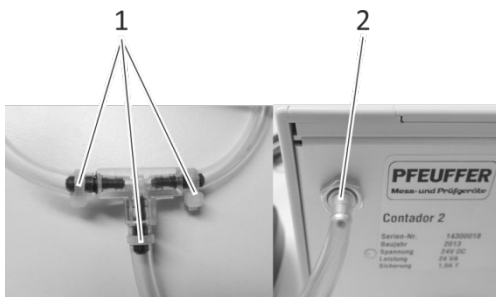

Figure 15: Connection points of the Marina 200 air pump

Pos.	Name
1	Cable ties
2	Connection – air pump to CONTADOR 2

### 6.3 Connection to a compressed air system

The CONTADOR 2 can be connected to a compressor or a compressed air system.

Operating the seed counter with a compressor or a compressed air system is permitted subject to the following conditions:

#### **NOTICE**

Compressed air systems with higher pressure have to be equipped with a pressure control valve (pressure reducer) with downstream pressure limit valve in the air line.

The compressed air must be filtered, dry and free of oil as this might leave an unwanted film on the light barrier.

Pfeuffer GmbH recommends setting the air pressure to approx. 100 mbar.

Depending on the texture of the seeds and the resulting dust, the setting can be increased to a maximum of 200 mbar.

The indicated air pressure value is only a guideline, as the counting precision with different air pressures highly depends on the size and weight of the counted seeds.

**6.4 Assembling the filling station CONTAFILL 2 (optional)**

⇒ Carefully unpack the CONTAFILL 2 and position it horizontally.

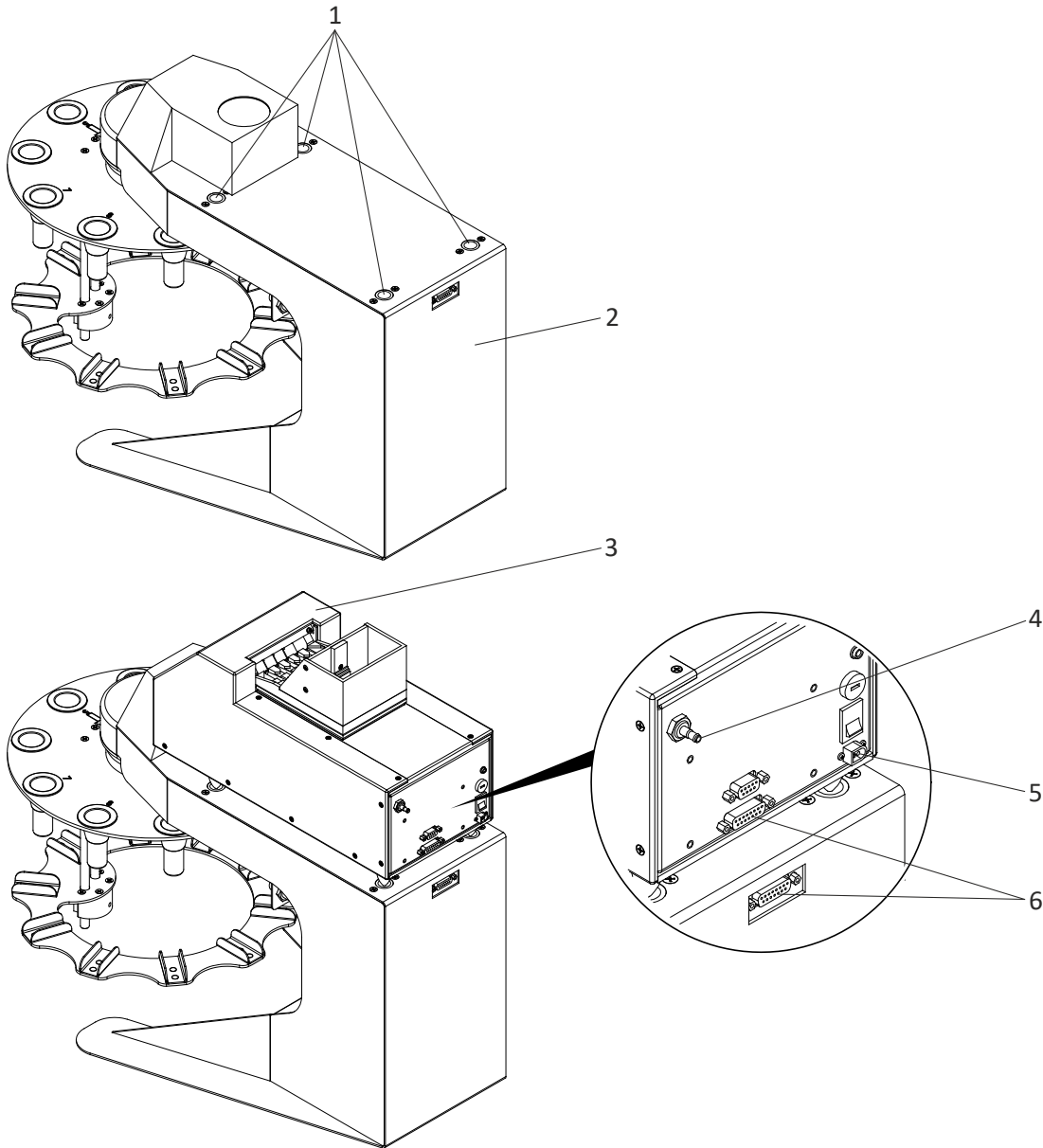

Figure 16: Position the CONTADOR 2 on the CONTAFILL 2 filling station

Pos.	Name	Pos.	Name
1	Placing feet	4	Connection air pump
2	CONTAFFILL 2	5	Connection desktop power supply
3	CONTADOR 2	6	Connection CONTADOR 2 to CONTAFFILL 2 (Connection cable included in delivery of CONTAFFILL 2)

- ⇒ Position the CONTADOR 2 on the CONTAFFILL 2 filling station, as show in **figure 16**.
- ⇒ Ensure that the feet of the seed counter are located in the intended positions.
- ⇒ Connect the air pump and the desktop power supply to the CONTADOR 2 (refer to **chapter 6.2**).
- ⇒ Use the connection cable to connect the CONTAFFILL 2 filling station to the CONTADOR 2.

### 6.4.1 Assembly and loading the carousel

⇒ Assemble the carousel as shown in the figure below.

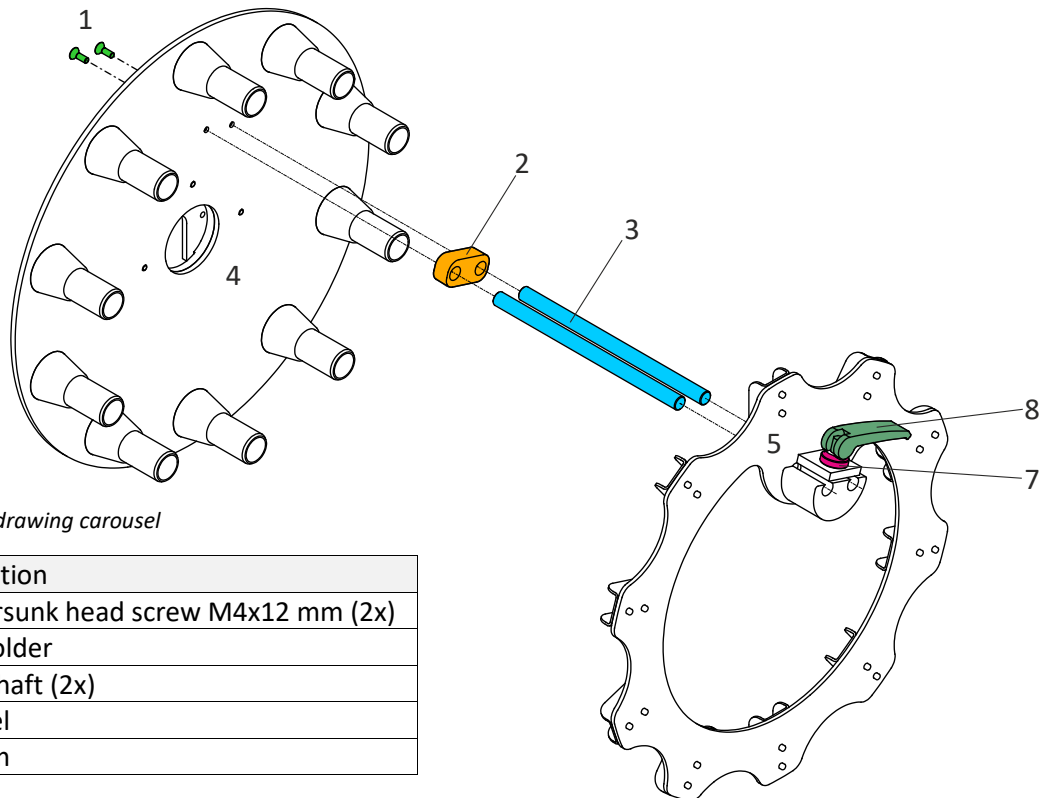

Figure 17: Assembly drawing carousel

Item	Designation
1	Countersunk head screw M4x12 mm (2x)
2	Shaft holder
3	Guide shaft (2x)
4	Carousel
5	Platform

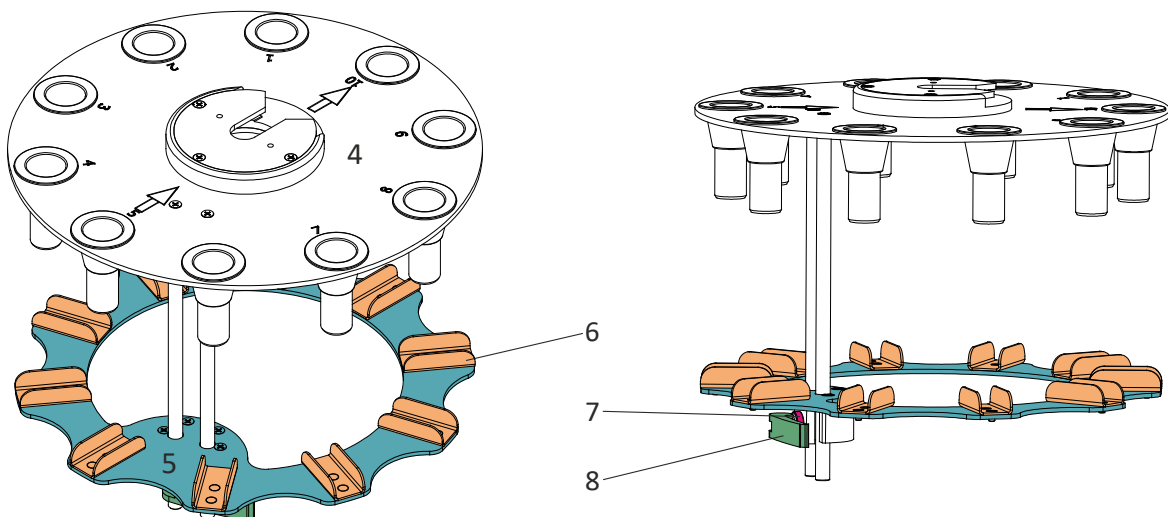

Figure 18: Carousel for bags and bottles

Item	Designation
6	U-shaped holder for bags
7	Knurled nut
8	Eccentric tensioner

⇒ Adjust the height of the platform by loosening the eccentric tensioner and determining the desired height.

⇒ If the adjustment is too loose, tighten the knurled nut on the tensioner tighter.



Figure 19: Loading with bags 11.5x20 cm



Figure 20: Loading with bags 8x12.5 cm

**Modification for bottles**

The U-shaped holders on the platform are fastened with plastic countersunk expanding rivets.

⇒ Push out the countersunk expanding rivets and keep all individual parts in a safe place.

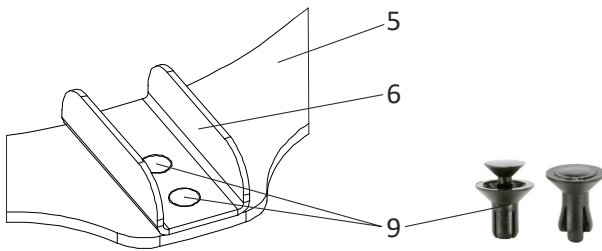

Figure 21: Countersunk expanding rivets

Item	Designation
5	Platform
6	U-shaped holders for bags
9	Countersunk expanding rivets



Figure 22: Platform modified for bottles



Figure 23: Loading with bottles Ø 7,5x16 cm



## 6.4.2 Inserting the carousel

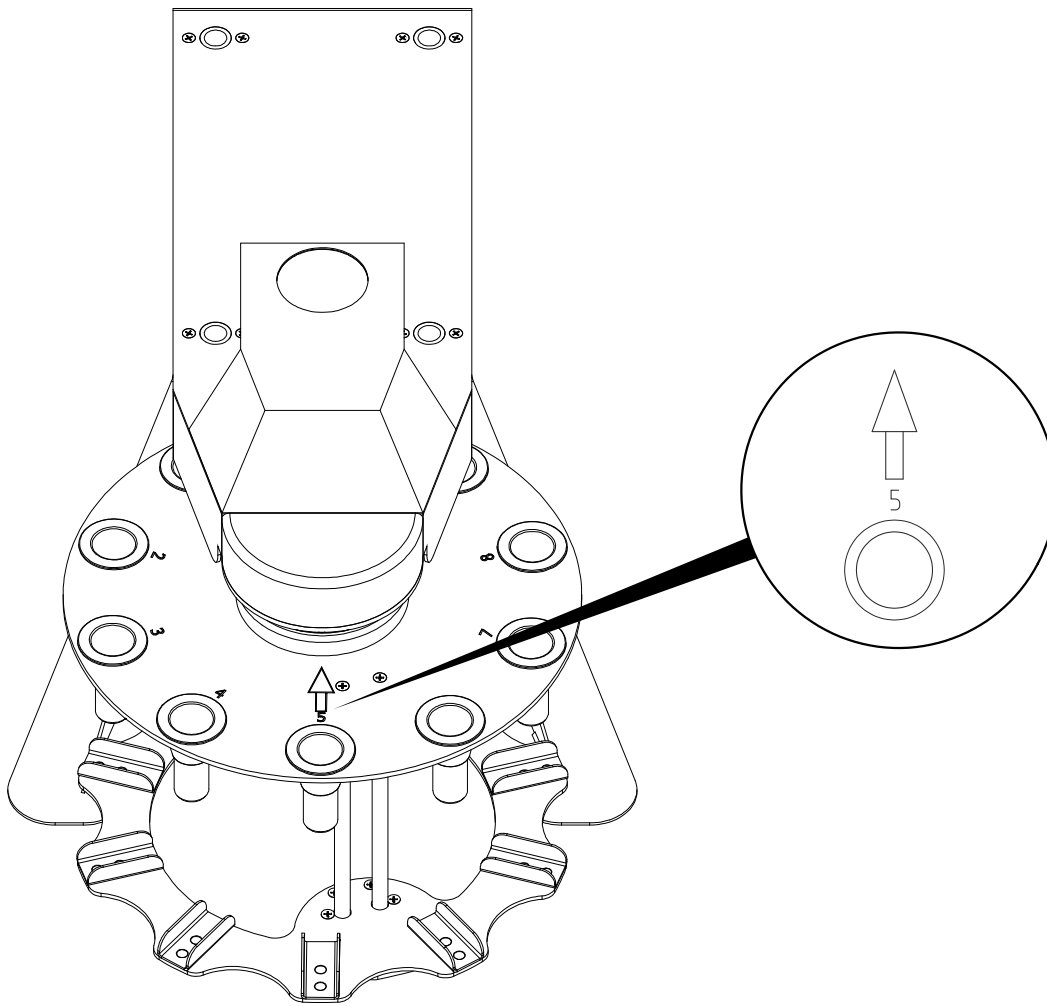

Figure 24: Inserting the carousel

- ⇒ Carefully insert the carousel in the direction of the engraved arrow (at position 5) into the filling station. A little pressure engages the carousel with the holding device of the CONTAFILL 2.
- ⇒ If you wish to remove the carousel, rotate it via the menu `turn` (refer to **chapter 7.5.2**) so that the position 5 and the engraved arrow are located at the front.
- ⇒ Release the carousel out of the engaged position.

## 6.5 Operating the CONTADOR 2

- ⇒ Make sure all the components have a firm fit.



- ⇒ Plug the external desktop power supply ETC45G-24 into a 230 V<sub>AC</sub> socket with protective conductor.

- ⇒ Position a feed container on the seed counter.
- ⇒ Insert the drawer (without CONTAFILL 2).
- ⇒ Switch the CONTADOR 2 on at the mains switch.
- ⇒ Start the external air pump.
- ⇒ Observe the information concerning operation in **chapter 7**.

7 Operation



The CONTADOR 2 may be operated only by qualified and trained operating personnel.

7.1 The function keys

The CONTADOR 2 is operated by three function keys which are fitted to the front of the machine. Use the keys to select the inversely shown fields in the display.

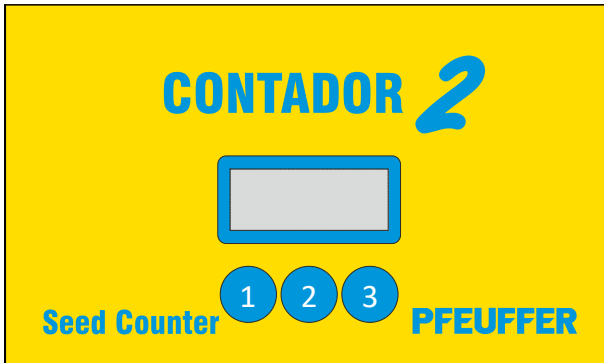

Figure 25: Function keys

Pos.	Function key
1	Start
2	Set
3	Stop

7.2 Structure of the function menu

Menu view on the display

After switching on the CONTADOR 2 at the mains switch the counting menu appears:

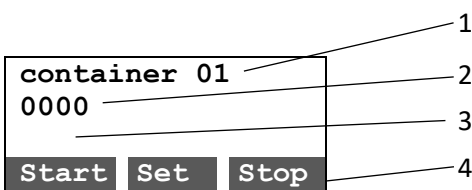

Row	Name
1	Designation and number of the positioned feed container
2	Established count value (display on the left-hand side above <b>Start</b> ) and the current count (display on the right-hand side above <b>Stop</b> , with continuous counting)
3	Operating notes with continuous counting
4	Description of the key function

**Set** takes you to the main menu.

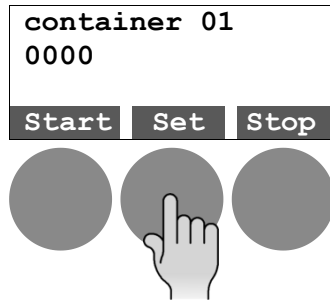

↑ and ↓ move you through the menu, and choose a menu item with **Set**.

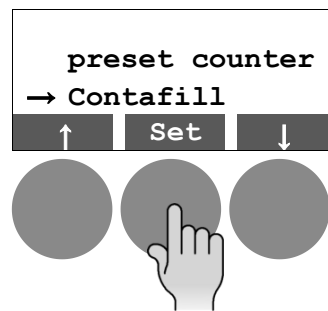
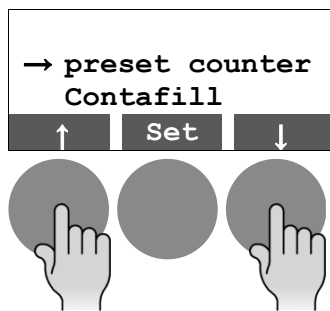

**Menu navigation**

Counting menu

Main menu

Button

Buttons ↓↑

Button

container 01	Set	preset counter	Set	<b>Chapter 7.4</b>
		contafil	Set	Submenu
		<b>Chapter 7.5</b>		
		container	Set	<b>Chapter 7.3</b>
		beep	Set	<b>Chapter 7.6</b>
		version	Set	<b>Chapter 9</b>
		code	Set	Hidden settings
		<b>Chapter 7.7</b>		
		<----	Set	Back to counting menu

Main menu

Submenu

Buttons ↓↑

Button

Buttons ↓↑

Button

contafil	Set	bags	Set	<b>Chapter 7.5.1</b>
<b>Chapter 7.5</b>		turn	Set	<b>Chapter 7.5.2</b>
		<----	Set	Back to counting menu

Main menu		Hidden settings	
Buttons ↓↑	Button	Buttons ↓↑	Button
code <b>Chapter 7.7</b>	Set	language	Set <b>Chapter 7.7.2</b>
		dirt alarm	Set
		default	Set
		display <b>Chapter 7.7.1</b>	Set Submenu
		container set. <b>Chapter 7.7.3</b>	Set Submenu
		laser test	Set <b>Chapter 8.5</b>
		<-----	Set Back to counting menu

Hidden settings		Submenu	
Buttons ↓↑	Button	Buttons ↓↑	Button
display <b>Chapter 7.7.1</b>	Set	lighting onoff	Set
		brightness	Set
		contrast	Set
		<-----	Set

Hidden settings		Submenu	
Buttons ↓↑	Button	Buttons ↓↑	Button
container set. <b>Chapter 7.7.3</b>	Set	AUTOSET	Set
		G-Sensor	Set
		frequency	Set
		power	Set
		ramp down	Set
		betw. grain cnt	Set
		pixel per line	Set
		lines	Set
		pixel total	Set
		<-----	Set

### 7.3 Selecting the feed container

The positioned feed container is detected automatically. The bottom of the containers are provided with magnets which are used to detect the number, and the associated parameters for the light barrier and feed are selected automatically.

At present you can choose from four different feed containers:



Figure 26: Feed container

Feed container	Orientation value for grain size	Container volume	Grain capacity
No. 1 for rapeseed and fine seeds	$\varnothing < 3 \text{ mm}$	240 cm <sup>3</sup>	Rapeseed ~ 45.000
No. 2 for grain	$\varnothing < 6 \text{ mm}$	270 cm <sup>3</sup>	Wheat ~ 4500
No. 3 for maize and legumes	$\varnothing < 10 \text{ mm}$	260 cm <sup>3</sup>	Maize (corn) ~ 600
No. 4 for fine seeds	$\varnothing < 2 \text{ mm}$	230 cm <sup>3</sup>	–



**Chapter 5.3** offers a selection aid for tested seeds.

#### Selecting the counting menu for containers

The CONTADOR 2 works with an automatic container detection. In the counting menu, you can set the container number manually using the ++ or -- keys.

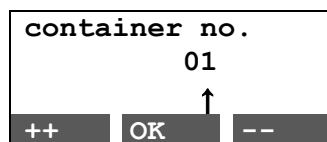

Independent settings for any container can be set, saved and called up under container numbers 8 to 15. The actual container number is then ignored.



If you want to set different values for a container, then contact the Pfeuffer GmbH.

**7.4 Counting the seed/grain**

After switching on the CONTADOR 2 at the mains switch the counting menu appears.

- ⇒ Use the three metal pins to position the required feed container on the CONTADOR 2.
- ⇒ Make sure the area is clean.

The CONTADOR 2 automatically detects the feed container. Refer to **chapter 7.3** for selecting the container.

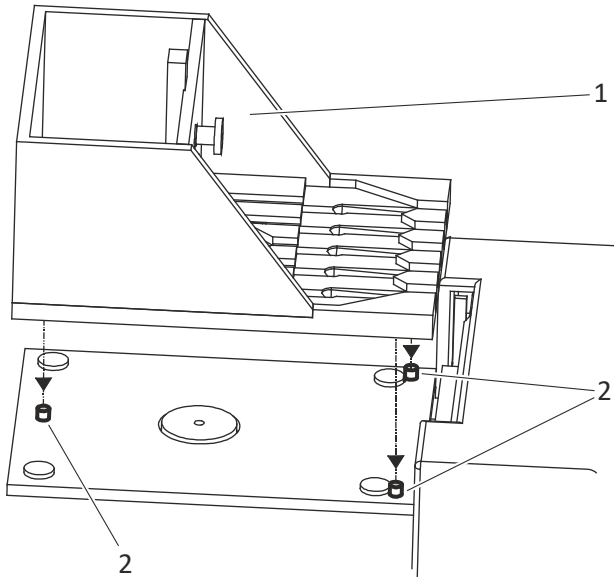

Figure 27: Positioning the feed container

Pos.	Name
1	Feed container
2	Metal pins

- ⇒ Insert the drawer.
- ⇒ Fill the desired seed in the feed container. Refer to **chapter 5.2.2** for selecting the seeds.

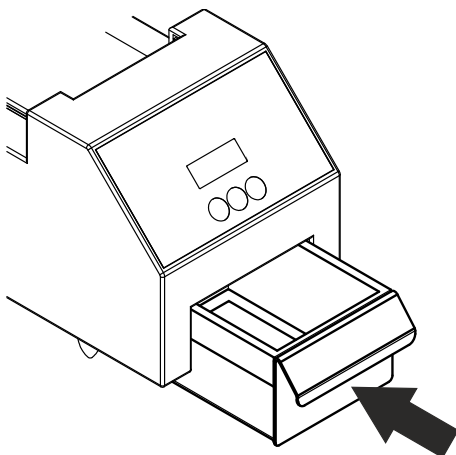
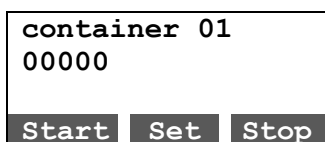

Figure 28: Inserting the drawer

Press **Set** once in order to set your count value in the main menu.



Then select the menu item **preset counter** using the  $\uparrow\downarrow$  keys and confirm with **Set**.



With **Next** select the desired digit position. The  $\uparrow$  in the third row of the display highlights the digit position that is to be processed. Use **++** or **--** to increase or reduce the digit position.

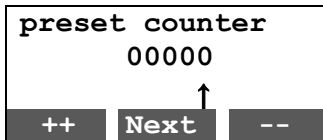

In order to enter a count value from 1,000 as shown in the following example, select 3x **Next** and then 1x **++**. After setting up, confirm the count value with **Next**.

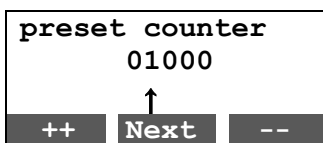

Confirm your entry by selecting:

- No** the count value can be established again
- Yes** back to the main menu

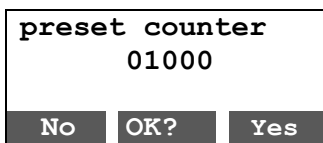

Back in the main menu, press **Start** to commence the count.

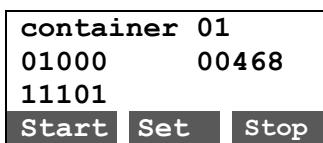
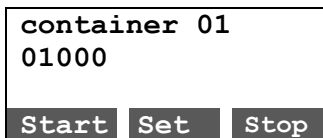

A count starts only if

- a drawer is located in the drawer compartment of the machine:

If the drawer is missing, the third row of the display will show an "S":

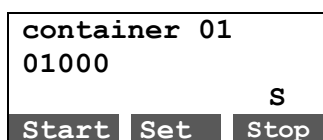

- a feed container is positioned.
- the set count value is not 00000.

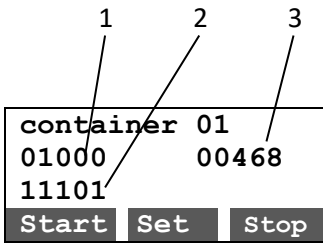

Pos.	Name
1	Established count value
2	Activity of the five light barriers
3	Current count

**7.4.1 End of the counting**

Shortly before the counting process is finished the CONTADOR 2 reduces the counting speed in two steps, first slightly and then stronger.

When reaching the preset value the vibrating unit automatically stops the CONTADOR 2.

Particularly with regard to round seeds it might happen that single seeds continue to roll over the five channels.

Therefore the light barrier will still be active for a short period of time (1 s) and is thus able to detect those seeds which continue to fall through.

The end of the counting is reached when the light barrier is off.

**7.4.2 Interrupting the count**

A count can be interrupted manually by pressing **Stop**.

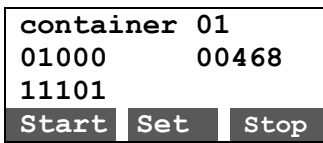

An interruption also takes place if:

1. the feed container has run empty

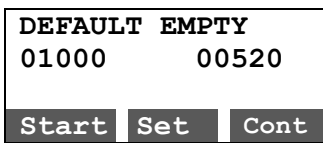

2. the drawer is removed

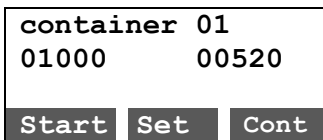

3. if there is dust on the light barrier (refer to **chapter 8.2**)

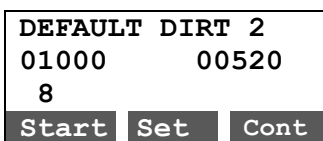

If the count is interrupted before it has reached the count value, you can continue again with **Cont**.



### 7.4.3 Setting the gate height

The counting speed is influenced, among other factors, by the set gate height. It must be adapted to the size of the product to be counted.



Figure 29: Flow of the seeds into the channels

The gate height is set correctly, if

- with a full feed container and continuous counting all the channels are evenly filled
- there are no large gaps
- the product to be counted is not adjoining each other and does not jump.

Initially, adjust the gate height so that the product to be counted can just pass through. Start the count and observe the flow of the seeds.

The projection of the threaded bar on the fine adjustment wheel (D) or the slide projection (E) can be read off and checked using vernier calipers. The values established can be used to create a list as a reference.

**NOTICE** Never adjust the gate height during the count!  
This can cause damage to the CONTADOR 2.

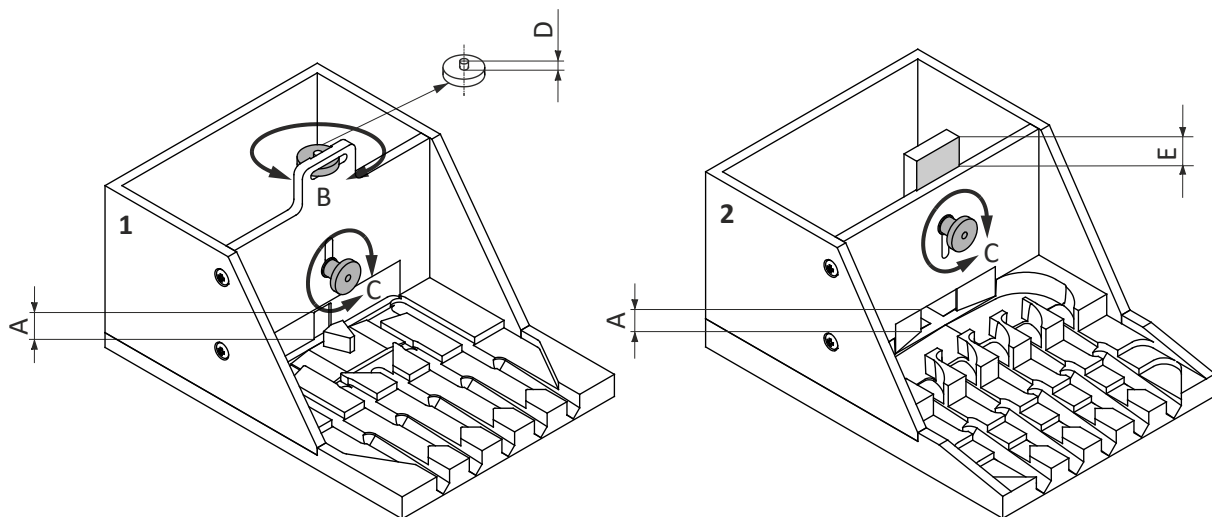

Figure 30: Setting the gate height

Pos.	Name
1	Container no. 1
2	Container no. 2
A	Gate height
B	Fine adjustment wheel
C	Adjustment wheel
D	Projection of the threaded bar on the fine adjustment wheel
E	Slide projection

## 7.5 Counting the seed/grain with CONTAFILL 2

An electronic sensor enables the machine to automatically detect whether or not a bag or bottle is positioned in the filling position of the carousel. If no container is located at the appropriate position, the carousel rotates automatically by one position without losing the product to be counted.

### 7.5.1 "Bag" counting mode - CONTAFILL 2

First of all, establish the count value (refer to **chapter 7.4**). Then select menu item **Contafill** and confirm with **Set**.



**bags** and **turn** can be selected as menu sub-items.



Go to the respective submenu with **Set**.

In the **bags** submenu you can choose between two different operating modes:

#### 1. Operating mode "B"

If, as in the example below, you have set 10, the CONTAFILL 2 will work until 10 bags/bottles have been filled.

Filling positions which do not have containers will be skipped.

In doing so, empty bags are positioned on the left and filled ones taken on the right until the chosen number of bags has been reached.



#### 2. Operating mode "P"

If, as in the example below, you have set 10, the CONTAFILL 2 will work until all 10 positions have been processed. Available bags/bottles will be filled.

If a container is available at just one filling position, then only this container will be filled.

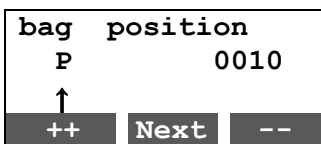

**Operating mode P** is intended for counting large batches without the need for constant operator - intervention.

Once all parameters have been set, **Yes** at the end takes you back to the counting menu.

By contrast with the counting menu without CONTAFILL 2, the counting menu with CONTAFILL 2 contains additional information in the third row about the chosen operating mode and the associated set value.

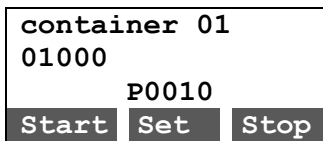

Start the count with **Start**.

### 7.5.2 CONTAFILL 2 – manually rotating the filling position

In the **turn** submenu you can rotate the carousel with ++ by in each case one position further. This is necessary in order to achieve a specific carousel removal position, or to remove or replace a bag/bottle.



<- takes you back to the counting menu.

### 7.6 Switching on/off the acoustic warning signal

In the **beep** menu item you can establish whether or not a warning sound should be made in the case of an error (missing drawer, dirt, empty feed container etc.).

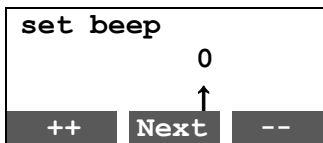

You can change the set value with ++ and --.

1	Beep on
0	Beep off



Confirm your entry with **Yes**.

### 7.7 The hidden settings

To call up the hidden settings, select the **Code** menu item and set the code number **700**.

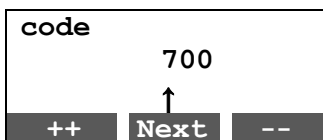

**7.7.1 Setting the display (illumination, brightness and contrast)**

Call up the hidden settings (refer to **chapter 7.7**).

Under the **display** submenu item, you will find the setting options for illumination, brightness and contrast.

To switch on/off the illumination of the display, select **lighting onoff** and then press **Set**.

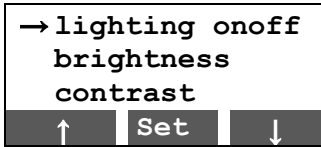

The brightness of the display can be adjusted with ++ and -- in 20 % steps.

<- takes you back to the counting menu.

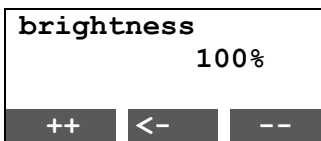

The contrast of the display can be adjusted with ++ and -- in 3 % steps.

**Set** takes you back to the counting menu.

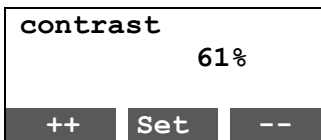

**7.7.2 Selecting the language**

Call up the hidden settings (refer to **chapter 7.7**).

With **Set** select the submenu item **language**. The left-hand side displays the current set language - version, and on the right-and side you can use **Next**, ++ and -- to select the languages German, English and French. Confirm your entry with **Yes**.

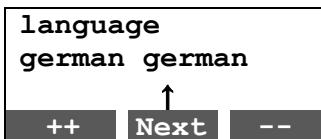

**7.7.3 Container parameter menu**

---

<b>NOTICE</b>	<p><b>You should not change any of the values here!</b></p> <p><b>This will overwrite the factory settings!</b></p> <p>If you want to set different values for a container, then contact the Pfeuffer GmbH.</p>
---------------	-----------------------------------------------------------------------------------------------------------------------------------------------------------------------------------------------------------------

---

**8 Maintenance and cleaning**



The Maintenance and cleaning chapter is only intended for **specialist operators**.

**NOTICE**

Opening the housing and inappropriate operation will invalidate the warranty.

To ensure trouble-free operation, it is essential for the CONTADOR 2 to be cleaned and maintained at regular intervals.

**! DANGER**



**Touching live parts can be fatal!**

It is essential to comply with the switch-off procedure before cleaning, maintenance or repair work! (See **chapter 2.8**)

- ⇒ During all work that is required, wear personal protective equipment according to the company health and safety regulations.
- ⇒ Pay attention to local statutory accident prevention regulations!



The times for carrying out cleaning and maintenance work are based on one-shift working (8 hour/day, 22 days/month, 12 months/year).

<b>d</b> =	Daily	$\frac{1}{4}$ <b>y</b> =	Every three months
<b>w</b> =	Weekly	$\frac{1}{2}$ <b>y</b> =	Every six months
<b>m</b> =	Monthly	<b>y</b> =	Every year



⇒ Unplug the mains plug before you perform any cleaning or maintenance work.

**8.1 Cleaning**

**NOTICE**

Do not use any sharp objects or tools for cleaning. Only use objects that are expressly intended for this purpose.

During cleaning work, wear personal protective equipment according to the company health and safety regulations.

During cleaning, make sure that no water, steam or dust can penetrate the electronics area.

**8.2 Cleaning in the case of a dust warning**

If the error **DEFAULT DIRT 2** is displayed in row 1, then there is dirt on the light barrier (dust or hull). The count is interrupted

<b>DEFAULT DIRT 2</b>	
01000	00520
8	
<b>Start</b>	<b>Set</b>   <b>Cont</b>

The number at the end of row 1 shows which laser is soiled.  
The left light barrier is allocated number 1, the right light barrier number 5.

In the example, the second laser from the left is soiled.

In row 3, the figure 8 indicates a soiled laser. The 8 is shown in one of the first five columns. If it is shown in column two, then the second laser from the left is soiled.

To remove the dirt from the light barrier, it usually suffices to blow a brief, dry shot of air into the light barrier in the direction of fall of the product to be counted (e. g. using a pressurized air can or compressed air).

If this does not work, then you can also clean the light barrier using a narrow, soft brush.

You can prevent soiling on the light barrier by making sure that the external air pump is always closed during operation (refer to **chapter 6.2**). This makes sure you have a continuous air supply across the light barrier.

 **CAUTION**



**Warning about laser radiation!**

In the CONTADOR 2, only a small, diffused beam is emitted through the installed light barriers.

The installed lasers have class 1 – laser radiation harmless in accordance with DIN EN 60825-1 2008:5

Observe the die laser radiation accident prevention regulations BGV B2!

**8.3 Inspection intervals and functional check**

Component	Interval for one-shift operation				
	w	m	¼ y	½ y	1 y
Normal functional checks:					
Check function keys			X		
Labels & warning Notes are available and legible (by visual check)				X	
Check all plug-in, screw-in and clamp connections for firm fit, tighten if necessary			X		
Check the protective covering for faults					X
Check the display functions (illumination, brightness, contrast)					X
Check the beep					X
Check the air pump					X
Perform an electrical check in accordance with VDE	See DGUV regulation 3				

**8.4 General maintenance information**

Checks	Interval
Check the correctness and firm fit of the protective panels.	m
Check the correct positioning of the lasers (refer to <b>chapter 8.5</b> )	m

### 8.5 Check the positioning of the lasers by means of a laser test

The light barrier in the CONTADOR 2 consists of five individual light barriers. Each one has a line sensor that is illuminated by a line laser. In an ideal scenario, the light line illuminates the sensor line centrally and horizontally.

Call up the hidden control menu and setting menu (refer to **chapter 7.7**).

With **Set** select the submenu item **laser test**.

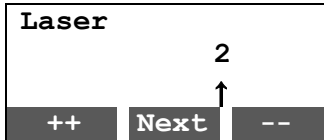

You can now select the lasers 1 to 5 (1 = left lasers; 5 = right lasers) with ++, --, and select **Next** and then confirm your selection with **Yes**.

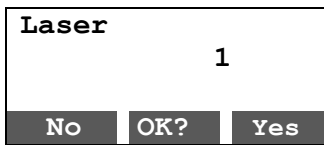

This shows how well the laser is positioned. The display symbolically shows in row 1 and 2 the illumination of the sensor lines by the laser with "+" and "-".

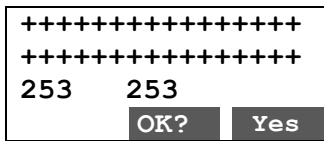

+	Illumination of section in order
-	Illumination of section insufficient

If the laser is correctly positioned, only "+" is displayed in rows 1 and 2 and both count values in row 3 are 253 and 253.

The difference between the two count values should not be more than three.

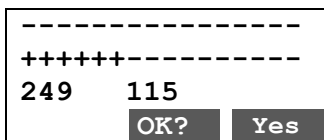

In the case of an off-centered and slanted laser, alongside "+" you will also see "-" in rows 1 and 2. The difference between the two count values is more than three.



A "-" is also shown if the light barrier is soiled. First of all, check and clean the light barrier, refer to **chapter 8.2**.

If cleaning does not remedy the situation, please contact the Pfeuffer GmbH.

### 8.6 Renewing the equipment fuse

There is a round fuse holder in the rear panel. A glass microfuse (1 A T 250 V, 5x20 mm) is incorporated in this. Item number see in **chapter 10**.

**NOTICE** Always refer to the type plate for the precise fuse rating!



⇒ Switch off the CONTADOR 2 using the main switch and disconnect the mains plug from the electrical power supply.

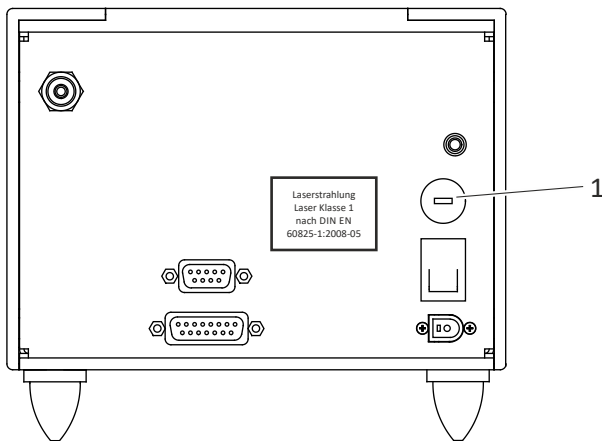

Figure 31: Machine rear panel – Renewing the equipment fuse

Pos.	Name
1	Fuse holder

- ⇒ Unscrew the fuse holder with a slotted screwdriver.
- ⇒ Pull out the fuse holder.
- ⇒ Renew the glass microfuse.
- ⇒ Insert and secure the fuse holder firmly again.
- ⇒ The CONTADOR 2 is ready for operation.

### 8.7 Checks

After work has ended, check:

- ⇒ the completeness of the work that has been carried out.
- ⇒ If all the functions fault-free, the machine will deliver to the operator.

**NOTICE** After cleaning and maintaining, check to see that all the safety equipment is functioning.



**9** Faults – causes and remedy



The information provided in this chapter about possible malfunctions is structured to be understood by specialists in electrical, electronic or mechanical maintenance.

Appropriate tools and test instruments must be provided to these personnel.

If the specified measures do not prove successful, contact Pfeuffer GmbH.

It is important for all questions to specify the correct type designation, serial number and year of manufacture. Only in this way will rapid processing be possible.



It is essential to comply with the switch-off procedure before cleaning, maintenance or repair work! (See **chapter 2.8**)

Problem	Cause	Remedy
The default dirt message ( <b>chapter 8.2</b> ) does not disappear after the light barrier has been thoroughly cleaned.	The laser is no longer in the correct position.	Perform a laser test ( <b>chapter 8.4</b> ) and contact the Pfeuffer GmbH
Count won't start.	Missing feed container and/or drawer.	Position a container and/or insert the drawer.
The count won't start and the display shows the message that no drawer is inserted, even though a drawer is inserted.	The magnet at the rear end of the drawer has fallen off.	Affix the magnets (pos. 1) using superglue in the necessary place.  
When filling with the CONTAFILL 2, no grains arrive in the bag or bottle.	The outlet pipe in CONTAFILL 2 is blocked.	Remove the insert from the outlet pipe, see <b>chapter 7.5</b> .

Figure 32: Drawer - magnets



When contacting us with complaints or queries, please always quote the software versions of the various boards of the CONTADOR 2.

The versions can be called up under the **version** menu item.

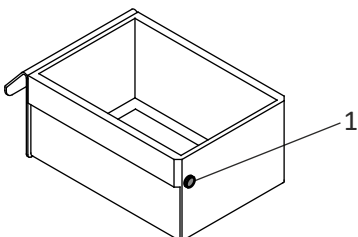
Example:

<b>B</b>	03.07.13	
<b>C</b>	09.12.11	
<b>G</b>	17.07.13	
<b>L</b>	20.03.12	<b>OK</b>

**10 Spare parts and accessories**

**NOTICE** We draw your attention to the fact that we will not check or release any spare parts and accessory parts which we have not supplied. In some circumstances, the installation and/or use of such products could therefore have a negative impact on the specified structural properties of the CONTADOR 2.

Pfeuffer GmbH shall not be held liable or any damages resulting from the use of non-original parts and non-original spare parts.

Standard parts can be purchased from specialist shops.

Product	Item number
CONTADOR 2 seed counter	1410 0019
Power supply	3250 8020
Mains cable with rubber connector	2290 0100
Marina 200 air pump	3251 7000
4 mm PVC hose (for air pump)	3234 9905
T-piece for 4 mm hose	3185 4120
Cleaning brush	3190 0027
Glass microfuse 1 A slow-blow, 5 x 20 mm (10x)	3253 0216
Feed container no. 1 for rapeseed and small seeds	2410 0301
Feed container no. 2 for grain	2410 0302
Feed container no. 3 for maize and legumes	2410 0303
Feed container no. 4 for fine seeds	2410 0304
Semi-automatic filling station CONTAFILL 2	1410 0060

*The following articles are available in the standard equipment supplied for the CONTAFILL 2:*

Product	Item number
Carousel for bags and bottles 50 to 200 mm long for 10 filling positions	2410 0502
Connection cable CONTADOR 2 - CONTAFILL 2	2410 2050

*The following articles are available as accessories for the CONTAFILL 2:*

Product	Item number
Stand for storing a carousel, to make it easier to replace the bags	2410 0650
Bags in various sizes available	upon request
"SeedCount" software for automatic processing of count lists and printing out of labels	1410 0320

## 11 Emergency



⇒ In an emergency, disconnect the CONTADOR 2/CONTAFILL 2 from the electrical supply.

## 12 Disassembly and disposal



Disassembly may be carried out only by **specialist personnel**.



⇒ Disconnect the mains plug before you start disassembling.



### Hazardous waste

Oils, cleaning agents, contaminated cleaning tools (brushes, cloths etc.) must be disposed of in accordance with the local directives and whilst complying with the information provided by the manufacturer in the safety data sheets.



The CONTADOR 2/CONTAFILL 2 must be disposed of in accordance with the statutory local environmental regulations (Waste Electrical and Electronic Equipment Directive 2012/19/EU).

