

Artikelnummer Betriebsanleitung: **1410 0091**
Item no. operating instructions:

PFEUFFER

Operating Instructions

Seed Counter

Contador valid from S/N 14181000

Includes semi-automatic filling station

Contafill



Pfeuffer GmbH
Flugplatzstraße 70
97318 Kitzingen
GERMANY
Phone: +49 9321 9369-0
info@pfeuffer.com
www.pfeuffer.com

Revision 8/18.10.2021
Translation of the original operating instructions



These Operating Instructions are a constituent part of the machine and must be available to all operating personnel at all times. They are intended for the operating company of the system, the operating personnel and the specialists who are responsible for the transport, assembly, installation, operation, maintenance, cleaning, disassembly and disposal.

The Pfeuffer GmbH has prepared and reviewed these Operating Instructions with the greatest care. However, no guarantee is made for its completeness or accuracy.

Subject to technical modifications.

Translation

In the event of delivery of subsequent sale to the countries of the European Economic Area (EEA), the operating instructions must be translated into the corresponding language of the country of use. In the event of discrepancies in the translated text, the original operating instructions (German) must be used for clarification, or the manufacturer must be contacted.

Operating instructions in electronic format

The original operating instructions (German) and translations of the original operating instructions can be requested as PDF files by e-mail: doku@pfeuffer.com. Specifying the correct type designation and serial number is important for further processing!

© Copyright

This document is not allowed to be communicated or duplicated, utilised without express permission, which also applies to communicating its content. Offenders are liable to the payment of damages. All rights reserved with regard to patent claims or submission of design or utility patent.

(DIN ISO 16016)

1	Introduction.....	5
1.1	Intended use.....	5
1.2	Declaration of Conformity CONTADOR.....	6
1.3	Declaration of Conformity CONTAFILL.....	7
1.4	Structural features of the danger notes.....	8
1.5	Pictograms in the operating instructions.....	8
1.6	Identification.....	9
2	Safety.....	10
2.1	Installed safety systems.....	10
2.2	Electrical connections.....	11
2.3	Operating and danger areas on the CONTADOR.....	11
2.4	Operating and maintenance personnel.....	11
2.5	Safety measures (to be carried out by the operating company).....	11
2.6	General safety instructions.....	12
2.7	Safety tests.....	13
2.8	Residual dangers in connection with the CONTADOR.....	13
2.9	Switch-off procedure.....	13
3	Technical data.....	14
3.1	CONTADOR.....	14
3.2	CONTAFFILL (optional).....	14
3.3	General data.....	14
3.4	Noise and vibration.....	15
4	Delivery, transport and storage.....	16
4.1	Standard equipment supplied.....	16
4.2	Transport and packaging.....	16
4.3	Temporary storage.....	17
5	Function.....	18
5.1	Overview.....	18
5.2	Functional sequence.....	18
5.3	External controls.....	18
5.4	PC "SeedCount" software (optional).....	19
5.5	Semi-automatic filling station CONTAFFILL (optional).....	19
6	Installation and operation.....	19
6.1	Assembling the CONTADOR.....	19
6.2	Assembling with the CONTAFFILL semi-automatic filling station (optional).....	20
6.2.1	Assembly and loading the turntable.....	21
6.2.2	Modification for bottles.....	22

6.2.3	Inserting the turntable.....	23
6.2.4	Removing the turntable.....	23
6.2.5	Electrical connections	23
7	Operation	24
7.1	Operator panel	24
7.2	Switch on CONTADOR	24
7.3	Filling the sample.....	25
7.4	Start counting	25
7.5	Selecting the feed container	26
7.5.1	Setting the gate height	26
7.5.2	Counting yarrow and chamomile	26
7.6	Settings.....	27
7.6.1	Menu structure.....	27
7.6.2	Grain size (Size/Größe)	28
7.6.3	Counting speed (Speed/Tempo).....	29
7.6.4	Counting modes.....	29
7.6.5	Speed reduction.....	30
7.6.6	Signal tone	30
7.6.7	Changing the RS232 parameters	30
7.6.8	Feed acceleration	30
7.7	Emptying the sample	31
7.8	Switch off CONTADOR	31
7.9	Counting the seed/grain with the CONTAFILL semi-automatic filling station.....	31
7.9.1	Operating mode "Contafill: 1 cycle"	31
7.9.2	Operating mode "Contafill: bags" (continuous operation)	32
7.9.3	Switch display	33
8	Maintenance and cleaning	34
8.1	Cleaning	34
8.2	Cleaning the light barrier.....	35
8.3	Maintenance.....	36
8.4	Inspection intervals and functional check.....	36
9	Malfunctions – causes and rectification	37
9.1	Signal tones	39
9.2	Renewing the internal fuse	39
10	Spare parts and accessories.....	40
11	Emergency.....	42
12	Disassembly and disposal.....	42

1 Introduction

1.1 Intended use

The CONTADOR Seed counter is used to count cleaned seeds such as grain, oil seeds, corn legumes and similar, dust-free products in order to establish, for example, the thousand seed weight.

It is controlled by the function keys which are fitted to the machine and also the RS232 interface, e.g. using the PC software "SeedCount" which is available as an accessory.

The CONTAFILL semi-automatic filling station is required as an accessory for automatically filling the counted seeds into bags or bottles.

The CONTADOR is designed as a portable machine with a power plug for interiors (lab environment).

A private use of the CONTADOR seed counter is not permitted.

NOTICE

The CONTADOR is designed to be used exclusively for the purpose described.

Any use or modification that does not have the prior written approval of the manufacturer shall be considered as improper use. The manufacturer assumes no liability for damage caused by improper use. The operating company is solely responsible for any damage resulting from this.

The CONTADOR may be put into operation only once it has been established that all the safety equipment is functioning.

The machine cannot be used to items made of static plastic parts and dusty products. This can cause the light barriers to become soiled.

The CONTADOR is not suitable for liquid and sticky products.

The CONTADOR is not intended for operation in potentially explosive atmospheres.

The samples that are used for the intended use must be procured by the CONTADOR operating company.

The operating company is solely responsible for the proper handling of these materials and the associated hazards.

The operating company must provide hazard and disposal information.

Intended use includes also the compliance with the Instruction Manual and User's Guide as well as the maintenance and servicing conditions, as specified in these Operating Instructions.

These Operating Instructions do not relieve the operating company of the obligation to develop and to apply independent health and/or safety regulations or safe working processes which are aimed at the requirements of the overall machine, as well as the obligation to monitor their compliance.

1.2 Declaration of Conformity CONTADOR**EC/EU Declaration of Conformity**

In accordance with the Directives

- Machinery 2006/42/EC
- Electromagnetic Compatibility (EMC) 2014/30/EU
- on the restriction of the use of certain hazardous substances in electrical and electronic equipment (RoHS) 2011/65/EU

Manufacturer: **PFEUFFER**

Pfeuffer GmbH
Flugplatzstraße 70
97318 Kitzingen
GERMANY

Phone: +49 9321 9369-0
info@pfeuffer.com
www.pfeuffer.com

This Declaration of Conformity is issued under the sole responsibility of the manufacturer.

Person authorized to compile the technical documents:

Lothar Pfeuffer, General Manager

Product: **Contador** Seed Counter

Item number: **1410 0011**

Serial number: _____

The aforementioned product complies with the requirements of the following harmonized standards:

DIN EN ISO 12100:2011-03+A1:2013 (EN ISO 12100:2010)

DIN EN 61010-1:2020-03 (EN 61010-1:2010+A1:2019)

DIN EN 61000-6-2:2019-11 (EN 61000-6-2:2019)

DIN EN 61000-6-3:2011+A1:2012 (EN 61000-6-3:2007+A1:2011)

DIN EN 61326-1:2013 (EN 61326-1:2013)

EN IEC 63000:2018

In case of modification of the machine not in coordination with us this declaration expires.

Kitzingen, _____

Lothar Pfeuffer, General Manager

1.3 Declaration of Conformity CONTAFILL**EC/EU Declaration of Conformity**

In accordance with the Directives

- Machinery 2006/42/EC
- Electromagnetic Compatibility (EMC) 2014/30/EU
- on the restriction of the use of certain hazardous substances in electrical and electronic equipment (RoHS) 2011/65/EU

Manufacturer:

PFEUFFER

Pfeuffer GmbH
Flugplatzstraße 70
97318 Kitzingen
GERMANY

Phone: +49 9321 9369-0
info@pfeuffer.com
www.pfeuffer.com

This Declaration of Conformity is issued under the sole responsibility of the manufacturer.

Person authorized to compile the technical documents:

Lothar Pfeuffer, General Manager

Product: **Contafill** semi-automatic filling station

Item number: standard design, **1410 0050** high design, **1410 0055**

Serial number: _____

The aforementioned product complies with the requirements of the following harmonized standards:

DIN EN ISO 12100:2011-03+A1:2013 (EN ISO 12100:2010)

DIN EN 61010-1:2020-03 (EN 61010-1:2010+A1:2019)

DIN EN 61000-6-2:2019-11 (EN 61000-6-2:2019)

DIN EN 61000-6-3:2011+A1:2012 (EN 61000-6-3:2007+A1:2011)

DIN EN 61326-1:2013 (EN 61326-1:2013)

EN IEC 63000:2018

In case of modification of the machine not in coordination with us this declaration expires.





Kitzingen, _____

Lothar Pfeuffer, General Manager









1.4 Structural features of the danger notes

The operating instructions from Pfeuffer GmbH contain instructions that you must comply with for your personal safety as well as to avoid damage to property. The instructions for your personal safety are highlighted by a warning triangle.

Comply with the following categories of danger notes and explanations of symbols:

Pictogram 	 SIGNAL WORD
	Type of danger and its source Possible consequence of failure to comply. ⇒ Measure to guard against the danger.
 DANGER	
This is a warning about a highly dangerous situation that will lead to serious or fatal injuries.	
 WARNING	
This is a warning about a dangerous situation that may result in serious or fatal injuries.	
 CAUTION	
This is a warning of a possibly dangerous situation that will lead to slight or moderate injuries.	
NOTICE This is a warning about harmful situations for the product and/or environment.	

1.5 Pictograms in the operating instructions

	Notes of particular importance and/or additional information		Protective earth connection
	Operating instructions binding		Warning
	Unplug the main plug		Warning about electrical voltage
	Disposal with the household garbage is forbidden!		Recycling marking – Supply refuse for recycling

1.6 Identification

The information provided in these Operating Instructions apply only for the machine whose type designation is specified on the title page. The type plate with the type designation can be found on the backside of the CONTADOR. It is important that the correct type designation is specified if queries are made. This will help us to process the query in a quick and efficient manner.

Sample Pfeuffer GmbH type plate:

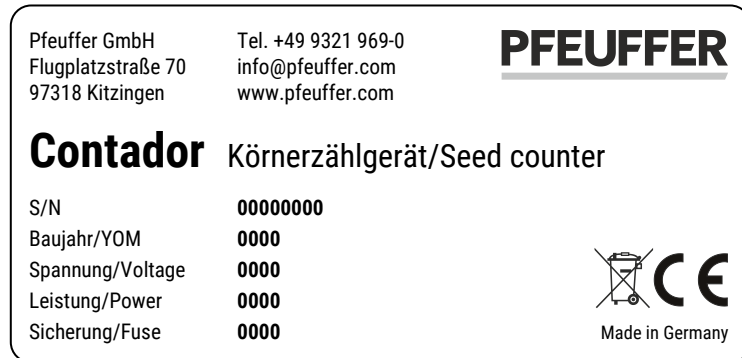

2 Safety

NOTICE It is strictly prohibited to override the safety equipment or to change its function.

2.1 Installed safety systems

The installed safety systems must be checked at regular inspection intervals and using the appropriate inspection methods. Refer to the following table:

Inspection interval	Inspection methods
d = daily	V = Visual check
w = weekly	F = Functional check
m = monthly	M = Measurement
¼ y = quarterly	
½ y = half-yearly	
y = yearly	

Mains switch (plug/socket combination)

Inspection	
Interval	Method
m	V

The main switch **I/O** is the mains disconnecter, and also serves as the EMERGENCY OFF function. It is located on the rear of the device.

The connection for the power cord (IEC 60320 C14 power connector) is on the rear of the device below the main switch.



- ⇒ In an emergency, switch off the CONTADOR using the main switch, position **0**.
- ⇒ Disconnect the power cord from the electrical power supply or disconnect the power coupling (IEC 60320 C13).
- ⇒ Secure the power cord appropriately against unauthorized reconnection by placing it where it can be monitored continuously.
- ⇒ Ensure that the power cord is never a tripping hazard or that someone can become caught or step on it.



Electrical connections, see **chapter 2.2**.



Arrange the plug/socket combination at the place of installation so that it can be observed clearly and reached quickly in an emergency.

Protective coverings

Inspection	
Interval	Method
m	V

The CONTADOR is protected from any intervention in the machine during operation by means of a plastic housing.

2.2 Electrical connections

The CONTADOR must only be operated with the specified voltages. The fuse must always be replaced with identically specified values, see **chapter 3** and the specifications on the type plate.



The device is in protection class I, and may only be connected to a socket which has been grounded in accordance with regulations with a ground wire. The device may only be operated on a power supply that is protected by an RCCB (**R**esidual **C**urrent operated **C**ircuit **B**reaker).

2.3 Operating and danger areas on the CONTADOR

Operating area

Make sure the installation height is sufficient (according to the stature of the operating personnel). A suitable base (e.g. table) is required for this.

Danger area

The entire area one meter around the CONTADOR is a danger area during maintenance and repair work. Keep the area around the CONTADOR clear of objects.

2.4 Operating and maintenance personnel

Operating and maintenance personnel are persons who are responsible for the transport, assembly, installation, operation, setting up and cleaning of the machine and for troubleshooting.

1. The CONTADOR is only allowed to be operated by authorized and instructed people.
2. The responsibilities for operating the CONTADOR must be clearly defined and complied with so that no unclear competencies arise with regard to the aspect of safety.
 1. The switch-off procedures specified in the operating instructions must be complied with during all work (operation, maintenance, repair, etc.), see **chapter 2.9**.
3. The operator must refrain from any working method that impairs safety on the CONTADOR.
4. The operator must ensure that only authorized people work on the CONTADOR.
5. The owner is obliged to report immediately to the owner any changes that take place on the CONTADOR which impair safety.
6. The operating personnel must be provided by the owner with appropriate protective equipment in accordance with legal requirements and the material to be processed.
7. The owner must issue regular instructions regarding the use of personal protective equipment, and must check such equipment is being used.

2.5 Safety measures (to be carried out by the operating company)

We draw your attention to the fact that the operating company must ensure that the operating and maintenance personnel

- ⇒ are instructed about the safety equipment of the CONTADOR
- ⇒ comply with the safety measures.

The frequency of the functional checks as described in **chapter 8.4** must be complied with.

The work described in these Operating Instructions is specified such that

- ⇒ the chapters Function and Operation are understood by the operating personnel
- ⇒ the chapters Delivery, Transport and storage, Installation and operation, Maintenance and cleaning, Faults – causes and remedy and Disassembly and disposal are understood by a **specialist**.

The chapters Delivery, Transport and storage, Installation and operation, Maintenance and cleaning, Faults – causes and remedy and Disassembly and disposal are understood by a **specialist**. The work described in this chapter is intended to be carried out only by **specialists**.

Instructed person

A person who has been instructed and, if necessary, trained by a **specialist** with regard to the duties they are to perform and the possible hazards of any improper conduct; and have been taught about the necessary safety equipment and safety measures.

Specialist

An individual who, on account of their relevant, specialist education, training and/or expertise is capable of detecting risks and avoiding hazards that can arise when using the product.

(Definition in accordance with DIN EN 82079-1:2013-06)

Qualified electrician

Person who is in a position to carry out work on electrical systems and independently recognize potential dangers on the basis of their technical training, knowledge and experience and knowledge of the relevant standards and provisions. Qualified electricians are specially trained for the working environment in which they work and have knowledge of the relevant standards and provisions.

Obligations of the operating company



In the European Economic Area (EEA), the national implementation of the framework directive 89/391/EEC as well as the associated individual directives and, of which, in particular the guideline 2009/104/EC "concerning the minimum safety and health requirements for the use of work equipment by workers at work", in each case in the current version must be observed and complied with.

The local, legal provisions must also be complied with for:

- ⇒ Safety of personnel (accident prevention regulations)
- ⇒ Accident prevention regulation DGUV Regulation 3 (previously BGV A 3) "Electrical systems and equipment" (DGUV = Association of German Statutory Accident Insurance)
- ⇒ Safety of work equipment (protective equipment and maintenance)
- ⇒ The permissible noise load, depending on the location and the time of day (the Technical Rules of the Noise and Vibration Occupational Safety and Health Ordinance – TRLV apply in Germany)
- ⇒ Product and material disposal (waste legislation)
- ⇒ Cleaning (cleaning agents and disposal)
- ⇒ Hazardous substances (in Germany, the technical rules for hazardous substances – TRGS 555 apply)
- ⇒ Environmental protection regulations.

2.6 General safety instructions



The safety equipment and safety instructions described in these Operating Instructions must be observed.



1. In the case of a fault, disconnect the equipment from the mains.
2. Always disconnect the equipment from the mains prior to cleaning.

3. Do not allow the equipment to become wet during transport, storage, cleaning and operation.
4. Ensure that the CONTADOR is used only when it is in perfect condition.
5. Never touch the power cord with wet hands.
6. Use only the original spare parts and accessory parts (refer to **chapter 10**).

2.7 Safety tests

Pfeuffer GmbH carried out the following safety tests at the factory:

Testing and checking according to DIN EN 60204-1:

- Check that the electrical equipment is in compliance with the technical documentation.
- Continuous connection of the protective earth system
- Insulation resistance tests
- Voltage tests
- Protection against residual voltages
- Function tests

The functions of the electrical equipment, in particular those relating to safety and protective measures, have been tested.

2.8 Residual dangers in connection with the CONTADOR

⇒ During all work on electrically operated components, pay attention to dangers from electrical current.

2.9 Switch-off procedure



DANGER

Touching live parts can be fatal!

It is essential to comply with the following switch-off procedure prior to cleaning, maintenance or repair work (only by specialist personnel):

⇒ Empty the CONTADOR.

⇒ Switch off the CONTADOR at the main switch (position **0**).



⇒ Disconnect the power cord from the electrical power supply or disconnect the power coupling (IEC 60320 C13).

⇒ The power cord must be able to be kept under the direct supervision of the person in the danger area.

⇒ During cleaning, make sure that no water, steam or dust can penetrate the electronics area.

3 Technical data

3.1 CONTADOR

Dimensions	430x235x380 mm
Weight	approx. 16 kg
Power supply	115-230 V ~ 50/60 Hz
Power consumption	50 VA
Number of phases	1 Ph / PE
Protective earth conductor	PE (yellow/green) in the power cord
Internal fuse in the main switch	4 A T slow-blow glass microfuse 5x20 mm
Power cord	With removable supply cable (IEC connector cable C13/C14); 10 A, 250 V
Interfaces	RS232 (9-pin DSub socket), CONTAFILL (15-pin DSub socket)
Installation regulation	Configured according to VDE Protection class I / protective earth
Container volumes:	
No. 1 standard design	approx. 450 cm ³
No. 1 high design	approx. 850 cm ³
No. 2 standard design	approx. 450 cm ³
No. 2 high design	approx. 850 cm ³
No. 3	approx. 450 cm ³



Figure 1: CONTADOR

3.2 CONTAFILL (optional)

Dimensions without turntable	Standard design (1410 0050) 480x440x340 mm
Dimensions with turntable	580x440x340 mm
Dimensions without turntable	High design (1410 0055) 480x440x420 mm
Dimensions with turntable	580x440x420 mm
Weight	approx. 16 kg
Weight turntable for bags and bottles	approx. 2.4 kg
Power supply	24 V _{DC} via CONTADOR 15-pin DSub socket

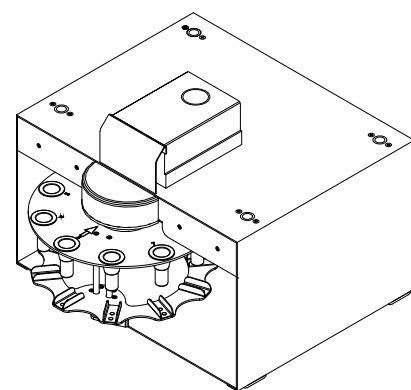

Figure 2: CONTAFILL

3.3 General data

Ambient temperature storage and transport	-10 °C to +60 °C
Ambient temperature operation	+5 °C to +40 °C
Atmospheric humidity	20 % - 80 % non-condensing

3.4 Noise and vibration

Noise level	$L_{PA} < 68 \text{ dB}_{(A)}$ in idle mode (without product in the feed container)
-------------	---



The noise level can increase because of the nature of the product to be counted (e.g. with heavy, hard seeds such as beans and maize) and due to structure-bound noise. Particularly if several seed counters are being operated in the same room at the same time (laboratory environment).

It is the responsibility of the operator to check the noise level on site and then take appropriate measures (produce risk assessment if necessary → wear hearing protection etc.).

4 Delivery, transport and storage



The Delivery, transport and storage chapter is only intended for **specialist operators**.

4.1 Standard equipment supplied

The standard scope of delivery to the owner comprises: CONTADOR Seed counter, feed container of choice, drawer, power cord with IEC connector cable, cleaning brush and operating Instructions. The relevant item numbers can be found in **chapter 10**.

4.2 Transport and packaging

Systems and machines supplied by the Pfeuffer GmbH will be carefully checked and packaged prior to dispatch, however, damage during transport cannot be excluded.

Incoming inspection

Use the delivery note to inspect the completeness.

In the case of damages

Check the delivery for damages (visual check).

In the case of complaints

If the delivery has been damaged during transport:

- ⇒ Keep the packaging (for the freight company to check or for return shipment).
- ⇒ Inform the suppliers or the Pfeuffer GmbH immediately.

Unpacking or Packaging

⇒ In order to avoid damages to the casing and other components, open the packaging:



⇒ Remove the upper packing material.

Figure 3: Remove packing material



⇒ Remove the carton with accessories.

Figure 4: Carton with accessories

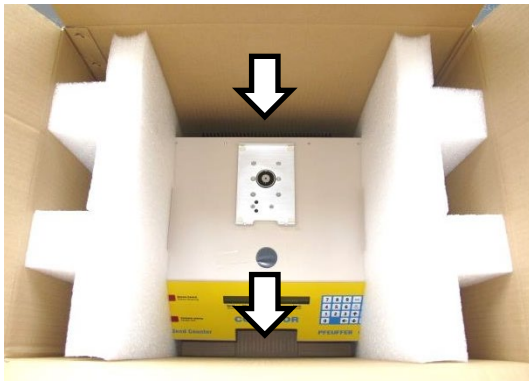

Figure 5: Take out CONTADOR

- The CONTADOR is tightly clamped in the PE foam pads.
- ⇒ Hold down with both hands to grip the CONTADOR from below.
 - ⇒ Carefully lift the CONTADOR out of the box together with the PE foam pads. Pay attention to the weight of 16 kg.

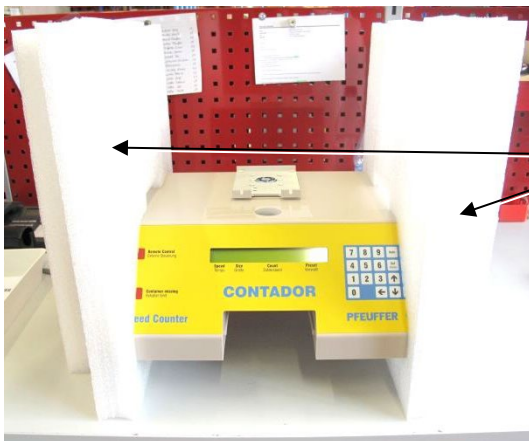

Figure 6: Remove the PE foam pads

- ⇒ Place the CONTADOR on a flat surface.
- ⇒ Carefully remove the two PE foam pads.
- ⇒ Pick up the original packaging for a possible return.
- ⇒ If both are unavailable, request a new packaging from Pfeuffer GmbH.

WARNING



Risk of suffocation

Packaging materials (e.g. film, polystyrene, cardboard boxes) can be dangerous to children.

⇒ Keep packaging material away from children.



⇒ Do not leave packaging material lying around carelessly.

⇒ Dispose of packaging material in an environmentally friendly way.

4.3 Temporary storage

The freight packaging of the CONTADOR and the accessories and replacement parts is designed to be stored for six months as of delivery.

⇒ Do not place heavy objects on the packaging.

Storage conditions

Closed and dry room with a room temperature of min. -10 °C to max. +60 °C.

5 Function

5.1 Overview

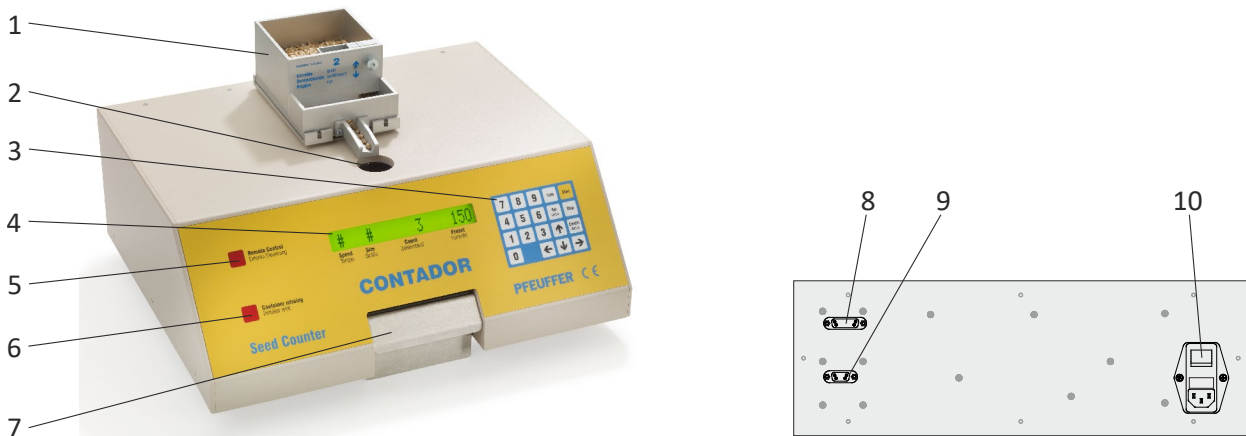

Figure 7: CONTADOR – Components

Rear panel with interfaces

Item	Designation
1	Feed container
2	Inlet funnel with light barrier
3	Keyboard (buttons)
4	LC display
5	Lamp "Externe Steuerung/Remote Control"
6	Lamp "Behälter fehlt/Container missing"
7	Drawer
8	Connection for CONTAFILL connecting cable (15-pin DSub socket)
9	RS232 interface (9-pin DSub socket) for external control
10	Main switch I/O with C13/C14 coupler for the power cord

5.2 Functional sequence

The filled feed container is positioned at the place intended for the CONTADOR. The slider on the feed container is adjusted according to the grain size. The machine automatically detects the feed container (container no. 1 for rape, seeds and fine seeds; container no. 2 for grain, sunflower seeds and rye and container no. 3 for beans, maize and peas) and then loads the optimum parameters for this. Having set the counted quantity, the count starts.

The feed container is held by a magnet and is kept vibrating by means of a vibration element. The vibration causes the product to be counted to flow through the gate of the feed container in the outlet channel. The counting product falls through the photoelectric counting device into the drawer.

Detailed information on operation can be found in **chapter 7**.

5.3 External controls

- **Special interface** (item 8) for connection of the CONTAFILL semi-automatic filling station.
- **RS232 interface** (item 9) for the control of the CONTADOR by means of an external PC, e.g. with the PC software "SeedCount". An evaluation software for your own programming can be provided on request.



Only use the connection cables recommended by Pfeuffer GmbH. Item numbers can be found in **chapter 10**.

5.4 PC "SeedCount" software (optional)

The software enables series of samples to be filled together with the CONTAFILL semi-automatic filling station. You can specify the number of bags and the desired number of seeds. Heterogeneous count lists can be processed in the form of XLS tables. A label printer prints out data such as the test location and number of seeds.

5.5 Semi-automatic filling station CONTAFILL (optional)

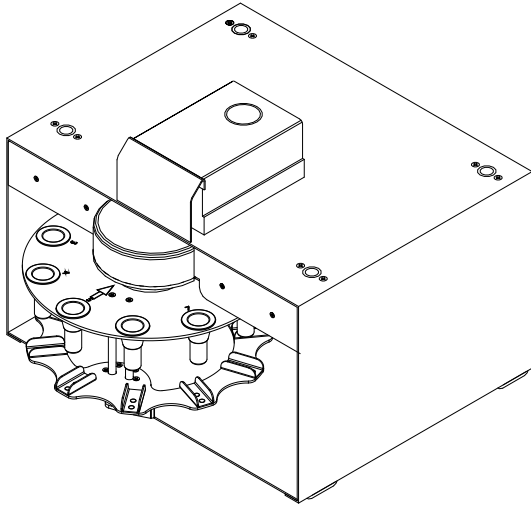

The CONTAFILL semi-automatic filling station is used to quickly fill small batches of seed, grains and similar products (from 10 to 99.950) in bags or bottles.

The CONTAFILL consists of a stainless steel housing with interchangeable turntables for 10 bags or bottles of between 50 and 120 mm in length (with high version of approx. 50 to 200 mm), and installed electronic sensor for detecting the bags. Alternatively, plastic and glass bottles can be filled.

Refer to **chapter 6.2** and **7.9** for more information about assembling and operating the CONTAFILL.

Figure 8: Semi-automatic filling station CONTAFILL (standard design)

6 Installation and operation



The Installation and operation chapter is intended only for **specialists**.

6.1 Assembling the CONTADOR

- ⇒ Carefully unpack the CONTADOR.
- ⇒ Place the CONTADOR horizontally on a solid table with a smooth, clean surface.
- ⇒ Ensure that a firm footing on a non-slip surface is provided.



A correct, horizontal assembly of the machine guarantees an even distribution of the seeds in the outlet channel.

- ⇒ The CONTADOR exerts vibration forces on the base. Do not set up the CONTADOR close to apparatus that are sensitive to vibration.
- ⇒ Make sure there is an adequate distance to all sides so that no heat buildup can occur.



Installation in unheated, draughty and dusty surroundings can have a negative effect on the service life of the CONTADOR.

- ⇒ Avoid exposure to direct sunlight and extreme ambient conditions.
- ⇒ Make sure that the installation height is ergonomic according to the stature of the operating personnel.

- ⇒ Connect the supplied power cord to the CONTADOR using the connector (power connector IEC 60320 C14).
- ⇒ Ensure that the power cord is never a tripping hazard or that someone can become caught or step on it.



⇒ Connect the plug of the power cord to a suitably earthed socket with protective earth conductor.

- ⇒ Position a feed container on the seed counter.
- ⇒ Insert the drawer (without CONTAFILL).
- ⇒ Switch the CONTADOR on at the mains switch (position I).
- ⇒ Observe the information concerning operation in **chapter 7**.

6.2 Assembling with the CONTAFILL semi-automatic filling station (optional)



⇒ Disconnect the power cord of the CONTADOR from the electrical power supply or disconnect the power coupling (IEC 60320 C13) before you start with the installation.

- ⇒ Remove the drawer of the CONTADOR Seed counter.
- ⇒ Place the CONTADOR on the semi-automatic filling station CONTAFILL so that the CONTADOR rubber feet sit exactly in the foot rests of the CONTAFILL.
- ⇒ Connect the CONTAFILL to the CONTADOR using the 15-pin DSub connection cable, see also **chapter 6.2.5**.



Figure 9: Put on CONTADOR and connect with CONTAFILL



Abbildung 10 CONTADOR with filling station CONTAFILL

6.2.1 Assembly and loading the turntable

⇒ Assemble the turntable as shown in the figure below.

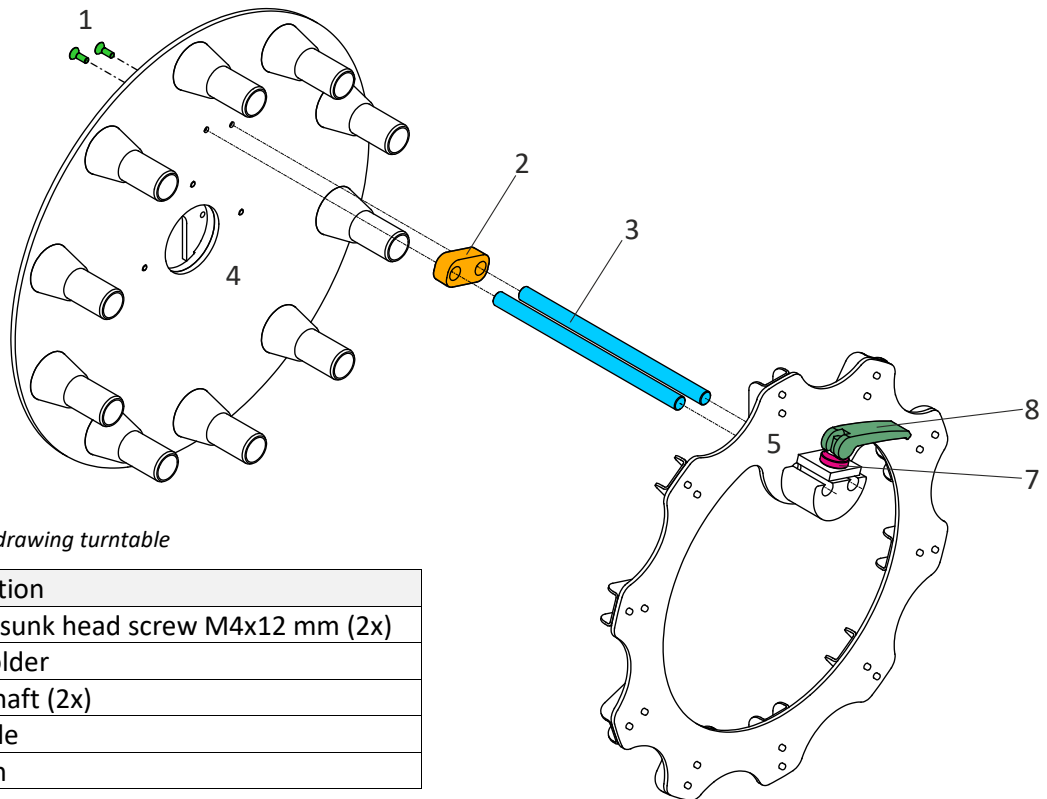

Figure 11: Assembly drawing turntable

Item	Designation
1	Countersunk head screw M4x12 mm (2x)
2	Shaft holder
3	Guide shaft (2x)
4	Turntable
5	Platform

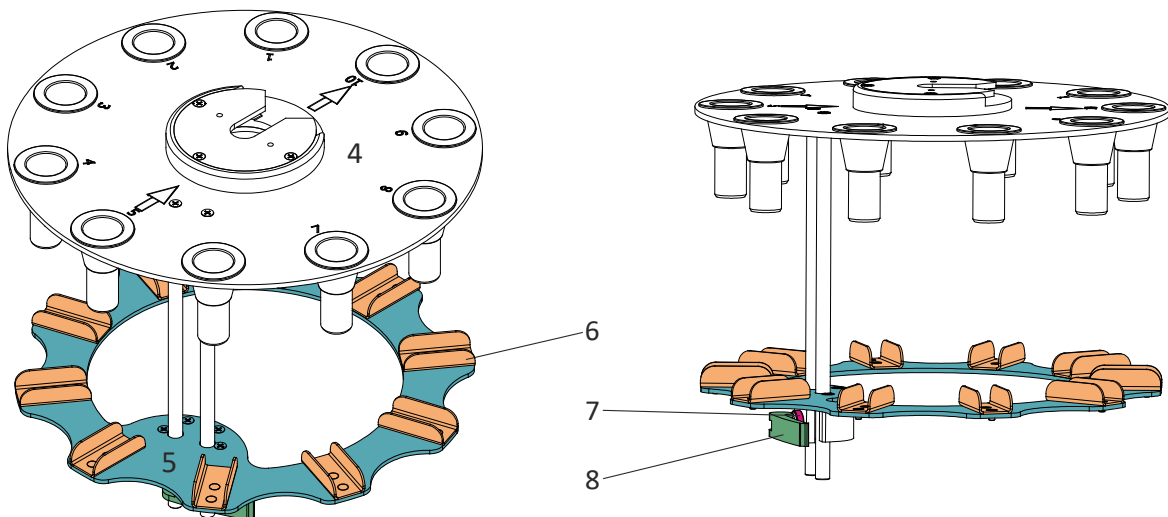

Figure 12: Turntable for bags and bottles

Item	Designation
6	U-shaped holder for bags
7	Knurled nut
8	Eccentric tensioner

⇒ Adjust the height of the platform by loosening the eccentric tensioner and determining the desired height.

⇒ If the adjustment is too loose, tighten the knurled nut on the tensioner tighter.



Figure 13: Loading with bags 11.5x20 cm



Figure 14: Loading with bags 8x12.5 cm

6.2.2 Modification for bottles

The U-shaped holders on the platform are fastened with plastic countersunk expanding rivets.

⇒ Push out the countersunk expanding rivets and keep all individual parts in a safe place.

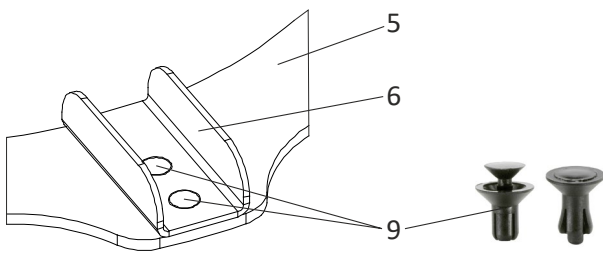

Figure 15: Countersunk expanding rivets

Item	Designation
5	Platform
6	U-shaped holders for bags
9	Countersunk expanding rivets



Figure 16: Platform modified for bottles



Figure 17: Loading with bottles Ø 7.5x16 cm

6.2.3 Inserting the turntable

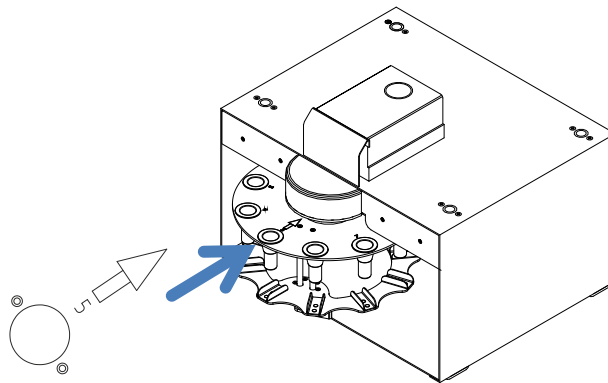

Figure 18: Insert turntable

- ⇒ Carefully insert the turntable in the direction of the embossed arrow (position 5) into the semi-automatic filling station.
- ⇒ Fit in the turntable and turn it shortly into the locking position (left respectively right) until the turntable is locked into place audibly.

6.2.4 Removing the turntable

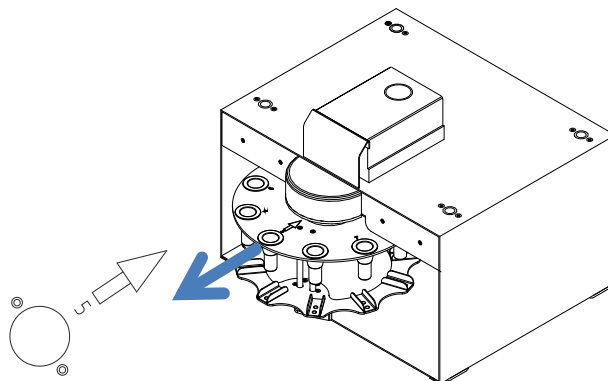
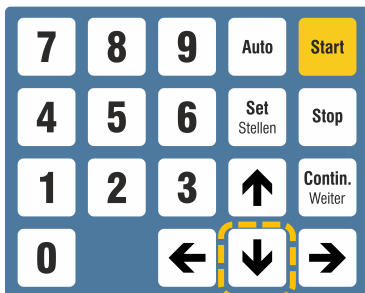

Figure 19: Remove turntable

- ⇒ If you want to remove the turntable again, turn it by the arrow button ↓ on the keyboard of the CONTADOR until the position 5 and the embossed arrow are at the front.
- ⇒ To remove, turn the turntable to the left respectively to the right to loosen the turntable from the locking position.

6.2.5 Electrical connections



The CONTADOR Seed counter in combination with the CONTAFILL semi-automatic filling station may only be connected to a properly grounded socket with protective earth conductor.

NOTICE

The power supply and the control of the CONTAFILL semi-automatic filling station is only possible in connection with the CONTADOR Seed counter.

Do not connect external voltages.

To avoid disturbances or damage to the electronics, the CONTADOR Seed counter must be switched off before disconnecting or inserting the connector.

The connectors of the 15-pin DSub connection cable must always be secure and screwed.

7 Operation



The CONTADOR may be operated only by qualified and trained operating personnel.

7.1 Operator panel

The CONTADOR is operated via the operator panel and the LC display on the front of the device.

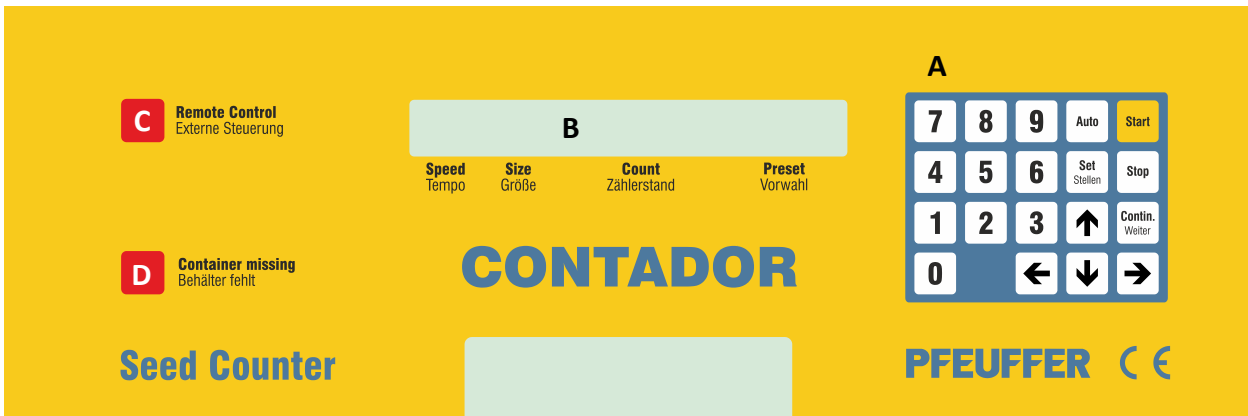

Figure 20: Operator panel

Item	Designation
A	Keyboard
B	LC display
C	Lamp "Remote Control/Externe Steuerung"
D	Lamp "Container missing/Behälter fehlt"

7.2 Switch on CONTADOR

Switch on the CONTADOR via the main switch position I on the back of the device. The system message e.g. HW 2 SW 1.18 (HW = hardware version, SW = software version) is displayed in the LC display for 2 seconds, followed by the operation indicator # # 0 0 with the values for speed, size, count and preset.

The # sign indicates that speed and size regulation are set automatically.

LC display

In standard operation, the following settings are displayed:



- Speed/Tempo = Counting speed
- Size/Größe = Grain size in mm
- Count/Zählerstand = Count
- Preset/Vorwahl = Count preset

Luminous fields



This lamp is active, if

- the remote control of the instrument via RS232-interface or special interface is carried out. Operation via the keyboard is then blocked.
- the CONTAFILL semi-automatic filling station is connected.



This lamp is active, if

- the feed container or drawer is missing.
- there is no bag in front of the sensor (in connection with the CONTAFILL semi-automatic filling station).

The count start is then blocked.

7.3 Filling the sample

After the CONTADOR is switched on via the main switch position I, the counting menu starts.

- ⇒ Place the desired feed container on the CONTADOR.
- ⇒ Make sure the area is clean.

The CONTADOR automatically detects the feed container. Refer to **chapter 7.5** for selecting the container.

- ⇒ Insert the drawer.
- ⇒ Fill the desired seed in the feed container.



Adjust the slider or the gate height according to the grain size, see also **chapter 7.5.1**.

7.4 Start counting

To start a count, it is only necessary to set the preset.

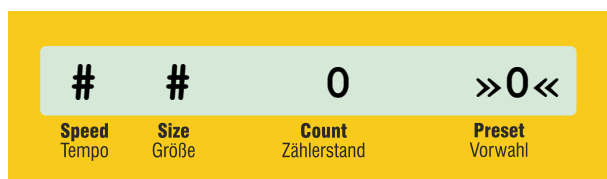

- ⇒ The setting mode is switched on with the **Set** button. The field for the preset starts to flash.



- ⇒ Use the buttons **0** to **9** to set the value for the preset, e.g. 100.



- ⇒ To exit the setting mode, press the button **Stop**. Your settings are accepted. The input field is not flashing any longer.

- ⇒ Press the **Start** button to begin counting.

7.5 Selecting the feed container

The positioned feed container is detected automatically. The bottom of the containers are provided with aglets which are used to detect the container number, and the associated parameters for speed, light barrier and feed are selected automatically.

You can choose from three different feed containers:



Figure 21: Feed container

Item	Designation
1	Container no. 1 for rape, seeds and fine seeds
2	Container no. 2 for grain, sunflower seeds and rye
3	Container no. 3 for maize, beans and peas

7.5.1 Setting the gate height



The counting speed is influenced, among other factors, by the set gate height. It must be adapted to the size of the product to be counted. Adjust the gate height with the adjusting wheel on the container.

The gate height is set correctly, if

- with a full feed container and continuous counting all the channels are evenly filled
- there are no large gaps
- the product to be counted is not adjoining each other and does not jump.

Figure 22: Flow of the seeds into the channel Start the count and observe the flow of the seeds.

7.5.2 Counting yarrow and chamomile

For the counting of yarrow and chamomile you need a special feed container (feed container no. 1 with additional slider), item number see **chapter 10**.

The position of the two sliders no. 1 and no. 2 must be adjusted in order to guarantee the passing of single seeds through the light barrier.

Use a drawer without a rubberized insert, item number see **chapter 10**.

Clean after counting

- carefully the feed container, e. g. blow out with compressed air.
- the outlet with spirit (alcohol), to avoid blockage.

When counting other products (e. g. rape), replace the right-hand slider no. 2 of the feed container no. 1 with the supplied slider no. 3.

7.6 Settings

In order to improve the counting speed or counting accuracy the CONTADOR offers various settings. To start a count, it is only necessary to set the preset. The factory settings can be retained for the other parameters.



The selection of the parameters is done during standstill, i.e. while the device is not counting and the display is not flashing (switching on mode).

User-defined

The factory setting of the CONTADOR is such that the last selected count settings (parameters) are saved when the instrument is switched off and restored when it is switched on again.

The following count settings (parameters) are saved: speed, grain size, preset, count, Contafill bags or 1 cycle, language, counting mode, speed reduction, signal tone, display settings, RS232 parameters

Standard

You can change the selection from "user-defined" to "standard" via the key combination **Set + Set + 3**. All the last selected count settings (parameters) will then not be saved each time the device is switched off.

7.6.1 Menu structure

⇒ Select the parameter with the keyboard combination from the menu structure.

⇒ Use the arrow buttons ← or → to select the various input fields.

The field which is ready for input **flashes** in the display. The menu structure shows you the arrangement of the input fields. The input fields on the right side of **Preset** appear on display only after having been selected.

⇒ Use the arrow buttons ↑ or ↓ to set the desired parameter.

⇒ To exit the setting mode, press the button **Stop**. Your settings are accepted. The input field is not flashing any longer.

You can access the various input fields by means of the specified keyboard combinations:

Keyboard combination	Parameter	Setting with the buttons	Possible settings	Factory settings
	Preset	...	1 ... 99950	0
+	Count	...	0 ... 99950	0
+ +	Size	... ,	3 ... 150 or # for automatic mode	#
+ + +	Speed	... ,	0 ... 99 or # for automatic mode	#
+	Mode		standard, sum, difference	standard

Keyboard combination	Parameter	Setting with the buttons	Possible settings	Factory settings
	Speed reduction		yes, no	yes
	Start		keyboard foot switch	keyboard
	Contrast		0 ... 255	45
	Brightness		0 ... 255	200
			user-defined, standard	user-defined
	Signal tone		yes, no	yes
	Language		Deutsch, english, français	Deutsch
	Contafill		1 cycle, bags	1 cycle
	No. of bags:		0 ... 9999	9999
	Baudrate		150, 300, 600, 1200, 2400, 4800, 9600	9600
	Parity		none, even, odd	none
	Databits		7, 8	8
	Stopbits		1, 2	1

7.6.2 Grain size (Size/Größe)

Keyboard combination: **Set + ← + ←**



Set the slider or the gate height on the feed container according to the grain size, see also **chapter 7.5.1**.

Automatic operation

Automatic mode for size (= #) means, that the instrument partly disregards foreign elements (dust, additions of a smaller diameter), i. e. grains, which are considerably smaller than the product to be counted are not considered. For example, rapeseed in a pea sample falls uncounted into the drawer.

You can switch on automatic operation (= #) using the **Auto + Stop** buttons.

Manual mode

Setting the size of the grains to be counted effects that all grains of maximally half of the preset size are disregarded. The range for the setting of the grain size is from 3 for 0.3 mm up to 150 for 15.0 mm, considering as scale the smallest grains to be counted. Problems may occur with long grains, which cannot always be distinguished from round grains of similar diameter.



Size regulations exceeding the range between 3...150 (= 0.3...15.0 mm) are limited automatically.

7.6.3 Counting speed (Speed/Tempo)

Keyboard combination: **Set** + ← + ← + ←

The CONTADOR selects the counting speed automatically in accordance with the placed feed container and the measured counting impulse. At the same time the counting period and the counting accuracy is optimized. Speed = # means, that the setting of the counting speed is adjusted automatically by the CONTADOR.



Prior to delivery of the CONTADOR, the factory determines container-specific speed values that cannot be exceeded.

The operator can also set a fix speed value manually in the range between 0 up to 99, i. e. 99 % of the maximum possible speed. In this case, however, an optimal time and size regulation is not possible. The counting accuracy can be increased e.g. by reducing the speed.

The manual setting does not allow a speed reduction at the end of the counting (see **chapter 7.6.5**).



In manual input mode, you can also use the arrow buttons ↑ ↓ to adjust the speed within the container-specific values while counting.

You can switch on automatic operation (= #) using the **Auto** + **Stop** buttons.

7.6.4 Counting modes

Keyboard combination: **Set** + →

Standard (= standard counting beginning from 0)

When switched on, the CONTADOR is set to the "standard" mode. There is no symbol between count and preset on the display. After pressing the **Start** button the device starts counting beginning from count **0** (automatic setting to 0 before starting the counting process). The counting mode is indicated by means of the arrow symbol → between count and preset.

When reaching the preset value the feeder is switched off and grains, which are falling through afterwards, are still counted for a period of 0.5 seconds. Then the arrow symbol → disappears in the display.



If the standard counting process is interrupted, it can be continued by pressing the button **Contin.** without resetting the count to zero.

Sum (= to be added to the already existing counted quantity)

This counting mode is indicated by means of the plus symbol **+** between count and preset. After pressing the **Start** button the device continues to count from the existing count value (no automatic reset to zero at counting start). As preset value the sum of the count plus the preset value appear as new value and an arrow symbol **→** instead of the plus symbol **+** appears on the display.

As soon as the calculated preset value is reached the feeder stops (grains, which are falling through afterwards, are still counted for a period of 0.5 seconds) and the plus symbol **+** instead of the arrow symbol **→** appears in the display. As preset value the originally set value appears.

Difference (= to be detracted from the already existing counted quantity)

This counting mode is indicated by means of the minus symbol **—** between count and preset. After pressing the **Start** button the count quantity entered as preset value is detracted from the quantity already counted. As preset value the difference between count minus set preset appears as new value and the arrow symbol **→** instead of the minus symbol **—** is indicated on the display.

As soon as the calculated preset value is reached the feeder stops (grains, which are falling through afterwards, are still counted for a period of 0.5 seconds) and the minus symbol **—** instead of the arrow symbol **→** appears in the display. As preset value the originally set value appears.

7.6.5 Speed reduction

Keyboard combination: **Set + → + →**

Shortly before the counting process is finished the counting speed is reduced in automatic operation (= #) in order to prevent the falling of additional grains. The CONTADOR reduces the speed and counts only the preset quantity of grains. The speed reduction can be switched off by means of the corresponding input field. In this case there will be an exclamation mark "!" in front of the automatic sign # for speed on the display.

7.6.6 Signal tone

Keyboard combination: **Set + Set + 5**

Counting and other operational errors can be indicated by means of an internal signal tone, see **chapter 9.1**.

7.6.7 Changing the RS232 parameters

Keyboard combination: **Set + Set + 6**

For controlling the CONTADOR via the serial interface, baud rate, parity, data bits and stop bits can be changed.

Possible settings:

Baud rate = 150, 300, 600, 1200, 2400, 4800, 9600

Parity = none, even, odd

Data bits = 7, 8

Stop bits = 1, 2

7.6.8 Feed acceleration

When pressing the arrow button **↑** after starting the counting process, the feeding speed is increased in pulses as long as the button is pressed respectively as long as there is no counting product in the container. In this way, the counting material can be shaken loose more quickly or reaches the outlet faster, for example when the feed container is full.

NOTICE

The CONTADOR vibrates very strongly during this process. The counting process is not monitored. Incorrect counts may occur.

7.7 Emptying the sample

- NOTICE** ⇒ Always empty the drawer, bags or bottles completely; otherwise the result of the next count will be corrupted.
- If products are very moist, there is a possibility of condensation buildup, mould or fermentation.
- ⇒ Clean the feed containers, the drawer and the light barrier regularly, see **chapter 8**.
- The operator must provide hazard and disposal information for the products that are used.

7.8 Switch off CONTADOR

The CONTADOR is switched off via the main switch position **0** on the back of the device. The display goes out.

7.9 Counting the seed/grain with the CONTAFILL semi-automatic filling station

Assembly of the CONTADOR with the semi-automatic filling station CONTAFILL see **chapter 6.2**.

An electronic sensor enables the machine to automatically detect whether or not a bag or bottle is positioned in the filling position of the turntable. If no container is located at the appropriate position, the turntable rotates automatically by one position without losing the product to be counted.

Fill the inserted turntable with bags or bottles. You can use the arrow button **↓** to turn the turntable further by one more position.

Inserting and loading the turntable see **chapter 6.2.1** to **chapter 6.2.5**.

- NOTICE** When mounting the turntable, make sure that the electronic sensor (spring clip at the rearmost position) is not bent or damaged.
- The functional capability of the CONTAFILL is no longer guaranteed by a defect of the sensor, since the automatic recognition, whether actually a bag or bottle is present, then no longer works.

7.9.1 Operating mode "Contafill: 1 cycle"

The operating mode **1 cycle** is intended for the counting of larger quantities and smaller numbers of bags not requiring a continuous intervention of the operator. After one turntable cycle the filling process stops automatically in order to prevent a repeated filling of the bags.



Figure 23: Stand with turntable for bags and bottles

When the operating mode **1 cycle** is selected, a turntable with full bags can be removed from the CONTAFILL and a second turntable with empty bags inserted. The filling process can be continued while the full bags from the first turntable are being removed and it is then provided with empty ones for the next pass. The stand, which is available as an accessory, makes this process a lot easier.

- ⇒ Select the required quantity per bag or bottle in the CONTADOR menu:
 Press once on the **Set** button and enter the desired quantity e.g. 100 using the keyboard. Press the **Stop** button to exit the entry.
- ⇒ Select the operating mode in the CONTADOR menu:
 The keyboard combination **Set + Set + 5 + → + →** leads to the display of the operating mode.
 Select the **1 cycle** operating mode with the arrow buttons **↑ ↓**.
 Press the **Stop** button to exit the entry.
- ⇒ Press the **Start** button to start the filling process.

The turntable moves to the next fitted filling position and the CONTADOR starts.

If the CONTAFILL does not find any bags or bottles at the available filling positions it switches off automatically and the message "bag missing" indicates in the display. Confirm this message with the **Stop** button.

The filling process stops automatically after one cycle. After this the number of completely or partially filled bags is indicated.

Example:

full: 6, half: 1

Six bags are completely filled according to the preselection. One bag is only filled partially (e.g. because of an insufficient quantity of materials to be counted inside the feed container).

It is possible to change between count and the reading of the filled bags by means of the arrow button **→** at any time (refer to **chapter 7.9.3**).



Press the **Stop** button to interrupt/cancel the filling process at any time.
 Pressing once means "Pause", pressing twice means "Stop".
 If the CONTADOR is set to "Pause", the filling process can be continued with the **Contin.** button.
 Note that a new filling process will begin after pressing the **Start** button again, i.e. the number of full/half-full bags is reset to **zero**. The turntable moves to the next filling position and a new cycle is started. Already filled bags would be filled again.

7.9.2 Operating mode "Contafill: bags" (continuous operation)

The operating mode **bags** is intended for small quantities and large numbers of bags requiring a continuous placement of empty bags and removal of filled bags by the operator without changing the turntable. The bags are replaced directly on the instrument during the operation.



During this operating mode the repeated filling of the bags must be prevented by the operator.

The filling process is stopped as soon as the preset number of bags is filled during this mode. After switching on the CONTADOR 9999 (= maximum) is preset automatically and this means continuous filling process.

⇒ Select the operating mode in the CONTADOR menu:

The keyboard combination **Set + Set + 5 + → + →** leads to the display of the operating mode.

Select the **bags** operating mode with the arrow buttons **↑ ↓**.

Use the arrow button **→** to jump to the menu **number of bags: 9 9 9 9**.

The desired number of bags can be set with the buttons **0** to **9**.

Press the **Stop** button to exit the entry.

⇒ Press the **Start** button to start the filling process.

The CONTADOR starts and counts the desired number of pieces into the first bag. The bag change can be announced with a signal tone. Setting of the signal tone see **chapter 7.6.6**.

Press the **Stop** button to interrupt/cancel the filling process at any time.

Pressing once means "Pause", pressing twice means "Stop".



If the CONTADOR is set to "Pause", the filling process can be continued with the **Contin.** button.

Note that a new filling process will begin after pressing the **Start** button again, i.e. the number of full/half-full bags is reset to **zero**.

7.9.3 Switch display

All data related to the turntable can be read at any time (even during the filling process). The arrow button **→** leads successively to the indications.

Example:

Contafill: bags **→** number of bags: 9 9 9 9 **→** half: 0, full: 6 **→** # # 35 100 .

The **Stop** button returns to the operating mode at any time, e.g. # # 35 100 .

8 Maintenance and cleaning



The Maintenance and cleaning chapter is only intended for **specialist operators**.

NOTICE Opening the housing and inappropriate operation will invalidate the warranty.

To ensure trouble-free operation, it is essential for the CONTADOR/CONTAFILL to be cleaned and maintained at regular intervals.

! DANGER



Touching live parts can be fatal!

It is essential to comply with the switch-off procedure before cleaning, maintenance or repair work! (See **chapter 2.9**)

- ⇒ During all work that is required, wear personal protective equipment according to the company health and safety regulations.
- ⇒ Pay attention to local statutory accident prevention regulations!



The times for carrying out cleaning and maintenance work are based on one-shift working (8 hour/day, 22 days/month, 12 months/year).

- | | | | |
|-------------|-------------|--------------|--------------------|
| d = | daily | ¼ y = | every three months |
| w = | weekly | ½ y = | every six months |
| m = | monthly | y = | every year |
| ar = | as required | | |



⇒ Disconnect the power cord from the electrical power supply or disconnect the power coupling (IEC 60320 C13).

NOTICE The operator must provide hazard and disposal information for the products that are used.

NOTICE Following cleaning, maintenance or exchanging wearing parts, check that all safety devices are functioning correctly.

8.1 Cleaning

NOTICE Do not use any sharp objects or tools for cleaning. Only use objects that are expressly intended for this purpose.

During cleaning work, wear personal protective equipment according to the company health and safety regulations.

During cleaning, make sure that no water, steam or dust can penetrate the electronics area.

Cleaning	Rectification	Interval
Housing surface	With a clean, dry and lint-free cloth. Clean with a damp cloth in case of heavy contamination.	w
Feed container	With a clean and dry cleaning brush. Clean with a damp cloth in case of heavy contamination.	ar
Drawer	With a clean, dry and lint-free cloth or a cleaning brush. Clean with a damp cloth in case of heavy contamination.	ar
Light barrier	See chapter 8.2 .	ar

NOTICE The **rubberized insert in the drawer must not be removed** in order to avoid any miscounts and impurities of the light barrier!



The Pfeuffer GmbH recommends a complete cleaning or covering of the device before a longer standstill, in order to preserve the operational readiness of the CONTADOR/CONTAFILL.

8.2 Cleaning the light barrier

In case of using dusty or dressed seeds/products, it is necessary to clean the light barrier as required.

- ⇒ Remove the feed container and the drawer.
- ⇒ Carefully place the CONTADOR on its side.



Figure 24: Bottom side of CONTADOR

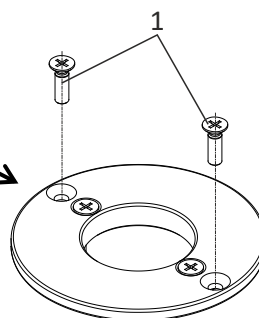
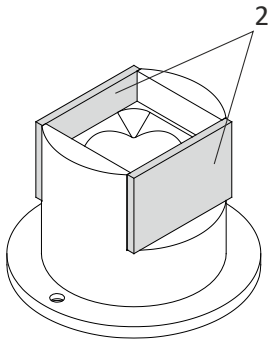

Figure 25: Outlet funnel from below

- ⇒ Unscrew **the two outer countersunk head screws M3x10 mm (item 1)** with a Phillips screwdriver on the outlet funnel on the bottom of the insert slot.

NOTICE Do not unscrew the two internal countersunk head screws to avoid an adjustment of the outlet funnel.



- ⇒ Remove the outlet funnel.
 - ⇒ Clean the light barrier (item 2) and the inside of the outlet funnel carefully with a clean, dry and lint-free cloth.
- Reassemble in reverse order.

Figure 26: Outlet funnel

8.3 Maintenance

Maintenance is a part of servicing and refers to the scheduled cleaning, checking and replacement of wearing parts. The aim of maintenance is to maintain the full functionality of the device over its lifetime. The CONTADOR should therefore be checked for wear and tear at regular intervals. The inspection intervals depend on the frequency of use and the ambient conditions to which the CONTADOR is exposed. Only through regular checks (visual inspection) can damage to the device caused during use be detected early and reliably.

If you are unsure whether your device is still completely ready for use, Pfeuffer GmbH's professional service team will be pleased to assist you.

8.4 Inspection intervals and functional check

Components	Interval for one-shift operations				
	w	m	¼ y	½ y	1 y
Normal functional checks:					
Labels & warning Notes are available and legible (by visual check)				X	
Check all plug-in, screw-in and clamp connections for firm fit, tighten if necessary			X		
Check the correctness and firm fit of the entire machine			X		
Check all cables for damage and aging				X	
Check protective covers for defects, as well as for correct and tight fit		X			
Check keyboard					X
Check display functions					X
Check the beeper					X
Perform an electrical check in accordance with VDE	See DGUV regulation 3				

! DANGER



Damaged cable increase the risk of getting an electric shock!



- ⇒ Never touch a damaged cable (e.g. cable that has been cut into, insulation damaged etc.)
- ⇒ Disconnect the cable from the electrical power supply immediately.
- ⇒ Replace the cable with a new one.

9 Malfunctions – causes and rectification



The information provided in this chapter about possible malfunctions is structured to be understood by specialists in electrical, electronic or mechanical maintenance. Appropriate tools and test instruments must be provided to these personnel. If the specified measures do not prove successful, contact Pfeuffer GmbH. It is important for all questions to specify the correct type designation, serial number and year of manufacture. Only in this way will rapid processing be possible.

**DANGER****Touching live parts can be fatal!**

It is essential to comply with the switch-off procedure before cleaning, maintenance or repair work! (See **chapter 2.9**)

Problem	Cause	Rectification
The display does not light up after switching on.	No mains voltage available. The power cord is not connected securely. Internal fuse in the mains switch defective.	Have the mains voltage checked by an electrician and switched on. Check all connectors for tight fit. Test and replacement by an electrician , see chapter 9.2 .
The device displays e.g. HW 2 SW 1.18 for a longer period of time.	The device has not been switched on properly.	Switch off the device using the main switch. Wait about 5 seconds and turn it back on.
The device does not start after pressing the Start button.	The feed container is missing. The drawer is missing. The electronics may be defective.	Place the feed container on. Place the drawer. Checked by Pfeuffer GmbH.
The device displays: no sample Device stops counting during the counting process.	The device has stopped feeding, because no product is detected for a period of one minute. Mains voltage interference The electronics may be defective.	Fill in counting product. Remove any blockages. Have the mains voltage checked by an electrician . Checked by Pfeuffer GmbH.
The device does not switch off automatically.	Mains voltage interference The electronics may be defective.	Have the mains voltage checked by an electrician . Checked by Pfeuffer GmbH.
The result of the count is wrong.	The speed is too high. The slider on the feed container is set incorrectly.	Reduce the speed. Adjust the slider according to the grain size.

Problem	Cause	Rectification
The result of the count is wrong.	<p>Incorrect manual data input (speed, size)</p> <p>Device does not count correctly.</p> <p>The electronics may be defective or dirty.</p> <p>The bag or bottle was filled several times in continuous operation.</p>	<p>Correct the data.</p> <p>Carry out a test by means of a reference sample.</p> <p>Checked by Pfeuffer GmbH.</p> <p>Keep a void zone, i. e. leave a filling position free.</p>
The display flashes.	The display is still in the setting mode.	Press the Stop button.
The device displays: preset wrong	<p>Preset = 0, preset must be at least 1</p> <p>The preset is > than 99950, it may be max. 99950 with standard counting.</p> <p><u>Counting differences:</u> The preset is bigger than the count.</p> <p><u>Counting sums:</u> The preset plus count is bigger than 99950.</p>	<p>Set a larger preset.</p> <p>Set a smaller preset.</p> <p>Change the preset or count accordingly.</p>
The device displays: container missing or drawer missing	<p>The feed container or the drawer is missing.</p> <p>The connection cable to the CONTAFILL is not connected.</p>	<p>Place the feed container or the drawer.</p> <p>Connect the connection cable CONTADOR ↔ CONTAFILL properly.</p>
The signal tone is on and the device displays grain size 150 .	The grain size > 150 was selected.	Select a smaller grain size.
The device displays: bag missing	The device switches off automatically after it has found 10 times no bag for filling or after 25 seconds.	Place bags or bottles.
The turntable cannot be turned by the arrow button ↓.	<p>The connection cable to the CONTAFILL is not connected.</p> <p>The turntable is not properly locked.</p>	<p>Connect the connection cable CONTADOR ↔ CONTAFILL properly.</p> <p>Insert the turntable correctly, see chapter 6.2.3.</p>
The lamp for Remote Control does not light up after switching on.	The connection cable between CONTADOR ↔ CONTAFILL is interrupted or not connected.	Check that the CONTADOR ↔ CONTAFILL connection cable is connected correctly.



All error messages are confirmed with the **Stop** button, so that the device continues in the work sequence.

9.1 Signal tones

Signal tone:	Short	Long	Double
CONTADOR	Switch on device	Counting process is finished	Container (feed container or drawer) missing!
	Parameter change → signal tone on "yes"		Preset values incorrect
			Count < 0 at difference counting
			Hardware error, e.g. short circuit

Signal tone:	Short	Long	Double
CONTAFILL	Next bag	Last bag	Bag falls down during counting process
			The search for bags is aborted after 10 empty positions or 25 seconds

9.2 Renewing the internal fuse

There is a plug connection in the power switch on the rear panel of the device. An internal glass microfuse is incorporated in this. Item number see **chapter 10**.

NOTICE Always refer to the type plate for the precise fuse rating!



DANGER

Touching live parts can be fatal!

It is essential to comply with the switch-off procedure before cleaning, maintenance or repair work! (See **chapter 2.9**)

 ⇒ Switch off the CONTADOR using the main switch position **0** and disconnect the mains plug from the electrical power supply.

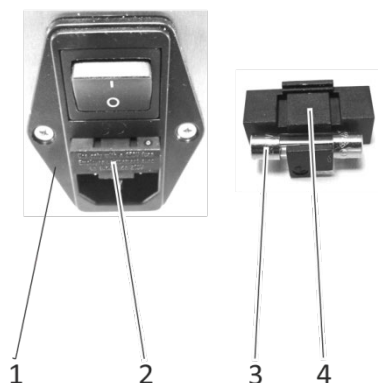

- ⇒ Pull out the plug connection.
- ⇒ Renew the glass microfuse.
- ⇒ Insert the plug connection back into the power switch.
- ⇒ The CONTADOR is ready for operation.

Figure 27: Renewal of the internal fuse

Item	Designation
1	Power switch
2	Pull out plug connection
3	Glass microfuse
4	Plug connection

10 Spare parts and accessories

NOTICE We draw your attention to the fact that we will not check or release any spare parts and accessory parts which we have not supplied.

In some circumstances, the installation and/or use of such products could therefore have a negative impact on the specified structural properties of the CONTADOR/CONTAFILL.

Pfeuffer GmbH shall not be held liable or any damages resulting from the use of non-original parts and non-original spare parts.

Standard parts can be purchased from specialist shops.

The following items are available in the standard equipment supplied for the CONTADOR:

Product	Item number
CONTADOR Seed Counter	1410 0011
Power cord with rubber connector	2290 0100
Drawer	2410 0036
Cleaning brush	3190 0027

The following items are available as accessories for the CONTADOR::

Product	Item number
Feed container no. 1 for rape, seeds, fine seeds	2410 0101
Feed container no 1 in high design	2410 0105
Feed container no. 2 for grain, sunflower seed, rye	2410 0102
Feed container no. 2 in high design	2410 0106
Feed container no. 3 for maize, beans, peas	2410 0103
Feed container no. 3 with special outlet for maize, see figure 28	2410 0104
Special outlet for maize for feed container no. 3, see figure 29	2410 0042
Container increase for feed container no. 3, see figure 31 (item 1-3)	1410 0200
Conversion kit for feed container no. 1 for tomato and pepper (paprika)	3174 4185
Feed container no. 1 with additional slider (for yarrow and chamomile)	Upon request
Feed container for fashion jewelry	Upon request
Glass microfuse 4 A T slow-blow, 5x20 mm (10 pieces)	3253 0228
Rubber feet (stand feet from the device)	3135 0085
"SeedCount" software for automatic processing of count lists and printing out of labels	1410 0320

Product	Item number
CONTAFILL semi-automatic filling station (standard design)	1410 0050
Turntable for bags and bottles approx. 50 to 120 mm long for 10 filling positions	2410 0501
CONTAFILL semi-automatic filling station (high design)	1410 0055
Turntable for bags and bottles approx. 50 to 200 mm long for 10 filling positions	2410 0502
CONTAFILL empty housing (standard height), see figure 31 (item 6)	2410 0700
Connection cable CONTADOR ↔ CONTAFILL 15-pin DSub connection cable, length: 30 cm	2410 2050
Connection cable CONTADOR ↔ PC 9-pin DSub connection cable 1:1 with ferrite core , length: 3 m	2410 1200
USB-to-serial adapter	2820 1522

The following items are available as accessories for the CONTAFILL:

Product	Item number
Various tube holders, see figure 30	Upon request
Stand for storing a turntable, to make it easier to replace the bags	2410 0650
Bags in various sizes	Upon request

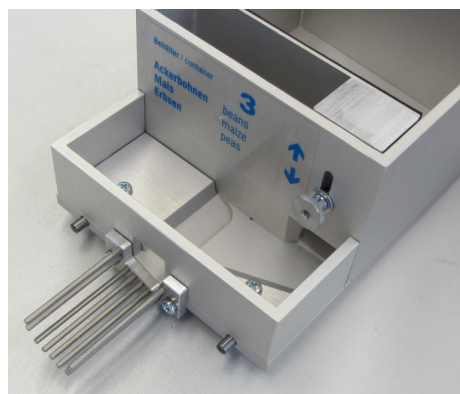

Figure 28: Feed container no. 3 with special outlet for maize



Figure 29: Special outlet for maize



Figure 30: Tube holder

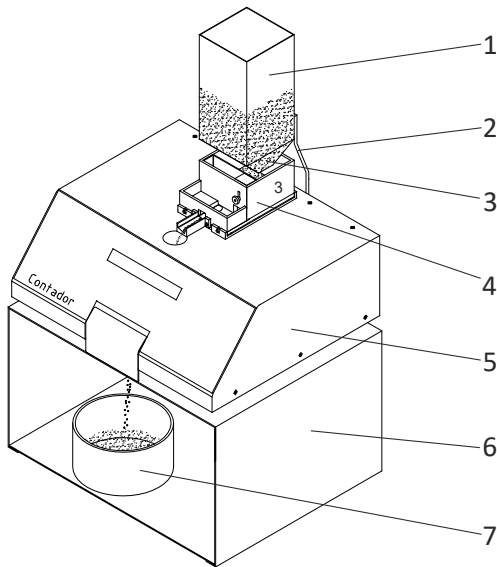

Item	Designation
1	Storing container
2	Clip angle
3	Outlet funnel
4	Feed container no. 3
5	CONTADOR Seed counter
6	CONTAFFILL empty housing
7	Collecting pan

Figure 31: Container increase for feed container no. 3

11 Emergency



⇒ Disconnect the power cord from the electrical power supply or disconnect the power coupling (IEC 60320 C13) in emergencies.

12 Disassembly and disposal



Disassembly and disposal may be carried out only by **specialist personnel**.

! DANGER



Touching live parts can be fatal!

It is essential to comply with the switch-off procedure before cleaning, maintenance or repair work! (See **chapter 2.9**)



⇒ Disconnect the power cord from the electrical power supply or disconnect the power coupling (IEC 60320 C13).



Hazardous waste

Oils, cleaning agents, contaminated cleaning tools (brushes, cloths etc.) must be disposed of in accordance with the local directives and whilst complying with the information provided by the manufacturer in the safety data sheets.



Disposal with the household garbage is forbidden! The CONTADOR/ CONTAFFILL must be disposed of in accordance with the statutory local environmental regulations (Directive WEEE 2012/19/EU).