



**CPE SYSTEMS
INCORPORATED**

PORTABLE PUMPS

HEAT EXCHANGERS

VALVES

HOSES

FITTINGS

AND MUCH MORE

INOXPA Flexible Impeller 30/65 Portable Pump Assembly



Please Contact Us With Any Questions

604 988 7151

sales@cpesystems.com

www.cpesystems.com

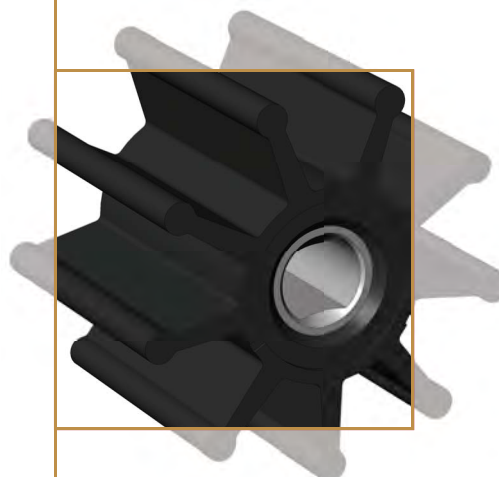

I Application

The RF pump is a flexible impeller pump. Due to the design, these pumps are reversible and self-priming and can suction from a maximum height of 5 meters. This type of pumps is designed to pump products of both low and high viscosity as well as materials containing particles or gases.

The main applications are transfer of dairy products, edible oils, wine, concentrates and beverages in general. They can also be used with viscous food products such as jam and marmalade, custard as well as cosmetic products such as soap, gel, toothpaste and creams. This pump is also used in the dyeing, textile and chemical industries.

I Operating principle

Due to the eccentric shape of the pump housing, a vacuum is created in the suction side that enlarges the volume between the blades and this causes the product suction.

The rotor is spinning and the product is carried from the suction side to that of delivery. Due to the eccentric shape of the pump housing, in the discharge side the blades bend, reducing the volume between them and causing the discharge of the product.

I Design and features

Bare shaft or close-coupled construction.

Reversible and self-priming pump.

Machined investment casting casing.

Double flat drive of the impeller.

Connections DIN 11851.

External single mechanical seal.

IEC motor: B34, 1500 rpm, 3 ph, 230/400 V, 50 Hz, IP55.

Easy maintenance.



I Materials

Parts in contact with the product	AISI 316L
Lantern and bearing support	GG 22
Other parts	AISI 304
Impeller	CR (Neoprene)
Gaskets	NBR
Mechanical seal	Cer/C/NBR
Surface finish	polished, Ra ≤ 0.8 μm



I Options

- SiC/C and SiC/SiC mechanical seals.
- Lip seals.
- Connections: SMS, Clamp, Macon, etc.
- Motors with other protections.
- 1000 rpm motors.
- Electric panel with 10 m cable.
- Stainless steel trolleys.

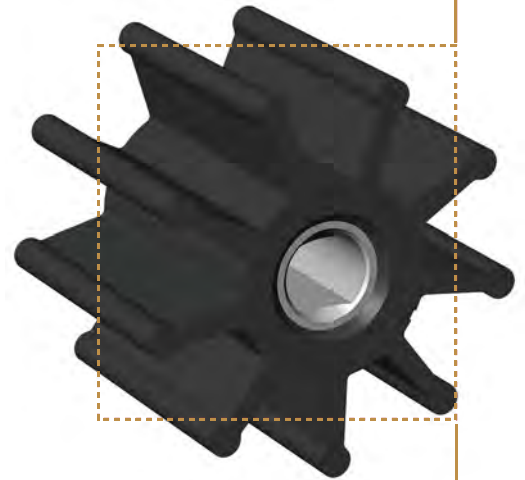

I Technical specifications

Max. flow	28 m ³ /h	132 US GPM
Max. working pressure*	2 - 4 bar	29 - 58 PSI
Max. working temperature	80 °C	176 °F
Max. speed	1450 rpm	

* según modelo

Pump	DN	Flow ⁽¹⁾ [m ³ /h]	Starting torque ⁽²⁾ [Nm]	Reverse torque ⁽²⁾ [Nm]	Maximum differential pressure [bar]		Speed [rpm]
					Close-coupled	Bare shaft	
RF-02/20	25	1,4	4,7	7,1	3	4	1450
RF-05/25	25	4	7,3	13,4	2,5	4	1450
RF-10/40	40	9	15,1	31,6	2,5	4	1450
RF-20/50	50	20	24,4	51,6	2	2	1450
RF-30/65	65	28	64,3	110,5	---	4	1450

(1) Maximum flow for clean non-viscous liquids.
 (2) The use of a frequency drive can cause a decrease of the motor starting torque.

I Dimensions

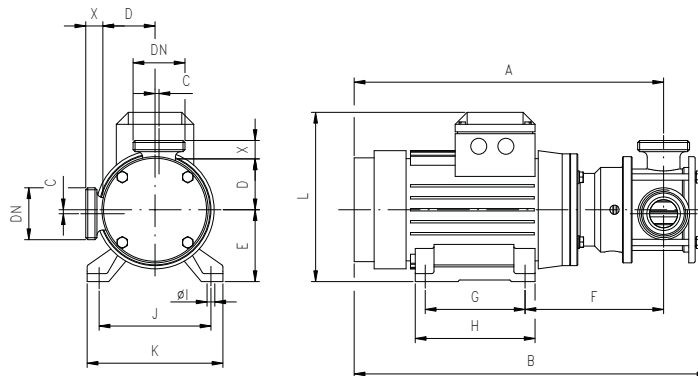

Pump	Motor 1500		DN	A	B	C	D	E	F	G	H	Ø I	J	K	L	X			kg
	Size	kW														DIN	SMS	CLAMP	
RF-02/20	80	0,75	25	330	350	2	51,5	80	139	100	125	9	125	155	220	22	19	12,5	14
RF-05/25	80	0,75	25	340	370	2	55,5	80	148	100	125	9	125	155	220	22	19	12,5	15
RF-10/40	90	1,5	40	410	445	5	66	90	174	125	155	10	140	180	240	22	23	12,5	25
RF-20/50	100	3	50	460	510	6,5	80	100	205	140	180	12	160	200	265	23	23	12,5	37



I Dimensions

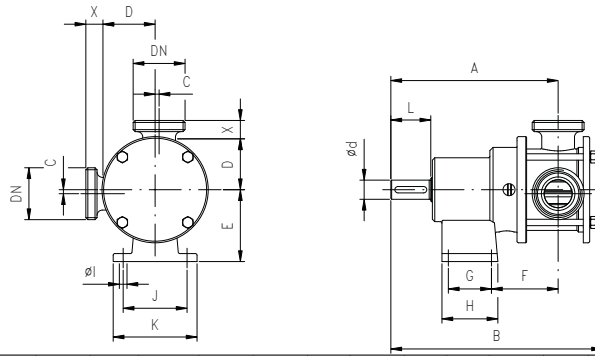

Pump	DN	ød	A	B	C	D	E	F	G	H	ØI	J	K	L	X			kg
															DIN	SMS	CLAMP	
RF-02/20	25	19	172	206	2	51,5	80	74	30	60	9	70	90	40	22	19	12,5	4,5
RF-05/25	25	19	181	225	2	55,5	80	83	30	60	9	70	90	40	22	19	12,5	5
RF-10/40	40	24	210	265	5	66	90	88	45	70	10	80	105	50	23	23	12,5	9
RF-20/50	50	28	272	335	6,5	80	100	109	75	105	11	90	120	60	23	23	12,5	17
RF-30/65	65	28	280	350	10	85	100	117	75	105	11	90	120	60	25	27	12,5	21

I Performance charts

1450 rpm

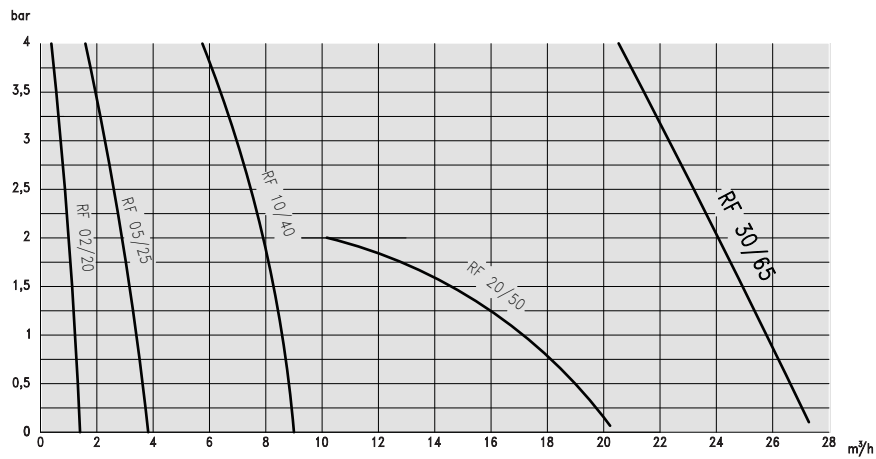

900 rpm

