



CPE SYSTEMS INC

FLEXIBLE IMPELLER

PORTABLE PUMP MANUAL



CONTENTS





CONTENTS.....	2
1. INTRODUCTION.....	3
2. QUICK START GUIDE.....	3
3. KEYPAD GUIDE.....	4
3.1 Layout.....	4
3.2 Drive Operation.....	5
4. LINE INSTALLATION.....	6
4.1 Inlet Line.....	6
4.2 Outlet Line.....	6
5. PUMP CLEANING.....	7
5.1 Clean In Place.....	7
5.2 Cleaning Stainless Steel.....	7
5.3 Preventing Corrosion.....	7
6. MAINTENANCE.....	8
6.1 Disassembly.....	8
6.2 Reassembly.....	8
7. VFD DIGITAL SPEED CONTROL.....	9
7.1 Standard Features.....	9
7.2 Protection Features.....	9
7.4 Specifications.....	11
8. PUMP PARTS.....	12
8.1 Direct Shaft parts.....	12
8.2 Bare Shaft Parts.....	12
9. TROUBLESHOOTING.....	13
9.1 Pumping.....	13
9.2 VFD Error Codes.....	15

1. INTRODUCTION

Thank you for purchasing a CPE Flexible Impeller Pump. Your pump comes completely set up, wired, and pre-programmed. Please read this manual front to back, it includes care instructions for your pump.

2. QUICK START GUIDE

This pump was assembled, wired, programmed, and tested before shipping. It should be ready for use without any modifications or changes required on your part.

1. Connect inlet (suction) line to the Tri-Clamp fitting on the side of the pump using a new Tri-Clamp gasket and a heavy duty clamp. The inlet line should be at least the same diameter as the fitting on the pump. We recommend against clamping a valve or tee onto the inlet port.
2. Connect the discharge line to the Tri-Clamp fitting on the top of the pump using a new Tri-Clamp gasket and a heavy duty clamp.
3. Plug power cord into appropriate wall receptacle using the supplied plug. Do not change the plug or use an adapter, this will void the warranty.
4. Open the valve on inlet line to the pump to allow liquid to flow to the pump.
5. Open the valve on the discharge line if you have one installed.
6. If so equipped, adjust the potentiometer (speed control knob) on front of the digital pump controller to the midpoint so the indicator dot on the knob is at the top.
7. Press the run button  briefly to start the pump.
8. Adjust the speed of the pump by using the up and down arrows   or the potentiometer (if equipped) to obtain your desired flow.
9. When you are finished pumping. Stop the pump by pressing the stop button . Do not stop the pump by simply turning down the speed to zero. This will still allow voltage to the motor and can cause damage and electrical shock.
10. Close both the inlet and discharge valves if equipped.

3. KEYPAD GUIDE

3.1 Layout

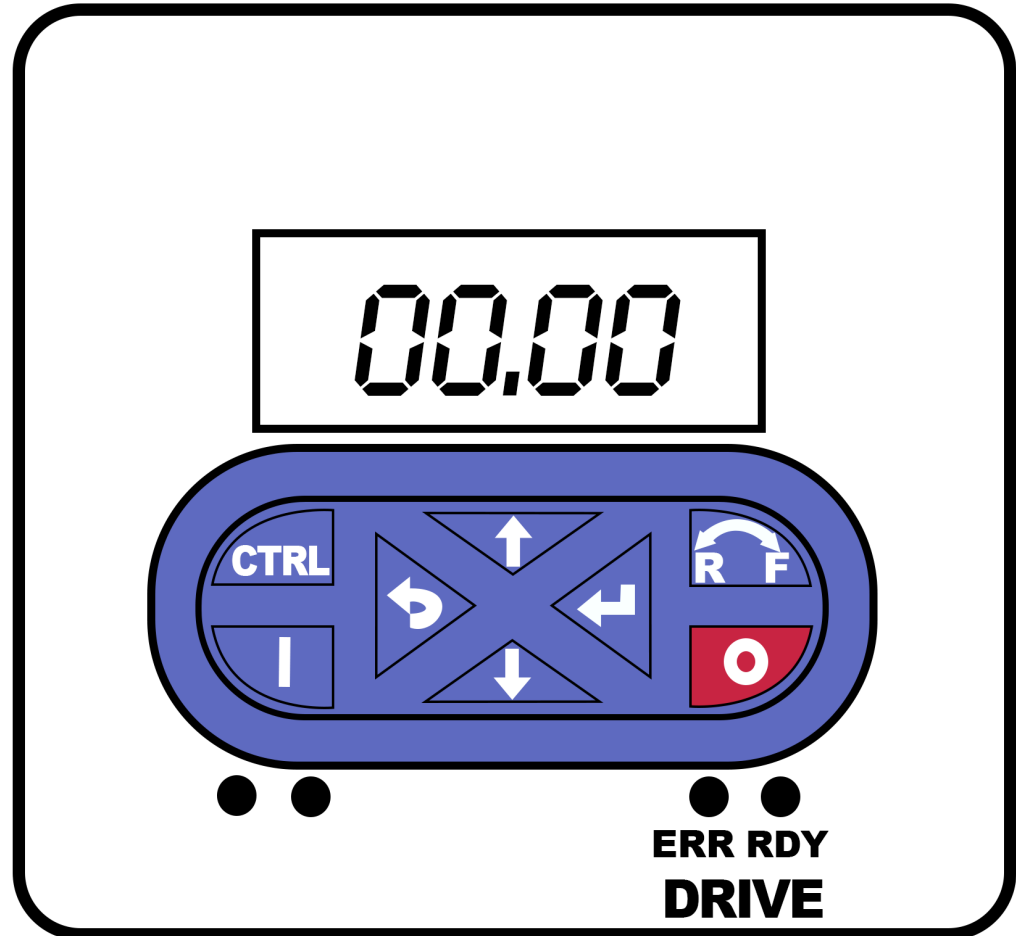

Caution:

Do not assume that your unit is in a power-off state because the LEDs or 4-digit display is off. This does not guarantee a power-off state. Be sure the pump is unplugged or that the main power switch or circuit breaker is in the "OFF" position before servicing the drive.



3.2 Drive Operation















Start-up procedure - Your variable frequency drive has been programmed and all the connections have been completed. To start the drive, press the run button  and use the up key  (or potentiometer, if equipped) to achieve the desired speed. Use the up button  and the down button  to adjust the speed. To stop the pump, press the stop button .

Table 1: Keypad Guide

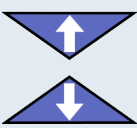
Key	Actuation	Condition	Action
	Shortly	Local keypad control active Display "LOC"	Run motor
		Remote control active Display "REM" Display "KSTOP"	Deactivate keypad triggered stop The motor remains at standstill Display changes from "KSTOP" to "STOP"
	Shortly	No jog operation	Stop motor Display "KSTOP"
	Shortly	Operating mode	Change to parameterization mode > keypad parameterization mode
	More than 3 s	None (anytime possible)	Save parameter settings in the user memory of the memory module
	Shortly	During operation	Scroll through information in the above status line
	Shortly	Manual setpoint selection via keypad active Display "MAN"	Change frequency setpoint
	Shortly	Operating mode	Activate full keypad control Display "ON?" → Confirm with  Control and setpoint selection can now only be carried out via keypad Renewed clicking: Exit full keypad control Display "OFF?" → confirm with
	Shortly	Local keypad control active Display "LOC"	Reversal of rotation direction  Display "REV?" → Confirm with 

4. LINE INSTALLATION

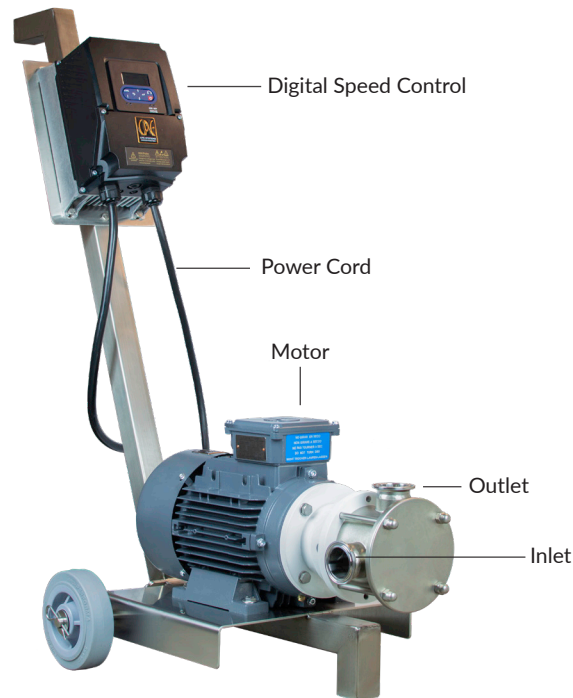

4.1 Inlet Line

The suction line should be short and follow a direct route with a minimum number of elbows and fittings. Elbows should be located as far as possible from the suction inlet to prevent head loss due to increased friction. Excessive friction losses in the suction line could result in pump cavitation, which causes poor performance, noise, vibration, damage to equipment, and possible damage to the product. Whenever practical the diameter of the line at the suction inlet should be increased. An eccentric tapered reducer should be used in lieu of a concentric tapered reducer to prevent air pockets from forming and impairing pump efficiency. The eccentric reducer may be placed at the inlet of the pump and should be positioned so the straight side is up. A horizontal suction line must have a gradual rise to the pump. A high point in the suction line will form an air pocket and prevent proper pump operation. All joints in the suction line should be airtight to prevent air leakage, which can reduce pump capacity and efficiency.

4.2 Outlet Line

The discharge line should be short and direct with a minimum number of elbows and fittings. Elbows should not be used at the discharge outlet as the friction encountered would be increased, resulting in head loss. It is advisable to increase the line diameter at the discharge outlet to prevent head loss. However, the use of a larger discharge line than recommended may reduce the total pump head while increasing the pump volume, which can cause pump vibration due to overload. Use of a discharge pipe smaller than the pump discharge outlet increases the total pump head but decreases the volume. If a reducer is required on the outlet port of the pump and the discharge is vertical, a concentric reducer should be used. If the discharge is horizontal, an eccentric reducer should be used, which should be positioned with the straight side down.

5. PUMP CLEANING

5.1 Clean In Place

Our flexible impeller pumps are designed to be cleaned in place (CIP). No disassembly should be required for cleaning if a proper CIP procedure is followed.

5.2 Cleaning Stainless Steel

Cleaning of stainless steel (AISI 300 Series), manually or chemically, is dependent on the process environment the equipment is operated in. Typically, the cleaning regimen should be developed and reviewed by a plant sanitarian or a formulation representative of a reputable chemical supply company.

The following chemicals may be utilized to clean, passivate, and disinfect equipment prior to operation:

Alkaline Detergent: A blended alkaline detergent may be used to clean equipment. The detergent should be a blended sodium hydroxide/water detergent, designed for use with stainless steel equipment and used at initial concentrations of 1-3% w/w solution at a temperature of 160° F (70° C) to 195° F (90° C) (depending on the chemical supplier). The detergent should be formulated with a metal chelating agent, such as sodium gluconate or gluconic acid, to remove metal ions in the water (hardness dependent) and a surfactant to increase the rinse ability of the solution.

Acid: To neutralize any residual alkali and render a passive surface on the stainless steel, a 160°F (70° C) solution of citric acid and water at a concentration of 0.5-3% w/w can be used. Phosphoric acid may be used at concentrations of 0.5-1.5% w/w at 115° F (45° C). If phosphoric acid is used, corrosion inhibitors should be blended in prior to use.

Disinfectant (Food Plants): Caution should be used with the application of chemical disinfectants. Most chemical disinfectants are halogen or quaternary ammonium-based compounds and, in high concentrations, are very corrosive to stainless steel. Typically, the most common disinfectant, iodophor, can be used with a maximum concentration of 25 mg/l at a maximum temperature of < 80°F (25° C). Other common disinfectants, such as sodium hypochlorite and chloramine, are not recommended.

5.3 Preventing Corrosion

The corrosion resistance of stainless steel is greatest when a layer of oxidation is formed on the surface of the metal. If the protective surface is disturbed or destroyed, the metal can easily be corroded by contact fluids.

1. Regularly inspect stainless steel equipment for surface deposition and/or localized pitting corrosion. If deposition or discoloration is detected, disassemble equipment, remove components and soak in a mild alkaline-based detergent. Rinse using warm water. Allow equipment to air dry thoroughly before assembly.
2. Regularly check all electrical devices and verify all equipment is grounded to avoid any electrolytic-concentration corrosion.
3. Regularly inspect joints and gaskets in the system for crevice corrosion.
4. Regularly inspect equipment for trapped air pockets to avoid pitting caused by oxygen concentration corrosion.
5. Regularly inspect any areas of equipment using dissimilar metals connected by a mechanical joint to avoid galvanic corrosion.
6. Regularly inspect system components not manufactured with stabilized low carbon stainless steel (intergranular corrosion).

6. MAINTENANCE

Caution:

Before servicing pump disconnect electrical power source, carefully relieve all pressure, and drain all fluids from the pump and connected piping.



For flexible impeller pumps, it is not necessary to disassemble if used in a Clean-In-Place installation. In some applications, it may be necessary to disassemble parts of the pump for cleaning and sanitizing. The extent of disassembly will depend on the application and the type of seal used in your pump. It is recommended that periodic inspection of all parts of the pump be made to prevent malfunctions caused by worn or broken parts. Disassembly for repair is the same procedure as for cleaning.

6.1 Disassembly

Disassembly of pump casing, impeller, and mechanical seal

1. Disconnect the inlet and outlet lines.
2. Loosen the blind nuts (45) and detach the pump cover (03).
3. Pull out the casing (01) with the impeller (02).
4. Remove the stationary mechanical seal (08), the o-ring (80), and the tie bars (29) from the casing (01).
5. Remove the rotating mechanical seal (08) and the splash ring (82) from the shaft (05/05A).

Change of drive (monobloc pump) disassembly

1. Loosen and remove the hexagonal screws (52) and the washers (53).
2. Remove the lantern (04) from the motor (93).
3. Remove the pin (56) from the shaft. The pin will need to be drilled or punched out.

Note: Your shaft roll pin will be destroyed in the process of removing the shaft.

4. Remove the shaft (05/05A).

6.2 Reassembly

Note: Reference diagram in section 8 on page 12.

1. Slide the splash ring (82) over the shaft (05/05A), slide past the stop to just above the pin holes.
2. Slide the rotating seal (08) along the shaft (05/05A), spring side facing the bottom of the shaft, to the stop.
3. Lubricate the impeller (02) with food-safe silicone spray.
4. Insert the impeller (02) into the casing by rotating it counter-clockwise. This is a tight fit and it will take some effort to obtain the correct placement.
5. Insert the stationary seal (08) into the casing (01). The black rubber cup should be facing the impeller. The white seal face should be facing out, away from the casing.
6. Gently fit the assembly into the lantern (04) or the bearing support (06) for a bare shaft pump.
7. Place the o-ring (80) on the casing (01) and fasten the tie bars (29).
8. Mount the cover (03) and fasten with the blind nuts (45).

7. VFD DIGITAL SPEED CONTROL

7.1 Standard Features

- Protection level of IP66 (NEMA 4X) with indoor and outdoor approval; dust-tight and approved for use in rough environments.
- Sensorless vector control for synchronous motors.
- Intuitive user interface for fast setup and easy navigation by parameter structure.
- Onboard display with built-in diagnostics.
- Micro USB interface for programming and diagnostics.
- Multiple digital and analog inputs for remote control and safety interlocks.
- Compatible with our wireless remote controls, pressure switches and run-dry protection.
- Full onboard PID programming for interfacing with flow meters, level controls, pressure sensors, and can/bottle fillers.
- Optional front-mounted potentiometer (speed control knob).
- IO-Link compatible (optional).

Note: Your drive has been programmed with the correct settings for optimal performance. Do not change the parameter settings without contacting the manufacturer. This will void the warranty.

7.2 Protection Features

Degree of protection:

- IP66 (EN 60529)
- NEMA type 4X outdoor (NEMA 250)
- UL type 4X outdoor (UL 50E)

Insulation resistance:

- Overvoltage category III (EN61800-5-1) - 0 ... 2000 m amsl
- Overvoltage category II (EN61800-5-1) - Over 2000 m amsl

Isolation of control circuits:

- Safe mains isolation via double/reinforced insulation (EN 61800-5-1)

Protective measures against:

- Short circuit
- Earth fault - earth-fault protected depending on operating status
- Overtemperature of motor - PTC or thermal contact
- Overvoltage
- Motor stalling

Leakage Current: >3.5 mA AC, >10 mA DC (EN 1800-5-1)

Starting Current: $\leq 3 \times$ rated mains current

7.3 Programming

Note: The VFD is factory set for optimal operational efficiency. If you need to make changes please contact our service department for assistance.

All parameters of the VFD can be accessed by means of the keypad for commissioning and diagnostics and are listed in Table 2.

- The keypad parameter list is sorted in ascending order in compliance with the "display code" (Pxxx).
- In order to provide quick access, all parameters of the VFD are divided into different groups according to their function.
- Group 0 contains the configurable "Favourites". In the default setting these are the most common parameters for the solution of typical applications.
- Based on the hundreds digit of the display code (Pxxx) you can quickly see in which group the parameter is to be found on the keypad.

Table 2: Keypad Parameter List

Parameter	Group - Name	Description
P1xx	Group 1 - Diagnostics	Diagnostic/display parameters for displaying device-internal process factors, current actual values, and status messages.
P2xx	Group 2 - Basic setting	Setting of the mains voltage, selection of the control and setpoint source, starting and stopping performance, frequency limits, and ramp times.
P3xx	Group 3 - Motor control	Configuration of the motor and motor control.
P4xx	Group 4 - I/O setting	Function assignment and configuration of the inputs and outputs.
P5xx	Group 5 - Network setting	Configuration of the network (if available).
P6xx	Group 6 - Process controller	Configuration of the process controller.
P7xx	Group 7 - Additional functions	Parameterizable additional functions.
P8xx	Group 8 - Sequencer	The "sequencer" function serves to define a programmed sequence of speed setpoints, PID setpoints or torque setpoints for the motor control. Switching to the next setpoint can be executed in a time-based or event-based manner.

Note: This table is provided for reference only. Please contact customer support before changing any parameters.

7.4 Specifications

Table 3: Technical Data

i550 protec		
Mains	1 AC 120 V	0.37 ... 1.1 kW (0.5 ... 1.5 hp)
	1 AC 230 V	0.37 ... 2.2 kW (0.5 ... 3 hp)
	1/3 AC 230 V	0.37 ... 3 kW (0.5 ... 4 hp)
	3 AC 230 V	3 ... 22 kW (4 ... 30 hp)
	3 AC 400 V/480 V	0.37 ... 22 kW (0.5 ... 30 hp)
	3 AC 600 V	0.75 ... 3 kW (1 ... 4 hp)
Overload Behaviour	Mode S1: 150%, mode S6: 200%	
Interfaces	Digital inputs/outputs (5/1), analog inputs/outputs (2/1) Relay	
	External 24 V supply PTC/thermal contact HTL incremental encoder (100 kHz) USB onboard	
	CANopen, EtherCAT, EtherNet/IP, Modbus RTU, Modbus TCP, PROFINET, IO-Link (optional)	
	Integrated brake chopper DC bus connection	
Conformity and Approvals	CE, UL, CSA, EAC, RoHS2, IE2 in accordance with EN 50598-2	
Functions	V/f characteristic control linear/square-law (VFC plus) Sensorless vector control (SLVC) Energy saving function (VFC eco) Servo control (SC-ASM) with feedback Sensorless vector control for synchronous motors	
	Vector control with feedback V/f V/f characteristic control with feedback	
	DC-injection braking Brake management for brake control with low rate of wear	
	Dynamic braking through brake resistor	
	S-ramps for smooth acceleration and delay Flying restart circuit, PID controller	
	Safety Technology	Safe torque off (STO)

8. PUMP PARTS

8.1 Direct Shaft parts

01. Pump Casing	45. Blind Nut
02. Impeller	52. Hexagonal Screw
03. Pump Cover	53. Flat Washer
04. Lantern	56. Elastic Pin
05A. Shaft	80. O-ring
08. Mechanical Seal	82. Splash Ring
29. Tie Bar	93. Motor

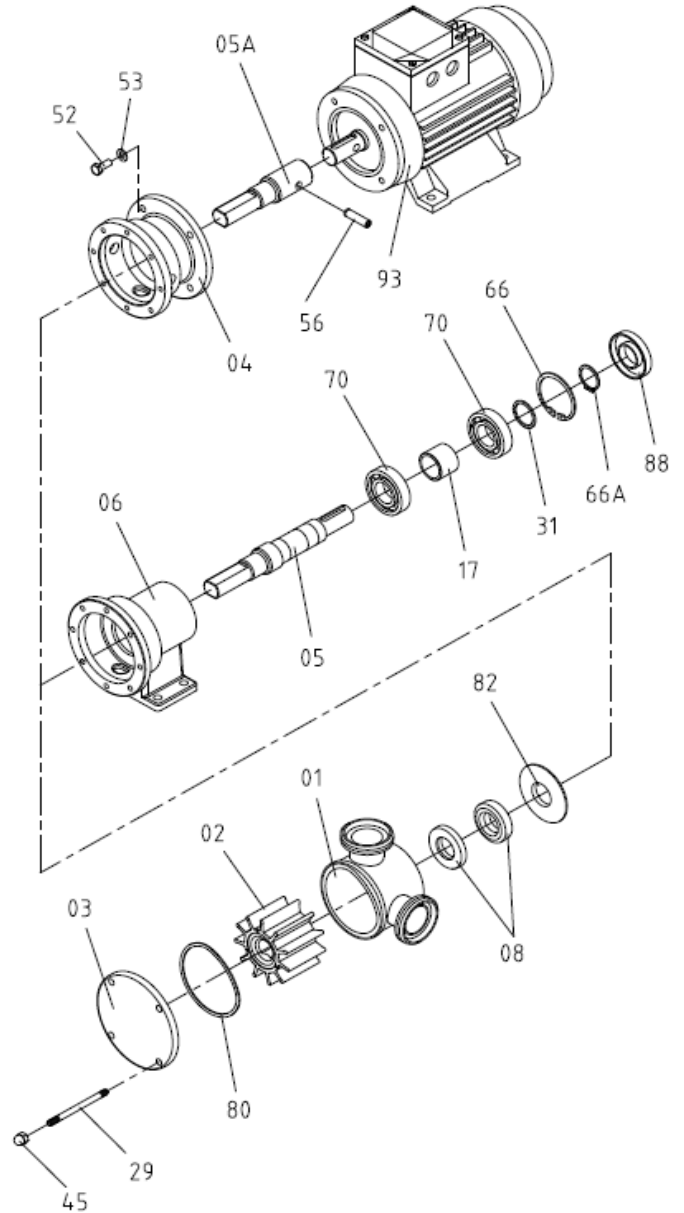

8.2 Bare Shaft Parts

01. Pump Casing	31. Stop Ring
02. Impeller	45. Blind Nut
03. Pump Cover	66. Elastic Ring
05. Shaft	66A. ELastic Ring
06. Bearings Support	70. Bearing
08. Mechanical Seal	80. O-ring
17. Spacer Bushing	82. Splash Ring
29. Tie Bar	88. Seal

9. TROUBLESHOOTING

CPE pumps are relatively maintenance-free with the exception of sanitizing and seal replacement. However, like any piece of machinery occasional problems can arise. This section provides a means of determining and correcting most of your pump problems. The motor manufacturer should be contacted for specific repair instructions on the motor. Table 4 and Table 5 has been prepared on the basis that the pump is properly-suited to its application. Should problems arise where the remedies listed in the following tables do not resolve them, pump cavitation may be the problem. Symptoms of pump cavitation, such as noisy operation, insufficient discharge, and vibration, can result when a pump is not properly applied. If these conditions are present, check the system and re-evaluate the application. If assistance is required, contact CPE Systems.

9.1 Pumping

Table 4: Pump Troubleshooting

Problem	Probable Cause
A. Motor overload	8, 12, 13, 18, 19, 20
B. The pump does not provide enough pressure or flow	1, 2, 4, 5, 7, 8, 9, 15, 17
C. No pressure on the discharge side	2, 3, 6, 16, 17, 21
D. Uneven discharge flow/pressure	1, 2, 4, 5, 6, 8, 21
E. Noise and vibration	2, 4, 5, 6, 7, 8, 9, 12, 13, 14, 18, 19, 20
F. The pump gets clogged	8, 9, 12, 13, 14, 18, 19, 20
G. Overheated pump	8, 9, 12, 13, 14, 18, 19, 20
H. Excessive wear	4, 5, 9, 13, 14, 18, 20, 21
I. The mechanical seal leaks	10, 11

Probable Cause	Solution
1. Wrong direction of rotation	Reverse the direction of rotation
2. NPSH not high enough (Does not apply to RF series pumps)	Place the suction tank higher Place the pump lower Reduce steam pressure Increase the diameter of the suction pipe Shorten and simplify the suction pipe
3. Pump is not drained	Drain or fill
4. Cavitation	Increase suction pressure
5. Air is suctioned by the pump	Check the suction pip and all its connections
6. Clogged suction pipe	Check the suction pipe and all its filters, if any
7. Discharge pressure too high	If necessary, reduce load losses, e.g. by increasing the diameter of the pipe or by including a bypass
8. Fluid viscosity too high	Reduce the viscosity
9. Fluid temperature too high	Reduce the temperature by cooling the fluid
10. Mechanical seal damaged or worn out	Replace the seal
11. O-rings unsuitable for fluid	Fit suitable o-rings, consult the manufacturer
12. Excessive impeller expansion	Reduce temperature Change the impeller
13. Stressed pipes	Connect the pipes to the pump so as to avoid stress
14. Foreign matter in fluid	Fit a filter to the suction pipe
15. Pump speed too low	Increase speed
16. The cut-off valve on the suction side is closed	Check and open
17. Pump too small	Choose a larger pump size
18. Bearings are worn out	Replace bearings, review the pump
19. Misaligned coupling	Align the coupling properly
20. Pump and/or motor not attached to the baseplate	Attach the pump and/or motor and check whether the pipes are connected without stress and align the coupling
21. Impeller is worn out or has operated in vacuum	Replace the impeller

9.2 VFD Error Codes









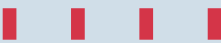





Table 5: VFD Error Codes

Error Code	Description	Classification	Remedy	Blocking Times	Reset Possible
2250	CiA: Continuous overcurrent (inside the device)	Fault	<ul style="list-style-type: none"> Check motor and wiring for short circuit Check brake resistor and wiring Check motor circuit (delta connection, star connection) Check setting of the motor 	5	Yes
2320	Short circuit or earth leakage on the motor side	Fault	<ul style="list-style-type: none"> Check motor cable Check the length of the motor cable Use shorter or lower-capacitance motor cable 	5	Yes
2340	CiA: Short circuit (inside the device)	Fault	<ul style="list-style-type: none"> Check motor cable for short circuit 	5	Yes
2350	CiA: $i^2 \cdot t$ overload (thermal state)	Fault	<ul style="list-style-type: none"> Check drive sizing Check machine/driven mechanics for excessive load Check setting of the motor data Reduce values for slip compensation (P315.01, P315.02) and oscillation damping (P318.01, P318.02) 	5	Yes
2382	Error: Device utilisation (lxt) too high	Fault	<ul style="list-style-type: none"> Check drive sizing Reduce maximum overload current of the inverter (P324.00) In case of high mass inertias, reduce maximum overload current of the inverter (P324.00) to 150% 	3	Yes
2383	Warning: Device utilisation (lxt) too high	Warning	<ul style="list-style-type: none"> Check drive sizing 	0	Yes
3120	Mains phase fault	Fault	<ul style="list-style-type: none"> Check wiring of the mains connection Check fuses 	0	Yes
3210	DC bus overvoltage	Fault	<ul style="list-style-type: none"> Reduce dynamic performance of the load profile Check mains voltage Check settings for braking energy management Connect brake resistor to the power unit and activate the integrated brake chopper (P706.01 = 0: Brake resistance) 	0	Yes
3211	Warning: DC bus overvoltage	Warning	<ul style="list-style-type: none"> Reduce dynamic performance of the load profile Check mains voltage Check settings for braking energy management Connect brake resistor to the power unit and activate the integrated brake chopper (P706.01 = 0: Brake resistance) 	0	Yes
3220	DC bus undervoltage	Trouble	<ul style="list-style-type: none"> Check mains voltage Check fuses Check DC bus voltage (P105.00) Check mains settings 	0	Yes

Error Code	Description	Classification	Remedy	Blocking Times	Reset Possible
3221	Warning: DC bus undervoltage	Warning	<ul style="list-style-type: none"> • Check mains voltage • Check fuses • Check DC bus voltage • Check mains settings 	0	Yes
3222	DC bus voltage too low for switch-on	Warning	<ul style="list-style-type: none"> • Check mains voltage • Check fuses • Check mains settings 	0	Yes
4210	PU: Overtemperature fault	Fault	<ul style="list-style-type: none"> • Check mains voltage • Provide for sufficient cooling of the device (display of the heatsink temperature in P117.01) • Clean fan and ventilation slots. If required, replace fan • Reduce switching frequency (P305.00) 	0	Yes
4281	Heatsink fan warning	Warning	<ul style="list-style-type: none"> • Clean fan and ventilation slots. If required, replace fan. The fans can be unlocked via locking hooks and can then be removed 	0	Yes
4310	Error: Motor overtemperature	Fault	<ul style="list-style-type: none"> • Check drive sizing • Check motor thermal sensor and wiring (X109/T1 and X109/T2) 	5	Yes
5112	24-V supply fault	Warning	<ul style="list-style-type: none"> • Check optional external 24-V voltage supply (terminal X3/24E), if connected • Check mains voltage 	0	Yes
5180	24-V supply overload	Warning	<ul style="list-style-type: none"> • Check 24-V output and digital outputs for earth fault or overload 	0	Yes
6280	Trigger/functions connected incorrectly	Trouble	<ul style="list-style-type: none"> • Check and correct the assignment of the triggers to the functions • With keypad or network control, the two functions "Inverter enable" (P400.01) and "Run" (P400.02) can also be set to "Constant TRUE{1}" to start the motor 	0	Yes
7180	Motor overcurrent	Fault	<ul style="list-style-type: none"> • Check motor load • Check drive sizing • Adapt the set error threshold (P353.01) 	1	Yes
9080	Keypad removed	Fault	<ul style="list-style-type: none"> • Plug on the keypad again or activate another control source 	0	Yes
FF02	Error: Brake resistor overload	Fault	<ul style="list-style-type: none"> • Check drive sizing • Check settings for the braking energy management <p>Note: The error will be reset if the thermal load falls below the error threshold (P70180) of - 20%</p>	5	Yes
FF06	Motor overspeed	Fault	<ul style="list-style-type: none"> • Adapt the maximum motor speed (P322.00) and the error threshold (P350.01) 	1	Yes
FF36	Warning: Brake resistor overload	Warning	<ul style="list-style-type: none"> • Check drive sizing • Check settings for the braking energy management <p>Note: The warning will be reset if the thermal load falls below the warning threshold (P707.08) of - 20%</p>	0	Yes
FF37	Automatic start disabled	Fault	<ul style="list-style-type: none"> • Deactivate start command and reset error 	0	Yes

Table 6: Diagnostics and Fault Elimination

The "RDY" and "ERR" LED status displays on the front of the inverter provide some quick information about certain operating states.

"RDY" LED (blue)	"ERR" LED (red)	Status/meaning
Off	Off	No supply voltage.
		Initialization (inverter is started).
On	On	
 Blinking (1 Hz)	Off	Safe torque off (STO) active.
	 Blinking fast (4 Hz)	Safe torque off (STO) active, warning active.
 Blinking (2 Hz)	Off	Inverter inhibited.
	 Blinking fast (4 Hz)	Inverter disabled, warning active.
		Inverter disabled, error active.
	On	
	 Lit ever 1.5s for a short time	Inverter inhibited, no DC-bus voltage.
	 On for a short time every 1s	USB module is connected, 5-V supply voltage for the USB module is available.
	Off	Inverter enabled.
On		The motor rotates according to the specified setpoint or quick stop active.
	 Blinking fast (4 Hz)	Inverter enabled, warning active. The motor rotates according to the specified setpoint or quick stop active.
	 Blinking (1 Hz)	Inverter enabled, quick stop as response to fault active.
		Firmware update active.
		"Visual tracking" function is active.
		Both LEDs are blinking in a very rapidly synchronous mode

Thank you for reading.

Please contact CPE Systems if you have any questions or concerns not covered in this manual.
We would be happy to assist you in any way possible.

Phone Number (Canada): 604 988 7151

Phone Number (International): +1 800 668 2268

Email: sales@cpesystems.com

Address: 7272 Buller Ave, Burnaby, BC, V5J 4S3, Canada

Website: www.cpesystems.com