

**IFA-3
INSTRUCTION MANUAL**

***BENCHMARK MEDIA SYSTEMS, INC.
5925 Court Street Road
Syracuse, New York 13206-1707
(315) 437-6300 FAX (315) 437-8119***



REVISIONS

A	SEE DCN NO. 56	5/16/89	JRP
B	SEE DCN NO. 112	8/25/89	RAB

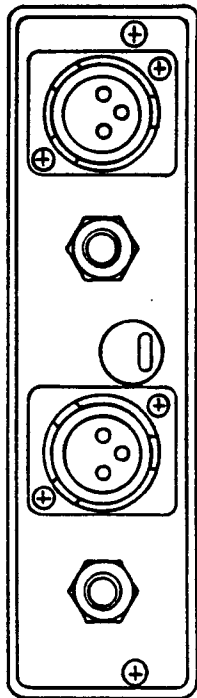
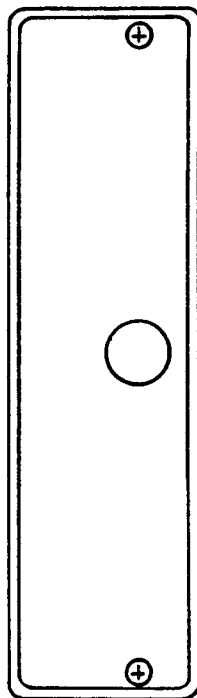
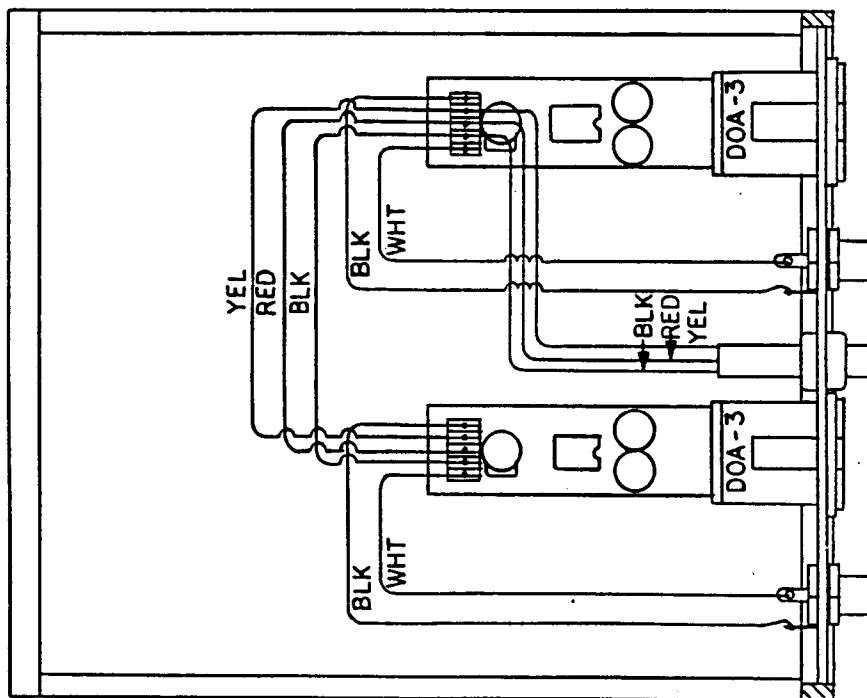

NOTES:
I. POWER CORD MAY PASS THROUGH EITHER
END PLATE.

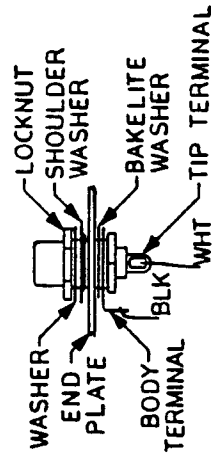

RCA JACK DETAIL

Benchmark Media Systems

IFA-3

SCALE	CHECKED BY	DRAWN BY	PENFIELD
DATE	7/28/88	W. J. Penfield	
SHEET	B	WIRING DIAGRAM	DRAWING NO. 350017

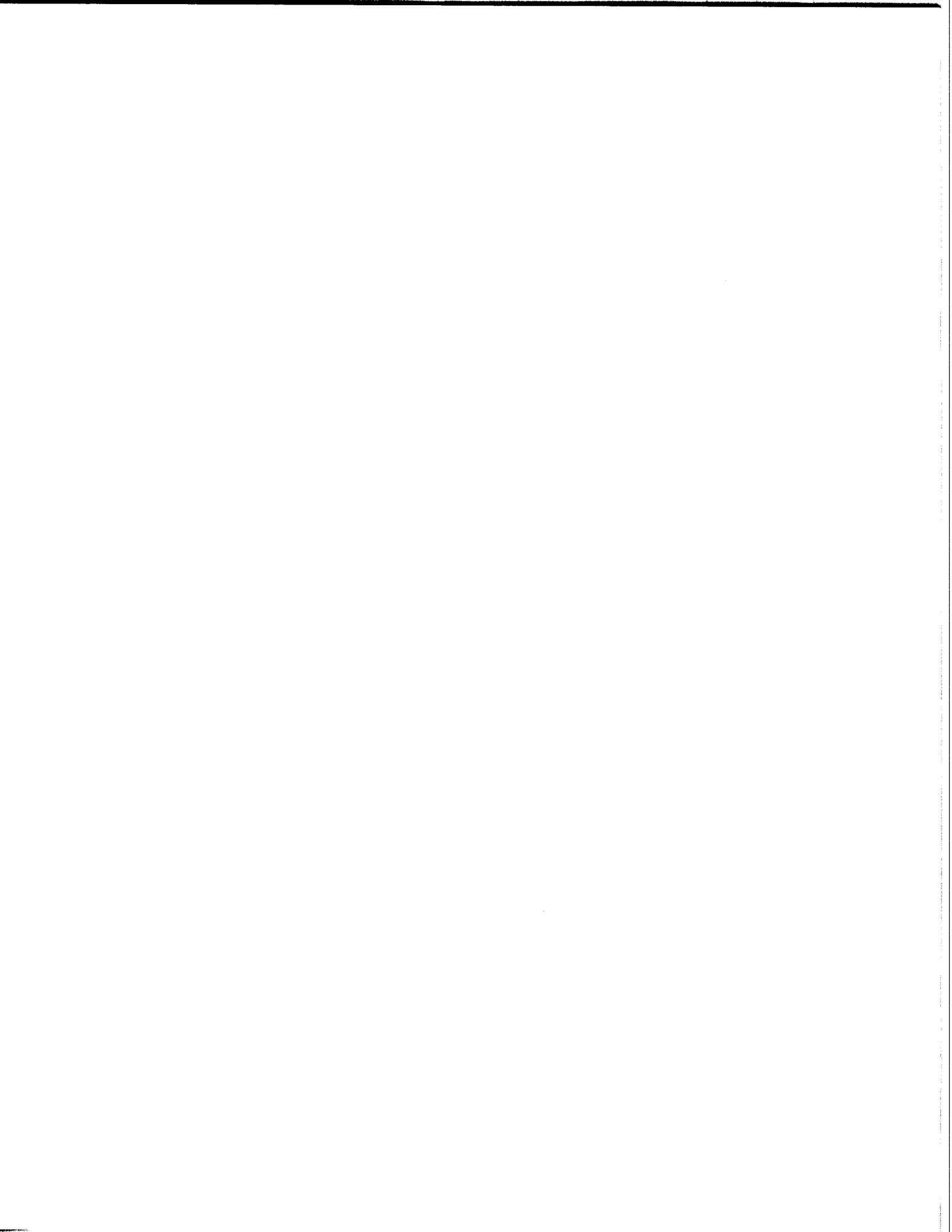

BENCHMARK MEDIA SYSTEMS, INC.

DOA-1,2 and 3 Instruction Manual

Table of Contents

1.0 Introduction	1
2.0 General Features.....	1
3.0 Unpacking and Installation.....	1
3.1 Physical Installation.....	1
3.2 Electrical Installation	2
3.2.1 Power Connections.....	3
3.2.2 Input and Output Connections.....	3
3.2.3 Output Impedance.....	3
3.2.4 Balanced or Single Ended Outputs.....	4
3.2.5 Terminations and Output Amplitude.....	4
3.2.6 Gain Control and D.C. Offset.....	5
3.2.7 Remote Installation of the Gain Control.....	5
4.0 Troubleshooting and Repair.....	6
4.1 Soldering Technique	6
4.2 Circuit Board Re-Soldering	7
5.0 Component Assembly	9
6.0 Electrical Schematic	10

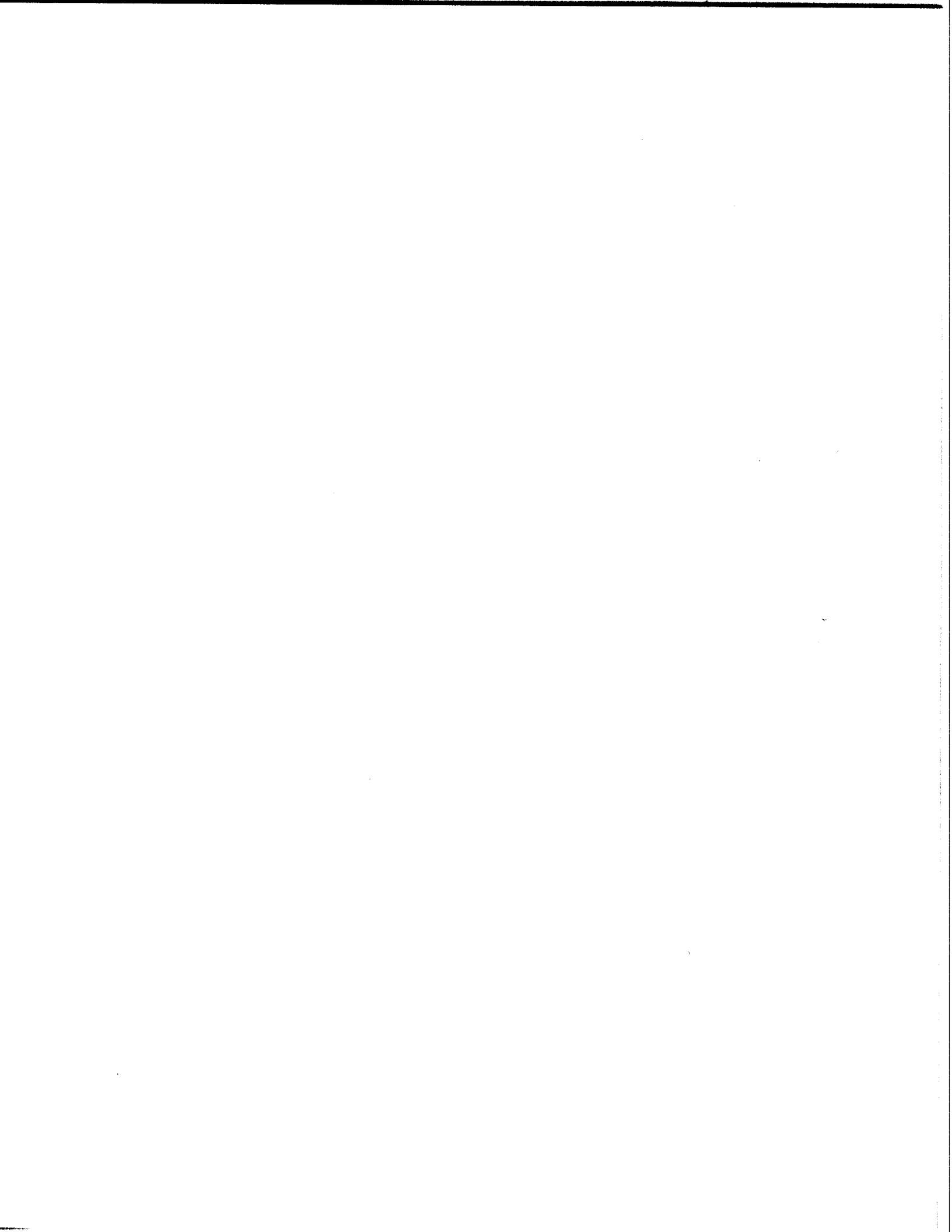

1.0 Introduction

The DOA-1, 2 & 3 Differential Output Amplifiers are universal output devices designed to provide both a balanced output and the gain necessary to interface consumer and semi-professional audio equipment to the professional environment.

2.0 General Features

The DOA-1, 2 & 3 balanced output devices have variable gain from full Off to +26 dB, an output impedance of 60 ohms, an input impedance that varies with the amplification factor that is used (100 k Ω max, 10 k Ω min) and in the case of the DOA-1, an adjustable DC offset voltage trim that is set by the user. Both the DOA-1 and 3 are for use with bipolar power supplies, while the DOA-2 is for use with a single "plus" supply. The DOA-1 is a DC coupled device. The DOA-3 is similar to the DOA-1 but with an AC coupled output stage. It has output coupling capacitors and is minus the DC offset circuitry. The DOA-3 satisfies the need for a bipolar powered device that allows continuously adjustable output level without the problem of continuously changing DC offset voltage.

All circuitry is on small printed circuit boards that may be mounted on either a 1/4" TRS jack or an XLR type jack, both Switchcraft and Neutrik types, or it is also available as card only. The operational amplifier used is a NE5532 for outstanding aural performance.

3.0 Unpacking and Installation

As with any delicate electronic equipment, care must be exercised in the handling of this board. Carefully unpack the DOA-1, 2 or 3 and place it on the work table for installation in the intended equipment. Care has been taken during packing to assure the withstanding of normal shipping conditions. Examine the equipment carefully as it is unpacked. If the shipping carton appears to have been damaged during shipment check the equipment and notify the carrier and Benchmark immediately if there are signs of damage.

3.1 Physical Installation

The appropriate holes must be drilled or punched in the equipment chassis intended to receive the DOA. For 1/4" jack installation a 3/8" hole should be drilled. From a practical standpoint it is well to start with a small drill size, such as a 1/8", as a pilot hole. A 1/4" intermediate hole also a genuine help before drilling the final 3/8" size. This will enable more precise location of the jack. If you do not have a de-burring tool, a larger drill bit will work for that operation.

!!! Warning !!!

Be careful not to over tighten the nut on the plastic threads of the 1/4" jack. It is very possible to strip the threads on this connector.

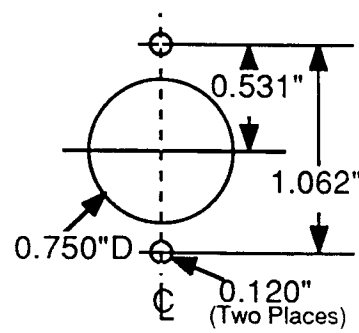

Fig 3.1 Switchcraft D3M Drill Template

Figure 3.1 shows the drill pattern for the Switchcraft D3M connector. Drill the appropriate holes and mount the DOA-1, 2 or 3.

3.2 Electrical Installation

The DOA-1 must be powered from bipolar supplies. The power voltage range is from ± 9 to ± 24 volts. A group of three wires at the rear of the DOA-1 are used to bring power into the device. The red wire must connect to the positive supply, the blue wire to the negative supply, and the black wire to the power supply common point. See figure 3.2 for the correct pin assignments. The output connections shown are for Tip Ring Sleeve type 1/4" jack or board only, but not for the XLR type connector. For the XLR connector the inverting output and the signal ground pins are reversed.

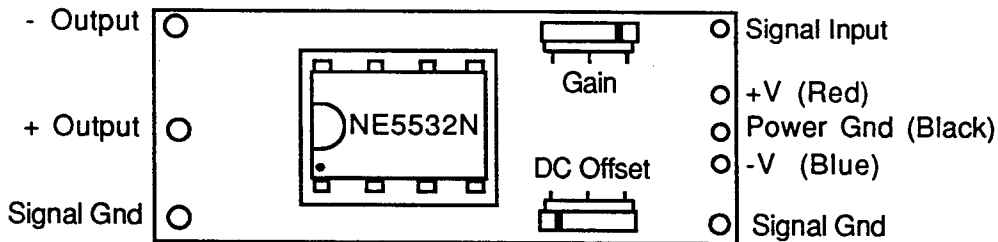

Fig 3.2 DOA-1 Connections and Controls

The DOA-3, has the same powering requirements and signal inputs as the DOA-1. See figure 3.3. Once again the inverting output and the signal ground positions are for the 1/4" connector or board only, not for the XLR type connector.

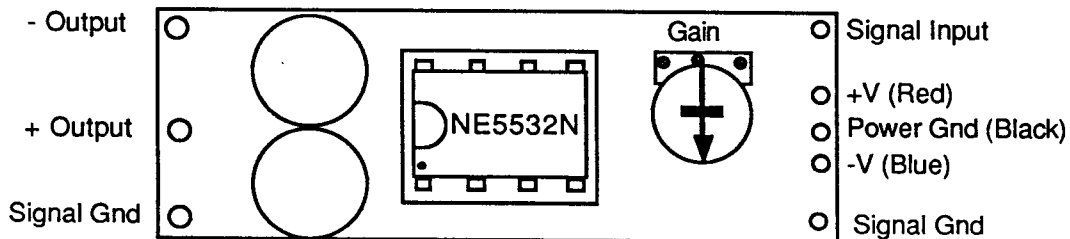

Fig 3.3 DOA-3 Connections and Controls

The DOA-2 must be powered from a single positive supply. The power voltage range is from +18 to +44 volts. Two wires at the rear of the DOA-2 are used to bring power into the device. The red wire must be connected to the supply's positive terminal and the black wire to the supply's negative terminal. See figure 3.4 for the correct pin assignments.

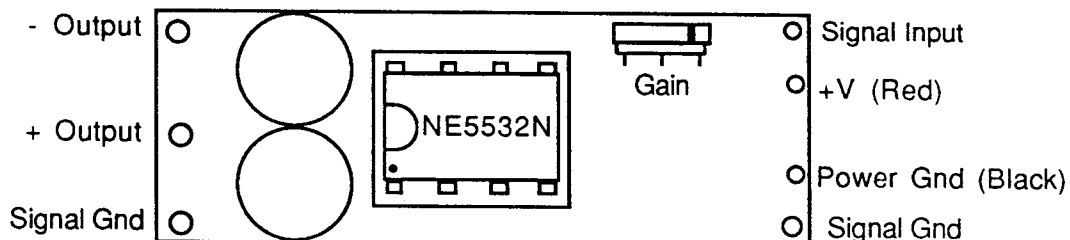

Fig 3.4 DOA-2 Connections and Controls

Input connections are made at the right end of the board. Input wires should be soldered to the two extreme outside holes, the input signal to the top hole and the ground to the bottom hole.

The output connections, as identified on the pictorial, are correct for the board only and the 1/4" TRS jack, but not for the XLR type connector.

3.2.1 Power Connections

Use the highest power supply voltage possible within the constraints of the op-amp limits. Often within a piece of equipment you will find both unregulated voltages of ± 15 to ± 18 volts as well as ± 9 to ± 12 volts regulated (+30 and +24 respectively for the DOA-2). It is sometimes possible to use the raw DC voltages, provided the ripple content is very low, to power the DOA-1, 2 or 3. But since the NE5532 does not have good power supply rejection, caution must be exercised when doing this. Using the highest voltage available will give the best headroom, but high ripple content may degrade the signal to noise ratio, particularly in the annoying 120 Hz range. So use this only if you can measure the results of your work.

The maximum power supply voltage allowed by the manufacturer of the operational amplifier is ± 22 volts (+44 for the DOA-2). ± 18 (+36) volts however will allow a cooler device. The use of ± 22 (+44) volt supply rails results in an increase in quiescent current drawn by the op-amps. The resultant heating of the chip increases the input bias currents. As the chip gets hot, the output current limit point is reduced, and if the device actually should have a 600 load (not recommended) the maximum output capability is actually LOWER than if the power supply voltage were at ± 18 volts. On the other hand some audio equipment uses ± 24 (+48) volt power supplies, and it is desirable to maintain the same output voltage capability with the addition of the differential output amplifiers. It is our experience that the NE5532 will work without loss of reliability with these limits even though they are beyond the specification given by the manufacturer, provided the output feeds a bridging input. The chip will, however, run very warm to the touch.

3.2.2 Input and Output Connections

If the DOA-1, 2 or 3 was purchased with a connector attached, then of course, no output connections need be made to the board. If you purchased a board only, then the intended output wires must be soldered to the PC board according to figures 3.2. and 3.3. The unbalanced input connection must also be made as discussed above. Use the Figure 3.2, 3.3 and 3.4 to identify the correct hole locations.

!!! Warning !!!

The DOA 1, 2 & 3 are constructed on single sided printed circuit boards that may be easily damaged by excessive heat while soldering. It is very easy to "lift" a run from the board. Therefore extreme caution must be exercised during the soldering process. We strongly recommend the use of a temperature controlled soldering station, set for 600°F. See the section on soldering in the Troubleshooting and Repair section 4.0

The DOA-1 is a DC coupled device, therefore you must be sure that no DC voltage is present at the output of the original equipment. If this is not done the DOA-1 will amplify this DC voltage. If DC is present, a 10 μ F aluminum electrolytic capacitor should be installed, observing voltage polarities, between the signal source and the input of the DOA-1.

The DOA-3 should be treated the same as the DOA-1. While there is no input coupling capacitor, any amplified DC will reduce the headroom of the amplifier. Also, DC on the input presents the possibility of a polarity inversion on the output coupling capacitors.

The DOA-2 has no need for further isolation, as it already is an AC coupled device.

3.2.3 Output Impedance

The output impedance of the DOAs is 60 ohms balanced, 30 ohms unbalanced. This is achieved with 1% metal film build-out resistors. A 60 ohm output has been found to be the optimum drive impedance for today's foil shielded cables. This allows the longest possible cable runs to

be made without excessive high frequency roll-off and without significant high frequency response peaking.

If the shielded pair being used has 32 pf/foot capacitance between conductors (not shield) then for a system high frequency cutoff of say 30 kHz, the maximum length of cable that may be used is 2947 feet, or approximately 900 meters. This is ten times the length possible, under the same constraints, if the output impedance were 600 ohms, with a bridging input.

The total C is determined by:

$$C = \frac{1}{2 \pi f_c R} \quad [3.1]$$

where in this case C is the maximum allowable cable capacitance, R is the output impedance, in this case 60 ohms, and f_c is the lowest system high frequency cutoff that we can tolerate. Obviously using low capacitance cable will further improve our limits.

The total number of feet of whatever cable chosen is found by:

$$\text{Feet max} = \frac{C}{\text{Cable pf/ft}} \quad [3.2]$$

Using the DOA-1, 2 or 3, the maximum cable length that may be driven, from the standpoint of available current (40 mA peak) to feed the cable capacitance, is approximately 300' at 32 pF/foot. Belden 9700 series, a foil shielded data transmission cable line, at 12 pF/foot, and Mogami 2574 at 6 pF/foot allow proportionally longer lines to be driven. See "A Clean Audio Installation Guide" by Allen H. Burdick, A Benchmark Media Systems application note.

3.2.4 Balanced or Single Ended Outputs

The DOA-1, 2 or 3 can be used either as balanced or a single ended output driver. When used as a balanced output device, both of the outputs, inverting and non-inverting will, of course, be utilized. When used as a single ended output for its gain capability only, be sure only one of the two outputs is utilized, either the inverting or the noninverting. Under no circumstances should an output be tied to ground as would be done with a transformer type output. Unlike transformer type outputs, the active balanced output is already ground referenced.

!!! Warning !!!

Tying one of the outputs to ground will cause a large amount of distortion to occur as well as overheating of the operational amplifier.

3.2.5 Terminations and Output Amplitude

As already indicated, the impedance matched audio interconnect system developed in the days of tube amplifiers is now passé for anything but extremely long cable runs. With modern operational amplifier technology it is no longer necessary nor even desirable to terminate audio lines with a "matched" low impedance, unless you are the Phone Co. with miles of cable, the length of which approaches 1/4 wavelength at the highest frequency of interest, i.e. 2.33 miles at 20 kHz.

Today the voltage sourced interconnect system is becoming universally used. The voltage sourced system features a low source impedance of approximately 50 to 60 ohms, and a high input impedance of 10 K ohms or higher. The advantages are:

1. Less power drawn from the source equipment, therefore less heat generated.
2. Lower distortion generated by the output stage doing the driving.

3. 14 dB lower noise pickup by the interconnect lines due to the lower source impedance.

The DOA-1, 2 & 3 were designed with this in mind and while they will drive a 600 ohm load, they do so with reduced headroom (lower clip amplitude) due to the internal current limiting of the op-amp used. Additionally there is a not insignificant increase in distortion generated by the operational amplifier. Therefore, for the best headroom and system performance, DON'T put a 600 ohm resistor at the receiving end of the cable being driven by either the DOA-1, 2 or 3. The only exception to this might be in a high RF environment, where the resistor could tame the line in terms of RF power.

PS Voltage & Quies I	Max Out Unterm.	Max out 600 Ω Term.
+44 or ± 22 V @ ± 12.0 mA	+30 dBu	Op-amp overheats
+36 or ± 18 V @ ± 9.50 mA	+28 dBu	+26 dBu
+30 or ± 15 V @ ± 8.60 mA	+26 dBu	+25 dBu
+24 or ± 12 V @ ± 7.75 mA	+24 dBu	+23 dBu
+20 or ± 10 V @ ± 7.50 mA	+22 dBu	+21 dBu
+18 or ± 9 V @ ± 7.50 mA	+21 dBu	+20 dBu

Fig 3.3 DOA Output Limits and Quiescent Current

The maximum output from the DOA operating as an unbalanced output is always 6 dB lower (1/2 the voltage available) than when operating as a balanced output.

3.2.6 Gain Control and D.C. Offset

The gain of the DOA-1, 2 & 3 is adjustable from full Off to +26 dB balanced or +20 dB unbalanced. Because these devices use the potentiometer within the feedback loop of the amplifier, optimum signal to noise ratio is always maintained. This is because only the amplification necessary to perform the task is asked of the op-amps. The output noise at maximum amplification is -85 dBu and at minimum amplification is -105 dBu. 0 dBu is equal to 0.7746 volts RMS. Therefore at the manufacturer's recommended maximum power supply voltage of ± 22 volts and at maximum amplification, the dynamic range of the DOAs is 115 dB (-85 dBu to +30 dBu). Worst case (minimum power voltage of ± 9 volts) the dynamic range is -85 dBu to +21 dBu = 106 dB. Best case performance, at unity gain or less, yields a total dynamic range of 130 dB.

Since the DOA-1 is a DC coupled device it is necessary to adjust the offset voltage once the device has been fully installed and its gain set. We recommend the use of the Fluke 8050A for this operation if possible, since it has a resolution of 10 μ V at maximum sensitivity. If you are going to use the unit as an unbalanced output then adjust the offset voltage while measuring between the chosen output and ground. If the device is used as a balanced output, then the trim should be made while measuring between the two outputs. This adjustment must be made with no audio signal passing through the amplifier.

3.2.7 Remote Installation of the Gain Control

The on board potentiometers of the DOA-2 and DOA-3 may be removed and 100 k Ω linear taper panel potentiometer potentiometers may be substituted. The principal thing to be remembered is that the summing node of the amplifier is one on these leads and needs to be kept as short as possible to avoid hum pickup. Twisting the wires will aid somewhat in hum rejection.

If you already own DOA-1s and not DOA-3s, it may be desirable to do the following modification and add the components that are already on the DOA-3. Output capacitors must be added to isolate the continuously varying offset voltage from the equipment being fed. It is most desirable to use 100 μ F or larger capacitors to preserve the common mode rejection of the input stage that is receiving this signal. Additionally, 100 k Ω resistors should be connected between the output (after the capacitors) and ground to drain leakage currents. See Figure 3.5

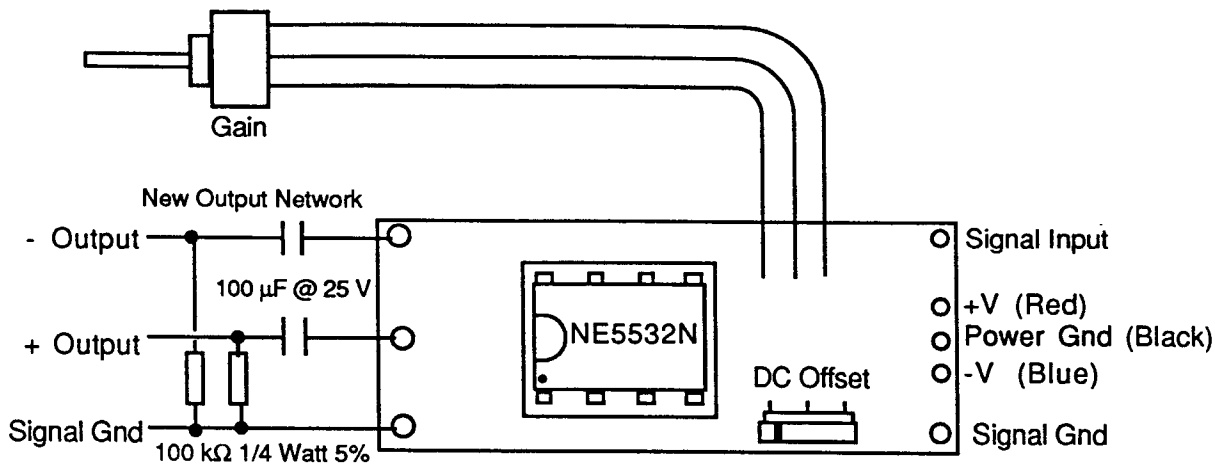

Fig 3.5 Remote Gain – Output Capacitors for DOA-1

4.0 Troubleshooting and Repair

The DOA-1, 2 & 3 are carefully constructed of very high quality components, thoroughly tested before shipment and therefore will probably never need servicing. Should a problem occur with your device, the following will aid in locating the problem.

The first step in troubleshooting, is to check for solder shorts and other mechanical problems that may have occurred during the installation. Many problems may be solved by close visual inspection. We heartily recommend the use of an "OptiVISOR", manufactured by Donegan Optical Co., or equivalent stereo optical magnifier.

If inspection reveals that no solder bridges were created during installation, the DC operating voltages should be checked. First determine that the proper power voltages exist at pins 4 and 8 of the operational amplifier. With the DOA-1 & 3 a positive voltage, referenced to ground, at pin 8 (the full power supply voltage) should be present. Likewise a negative voltage at pin 4 should be present. In the case of the DOA-2, pin 4 is ground and pin 8 should have the full power voltage present. The output pins of the amplifier should be checked next, that is, pins 1 and 7 on both devices. The DOA-1 should have less than 5 mV at either output after trimming, and in reality 100 µV or less, is not unreasonable. Again, these measurements should be made with no audio signal present. The DOA-2, on the other hand, should have a voltage that is nearly one half that of the power voltage present at both outputs. The DOA-3 will have a DC offset voltage that is dependant upon the gain of the amplifier, but in any case should be less than 0.2 volts either positive or negative. If the output voltages are not correct, under no signal conditions, the replacement of the operational amplifier will in most cases fix the device.

On extremely rare occasions a faulty passive component may exist. If you are unable to locate the problem, a reasonable amount of troubleshooting assistance is available, via telephone, from the customer service department at Benchmark Media Systems.

4.1 Soldering Technique

Printed circuit boards are very easy to damage by excessive heat. Unless you have developed the specialized skills necessary to remove and replace components, we suggest that you leave the task to someone skilled in these techniques.

When servicing printed circuit boards we strongly recommend the use of a vacuum de-soldering station, such as the Pace MBT-100. The proper technique with these stations is to apply the tip to the area to be de-soldered and wait for the solder to thoroughly melt. When the solder has become liquid, apply the vacuum while moving the hollow tip with the component lead in a circular motion. By rotating the lead, with the tip against the board, but without applying pressure to the pad, you are able to most thoroughly remove the solder. In turn the component will often drop out of the circuit board when you are finished.

4.2 Circuit Board Re-Soldering

NASA has developed an effective technique that ensures highly reliable solder joints. It involves first heating the component lead, since it usually has the higher mass, by applying a small amount of solder to the tip of the soldering iron at almost the same time as you apply the iron to the component lead. This will allow some flux to make it to the component lead. The iron should be approximately 1/8" above the board. When the lead has come up to temperature so that it melts the solder when placed against it and has good wetting, slide the soldering iron down the lead and heat the printed circuit board pad while applying a controlled amount of solder to the joint. All of this should take no more than a couple of seconds. If the component that is to be installed has leads that are oxidized, it will be necessary to clean them. This may be done with either a Scotch Bright® abrasive pad or fine bristle fiberglass brush, among other methods.

This completes the DOA-1, 2 & 3 instruction manual.

Ed. 13 March 1988

BENCHMARK MEDIA SYSTEMS INC.

5925 Court Street Road
Syracuse, NY 13206
Phone (315) 437-6300, FAX 437-8119

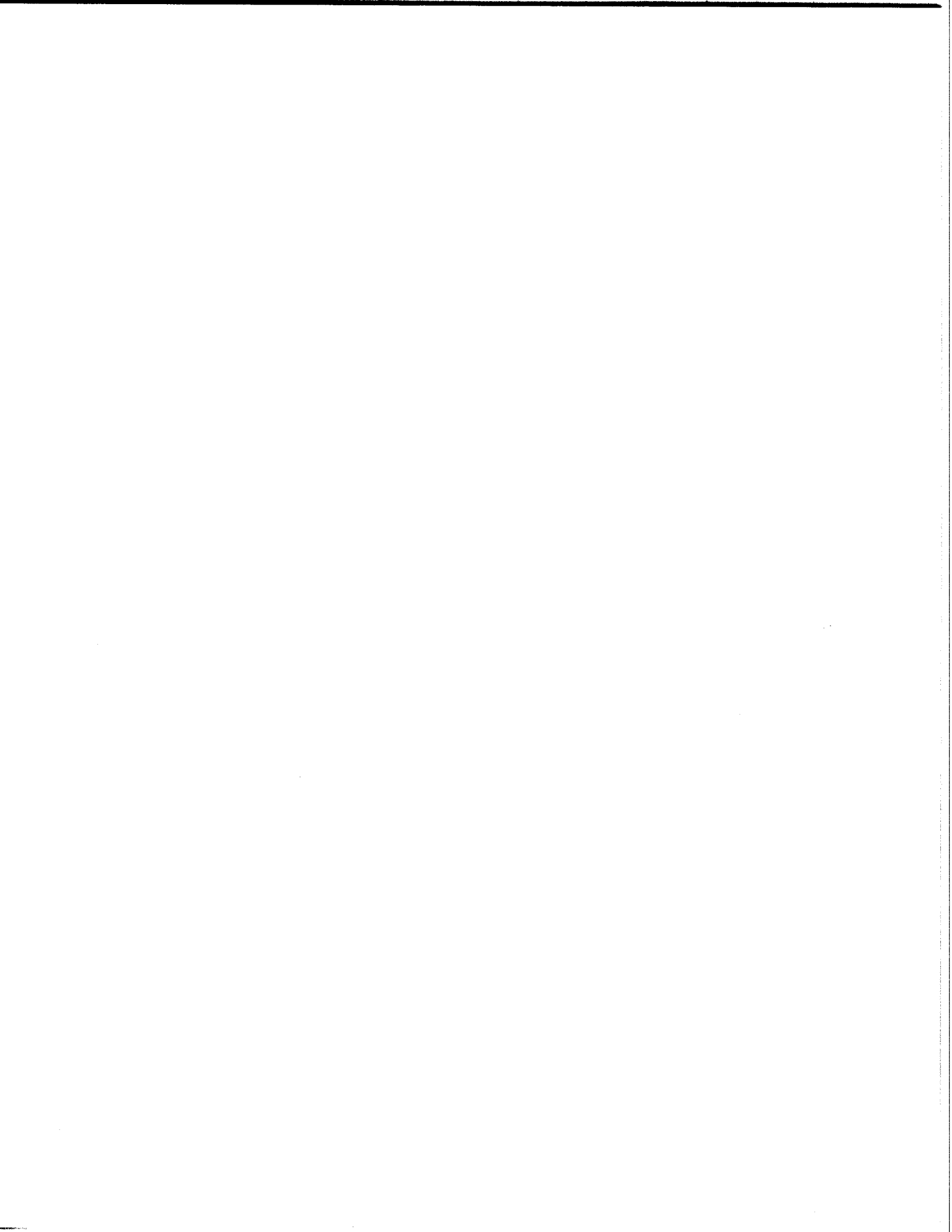

REVISIONS

A SEE DCN NO. 49

12/20/88

J.R.P.

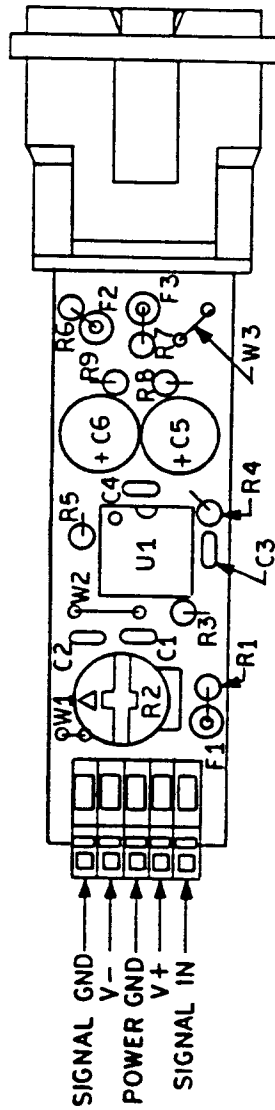

Benchmark Media Systems

DOA-3

SCALE

DATE 2/11/88

SIZE B

CHECKED BY

A.H. Newick

DRAWN BY J.R.P.

COMP ASS'Y

DRAWING NO. 250033

REVISIONS

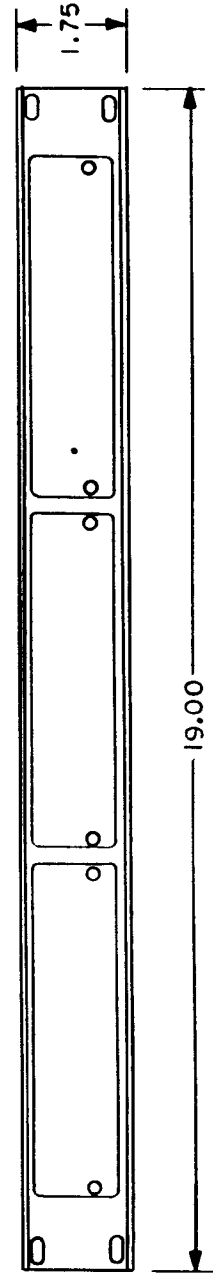
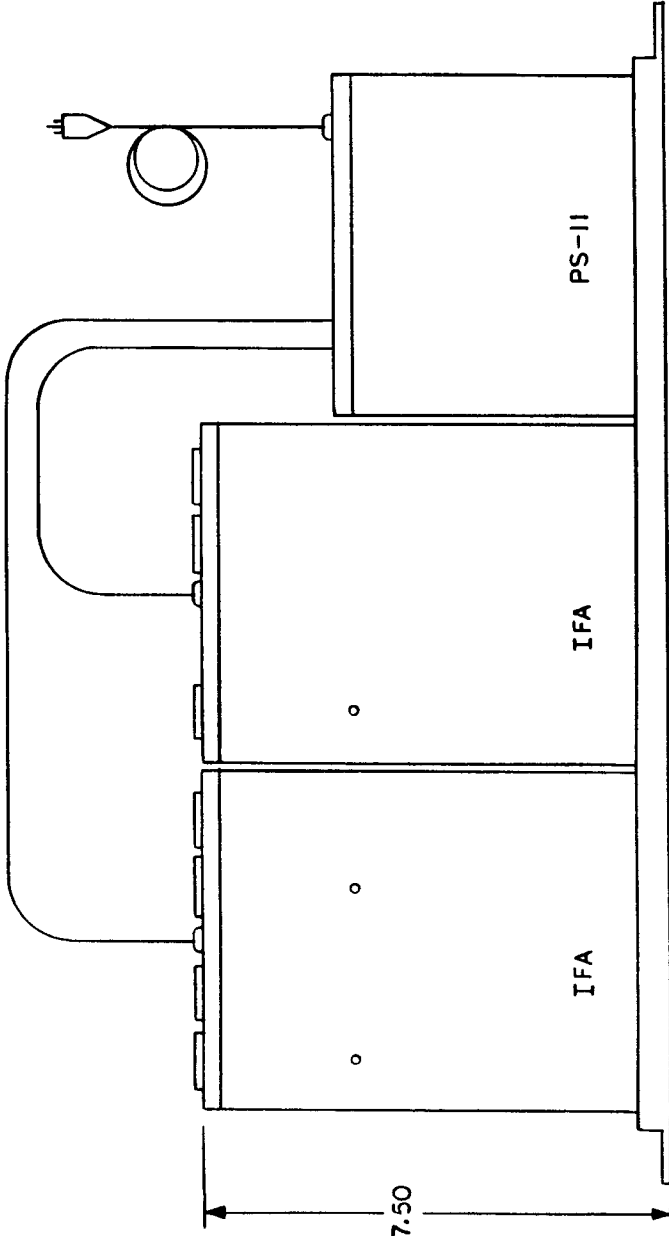

Benchmark Media Systems

RM-1/IFA RACK MOUNT UNIT

SCALE: DRAWN BY: J. PENFIELD

DATE: 5/27/88 CHECKED BY: *W. S. Campbell*

SIZE: B COMP. ASS'Y. DRAWING NO. 2500043

