

HYGIEIA ALURACK
SYSTEM

ACART



TEGASUS
MEDICAL CONCEPTS INC.

A COMPLETELY SEALED AND CLEANABLE ALUMINUM RACKING SYSTEM
BEST FIT FOR YOUR OPERATING ROOM AND CENTRAL STERILIZATION UNIT



ABOUT US

Acart Equipment Ltd in association with Pegasus Medical, the partner of leading healthcare organizations and hospitals in 5 continents.

Our clients recommend our products and solutions since we greatly **simplify healthcare materials** management with flexible and scalable solutions.

We provide **significant cost savings** and stand behind our methodology with **unmatched expertise and support.**

AMONG OUR CUSTOMERS:

PeaceHealth



4 Hospitals in Kanban, ranging from 100-500 racks

US Naval Ships



USNS Mercy & Comfort, approximately 900 racks

US Naval Hospitals



10 Facilities in Kanban, 2650 total racks

Veterans Administration



Kanban and High-Density Storage, over 30 facilities with 7,000+ racks

Penn Presbyterian Med Ctr



250 racks. Kanban & Color Coding

NYC Health+Hospitals



4 Hospitals, Kanban, 2200+ racks.

UNIQUE FEATURES

THE HYGIEIA RACKING SYSTEM WAS DESIGNED TO PROVIDE THE OPTIMUM SHELVING SOLUTION FOR AREAS THAT REQUIRE THE HIGHEST CLEANING STANDARDS

It is best suited for your operating room and central sterilization environment. Hygieia can also be used in any other storage location throughout the hospital

The Hygieia racking system has unique features that don't exist with any other similar systems in the market

SEALED STRUCTURE

The Hygieia rack system is a completely sealed system, there are no open holes within the structure of the frames and therefore all surfaces are accessible for cleaning

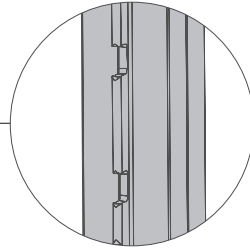

MATERIALS

The entire system is made of powder-coated aluminum; therefore, it can be cleaned with a variety of liquids

Did you know ?!

Hygieia, one of two Greek goddesses of medicine / health - specifically "preventive" medicine, as distinguished from her sister Panacea, the goddess of "treatment" medicine

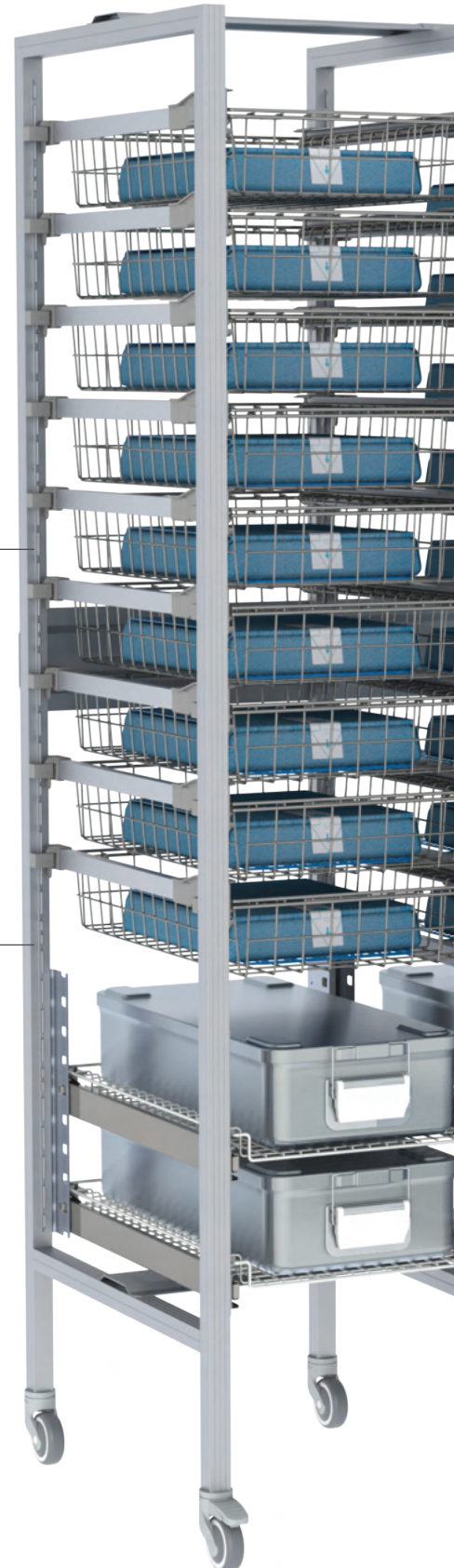

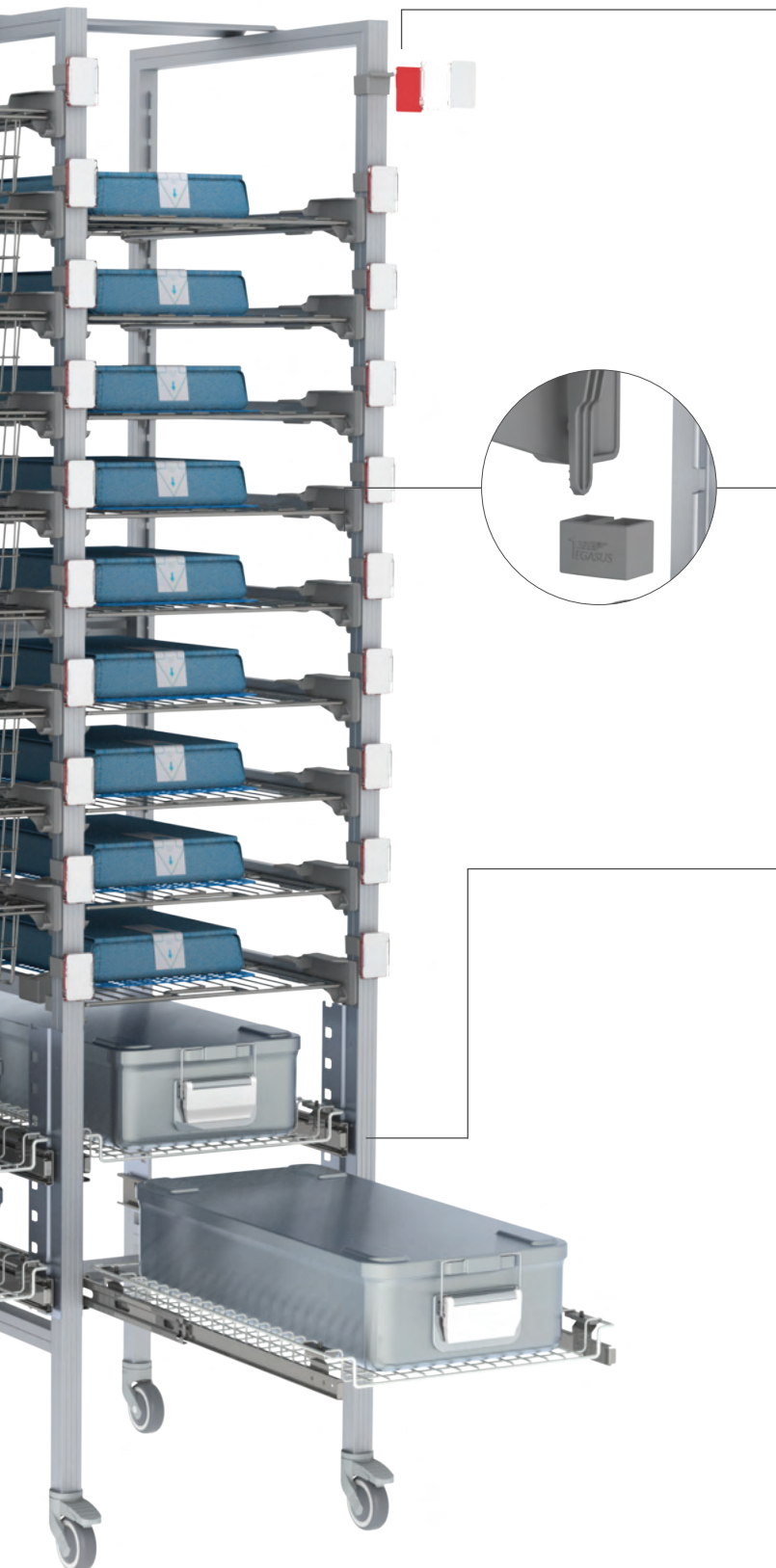

LABELING SYSTEM

While a certain shelf or basket is removed, the related label stays on the frame marking the original position so supplies are also brought back to the same location. This maintains the labeling system and at the same time allows for the washing the trays and shelves

100% MODULARITY

This completely modular system provides, tool free reconfiguration of basket and shelf levels, both for standard rails and heavyweight telescopic slides

TELESCOPIC SLIDES

Hygieia can be equipped with both telescopic slides (for loads over 10KG) or standard plastic rails with horizontal and tilt position

INSTANT ASSEMBLY

Easy assembly and modification as needed

HYGIEIA RACK

THE HYGIEIA RACK IS OFFERED IN TWO ORIENTATIONS, U TYPE AND E TYPE. The two orientations enable us to design maximum storage capacity within a given area. A U type will provide more storage on a given wall while an E type will improve visibility of products and provide a solution for narrow corridors

U Type

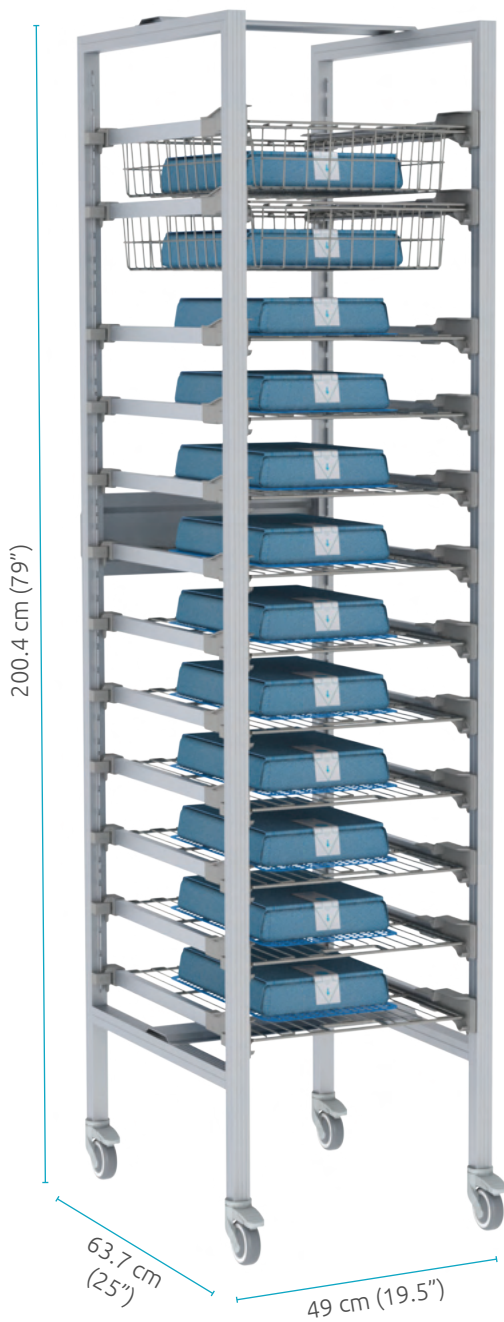

U type basket orientation:
40cm (15.7") wide and
60cm (23.6") deep

E Type

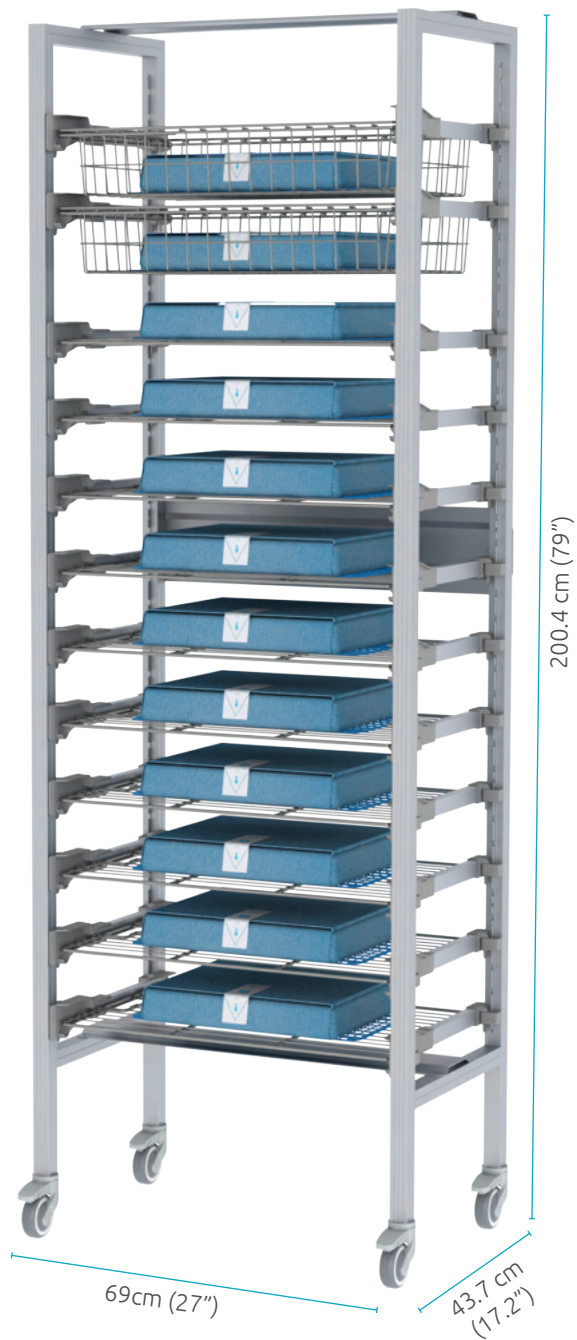

E type basket orientation:
60cm (23.6") wide and
40cm (15.7") deep

Dedicated stainless steel shelving / baskets for sterile pack processing and sterile goods transportation is offered to fit with the Hygieia racks



Containers and sterile packs can be easily located using a color-coding scheme

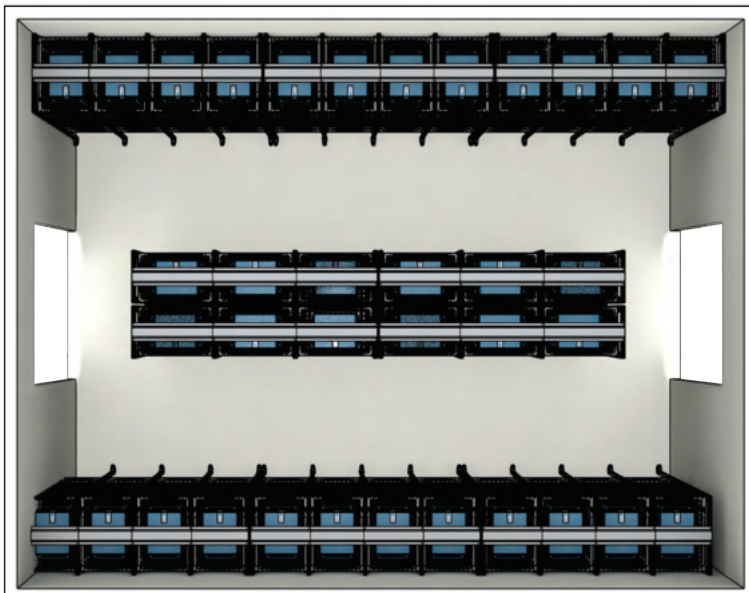

The following CAD illustration demonstrates a typical installation of Hygieia racks in CSSD storage surroundings. The long walls are equipped with U type racks on wheels, in groups of 3 units to enable easy maneuvering for cleaning purposes. The central part of the room is equipped with E type racks, back to back, enabling to maintain a usable corridor space for pushing a cart in between

HYGIEIA CART

THE HYGIEIA OPEN FRAME CART IS A COMPLEMENTARY SOLUTION FOR EFFICIENT/ ERGONOMIC HANDLING AND TRANSPORTATION OF STERILE PACKS, STERILE GOODS AND / OR CONTAINERS, INSIDE THE CSSD OR THE OR DEPARTMENT

CONTAMINATED EQUIPMENT CART

OR suite to CSSD Non sterile area

HYG-CRT160-1-OP



CLEAN / STERILE CART

CSSD to CSSD WAREHOUSE to OR CORE

HYG-CRT160-1-OP



 Contaminated equipment cart

Open carts with yellow high resistance modules will be typically used for transportation of used contaminated tools from the OR/Procedure rooms back to the central sterilization

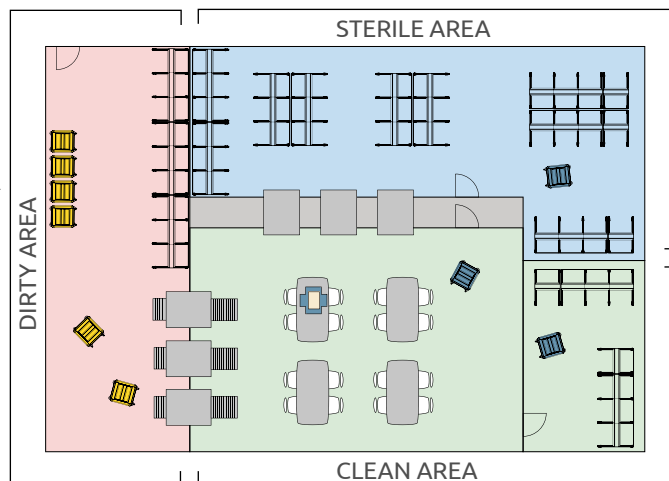

 Clean / Sterile cart

Open storage carts with sterile packs will be used in sterilized environment and "clean" corridors between CSSD and CSSD storage rooms, or operation room clean core.

DIMENSIONS

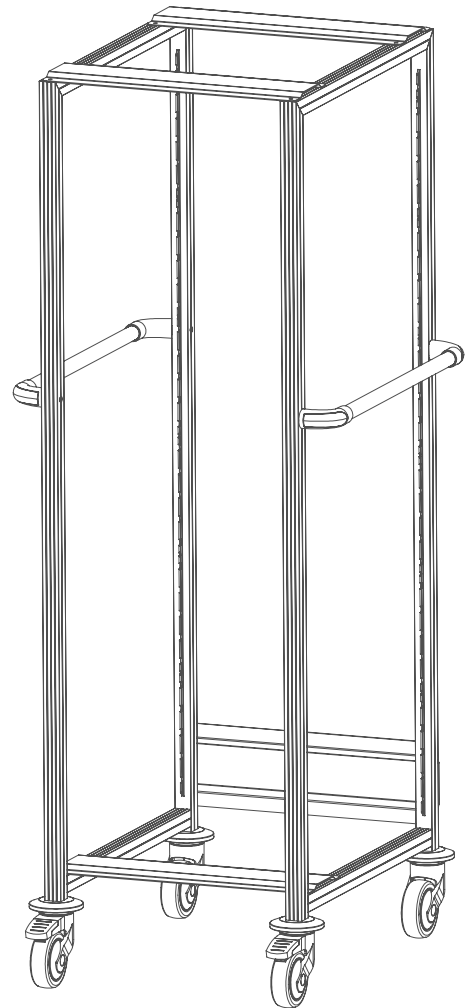
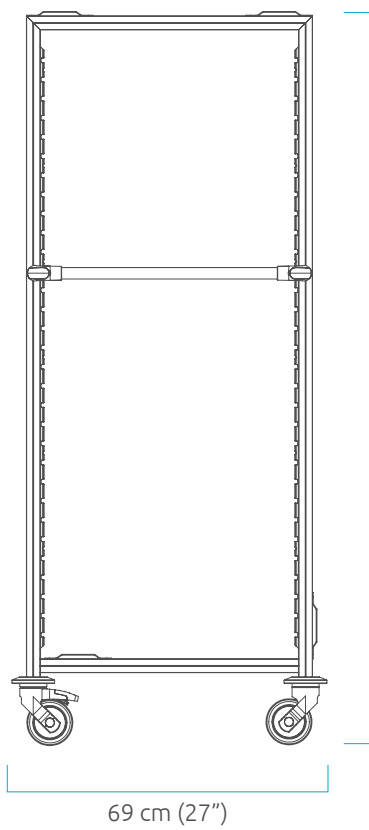
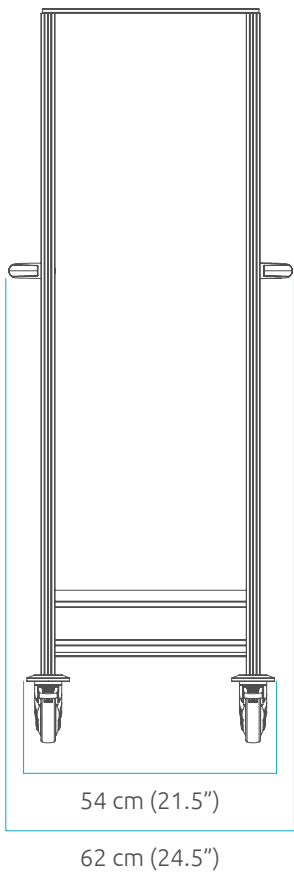
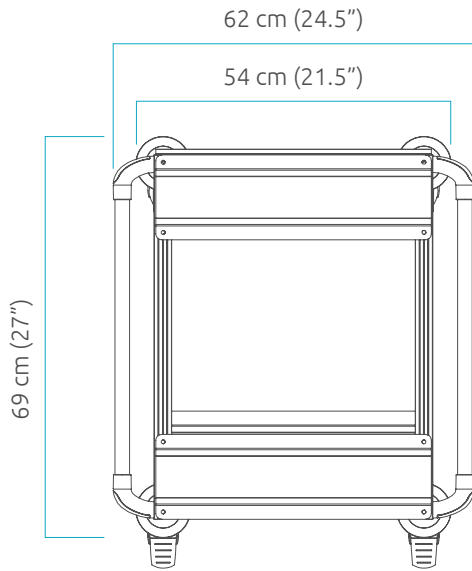

SYSTEM COMPONENTS

RAILS



RAILS HOLDER

Holder for rails on Hygieia
HYG-TRAIL-HLD



RAILS

can be pulled out to the front in a horizontal or tilt position



U Type Rails

Left: **HYG-TRAIL-U-L**
 Right: **HYG-TRAIL-U-R**

E Type Rails

Left: **HYG-TRAIL-E-L**
 Right: **HYG-TRAIL-E-R**

DOUBLE SIDED RAILS

Baskets can be pulled in and out from both sides of the rack/carts



U Type Rails

HYG-TRAIL-U-DS

E Type Rails

HYG-TRAIL-E-DS

"CLICK-IN" WHEELS

Optional for smoother basket sliding

"click-in" wheel
PNWL-SET

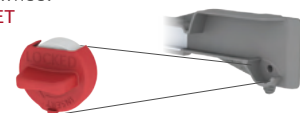

TELESCOPIC RAILS

To be used with container shelves
 100% extension (10pcs per pack)



U Type
BBG-RK-U

E Type
BBG-RK-E

* For safety reasons it is not allowed to load more than 10 kg in baskets placed on telescopic slides at upper levels (above 140cm)

NO Touch™ ACCESSORIES



Stainless steel wire basket
60X40cm (24"X16") | 10cm (4") high
WS-B104060-SS-WH

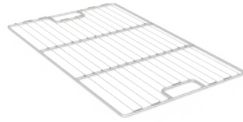

Stainless steel wire shelf
60X40cm (24"X16")
SSS-6040WH



Stainless steel wire basket
60X40cm (24"X16") | 20cm (8") high
WS-B204060-SS

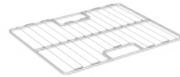

Stainless steel wire shelf
30X40cm (12"X16")
SSS-3040WH

Related accessories

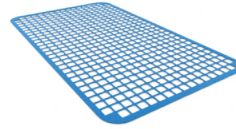

Non-slip silicone mesh mat
42X25cm (16.5"X9.8")
SIMAT-250X420



Stainless steel handle
for wire basket
WS-HANDLE-SS-FBS

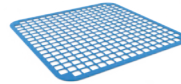

Non-slip silicone mesh mat
25X25.5cm (9.8"X10")
SIMAT-250X255

CS PS ACCESSORIES

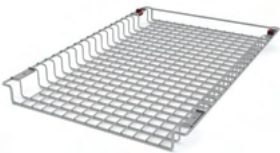

Instrument container shelf – stainless steel
WS-INSTR-SS

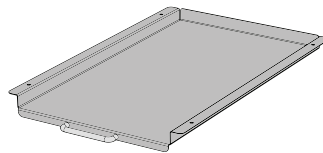

Stainless steel U flat container shelf
SS-U-CNT-SHELF

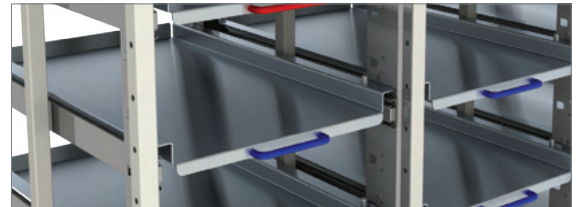

Matte aluminum # **HNDL-112MM-ALU** Red # **HNDL-112MM-RED**
Blue # **HNDL-112MM-BLUE** Yellow # **HNDL-112MM-YLW**
(10 pcs per pack)

ISC640 ACCESSORIES

HIGH RESISTANCE

Used for cleaning application in the central sterilization facilities

ANTIMICROBIAL MODULES

Proven to reduce the level of bacteria on the module surface by up to 99% within 24 hours



10cm TRAY - T103040-HR +
LID - L3040-HR

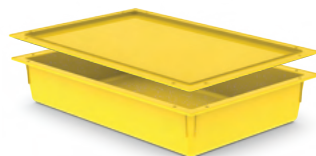

10cm TRAY - T104060-ND-HR
+ LID - L4060-HR



10cm TRAY - T104060-AM
+ LID - L4060-AM



20cm TRAY - T204060-AM
+ LID - L4060-AM

DIMENSIONS

HYGIEIA E Type

HYGIEIA SYSTEM E TYPE

4 Frames per pack: **HYG-SFR-E189**
9 Lateral supports per pack: **HYG-LSU-E**

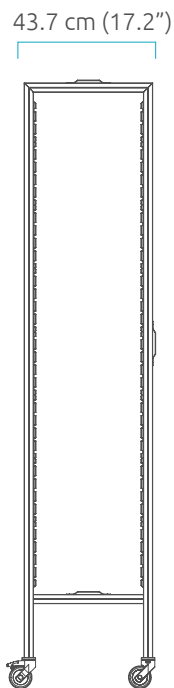
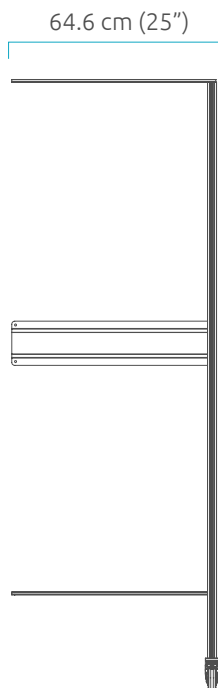
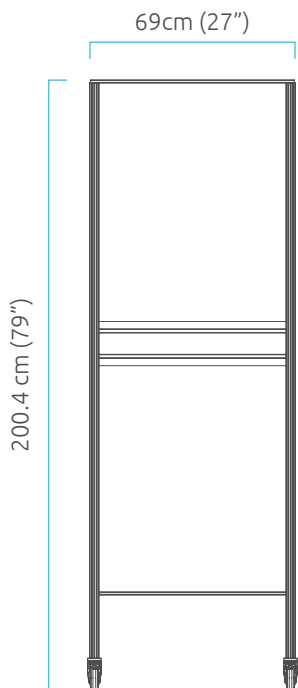

HYGIEIA WITH LEVELING FEET

Leveling feet: **HYG-LVF**

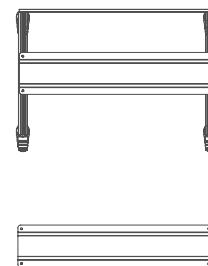

HYGIEIA U Type

HYGIEIA SYSTEM U TYPE

4 Frames per pack: **HYG-SFR-U189**
9 Lateral supports per pack: **HYG-LSU-U**

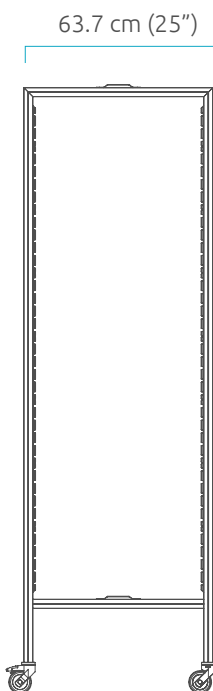
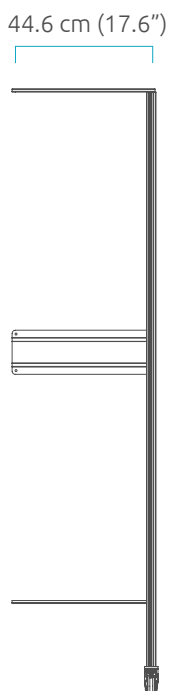
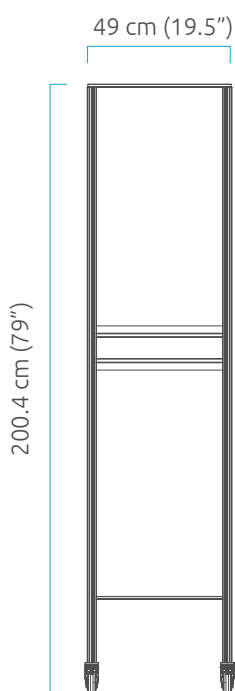

HYGIEIA WITH WHEELS

Wheels: **HYG-CAS3-SET**

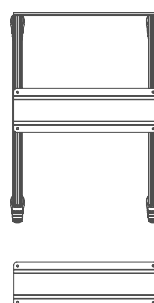

HYGIEIA WITH LEVELING FEET

Leveling feet: **HYG-LVF**

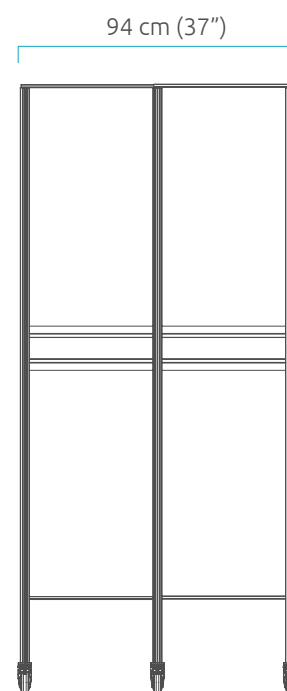

134 cm (53")

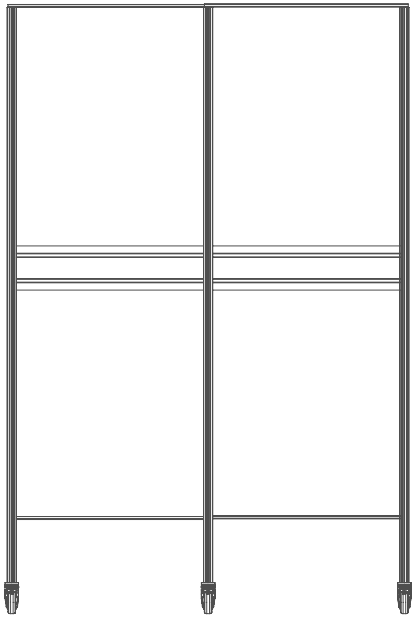

198.5 cm (78")

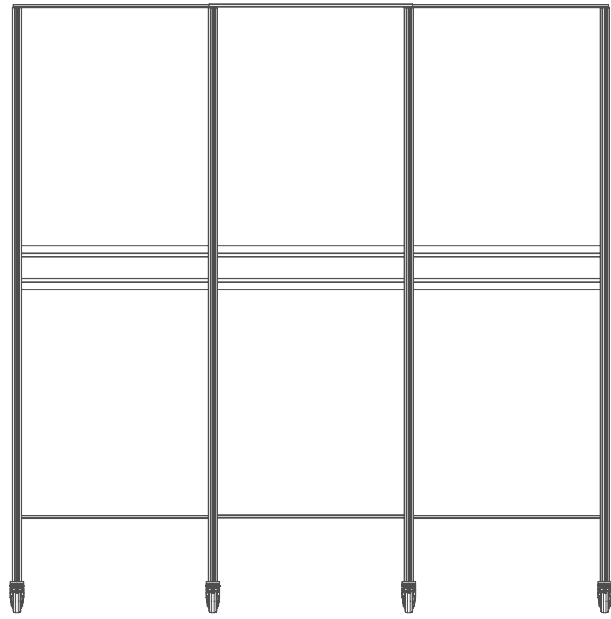

138.2 cm (55.5")

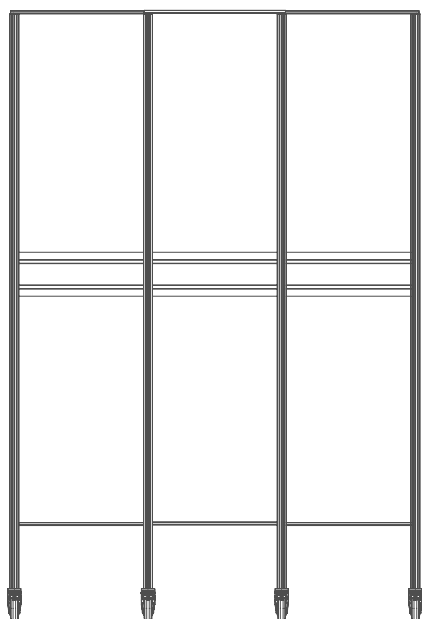

183 cm (72")

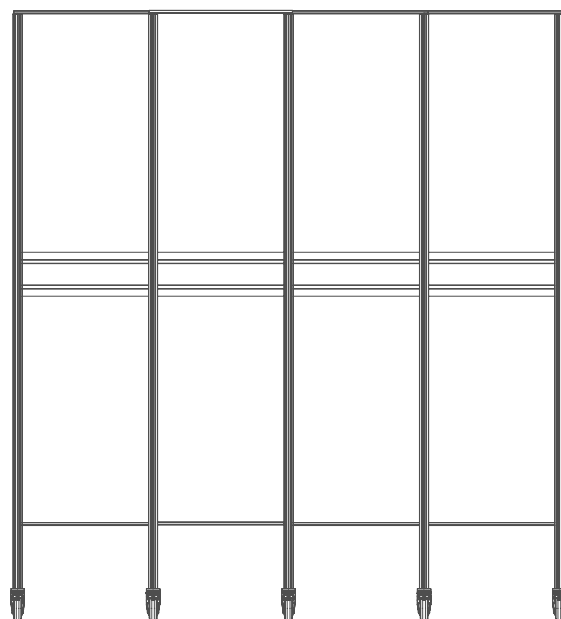

HYGIEIA RACK DIN TYPE

30"/60"
60"/60"

ONLY
USA

THE HYGIEIA RACKS ARE ALSO AVAILABLE AS RACK & OPEN CART THAT FIT WITH DIN TYPE 29.6X60CM (11.6"X24") & 59.6X60CM (23.4"X24")
(Only available in the US or on special orders)

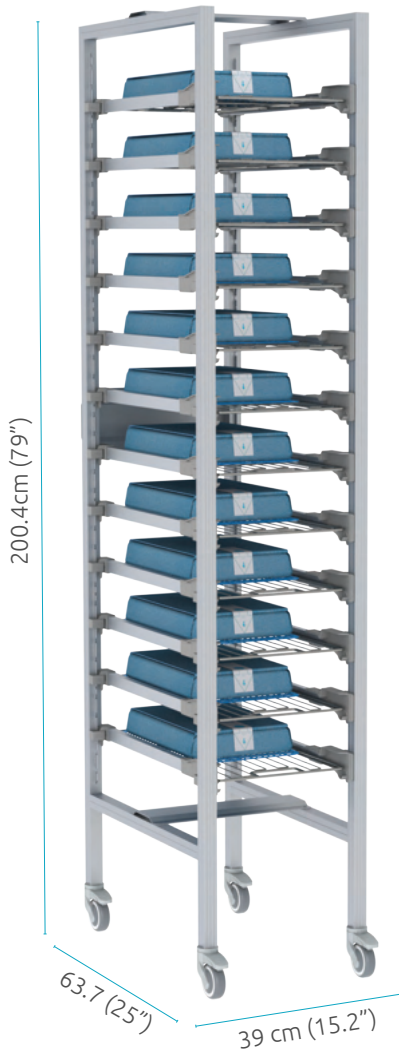

HYGIEIA DIN 3060

HYGIEIA SYSTEM DIN 3060 TYPE

4 Frames per pack: **HYG-SFR-U189**
12 Lateral supports per pack: **HYG-DIN-LSU-296**

HYGIEIA WITH WHEELS

Wheels: **HYG-CAS3-SET**

HYGIEIA WITH LEVELING FEET

Leveling feet: **HYG-LVF**

HYGIEIA DIN 6060

HYGIEIA SYSTEM DIN 6060 TYPE

4 Frames per pack: **HYG-SFR-U189**
12 Lateral supports per pack: **HYG-DIN-LSU-592**

HYGIEIA WITH WHEELS

Wheels: **HYG-CAS3-SET**

HYGIEIA WITH LEVELING FEET

Leveling feet: **HYG-LVF**



Type DIN 3060 Dimensions

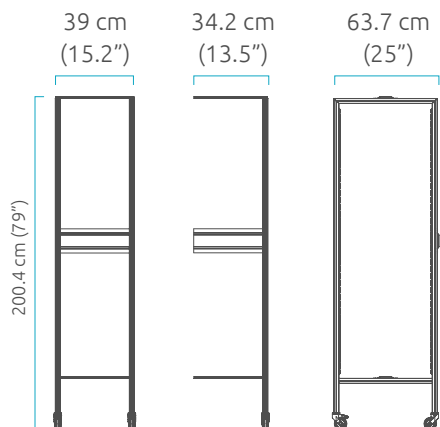

Type DIN 6060 Dimensions

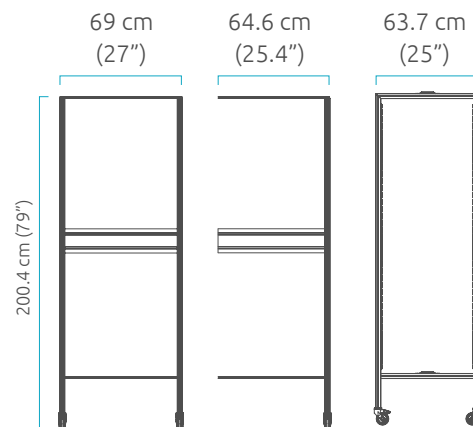

CLEAN / STERILE CART

CSSD to CSSD WAREHOUSE to OR CORE

HYG-DIN-296-1-OP

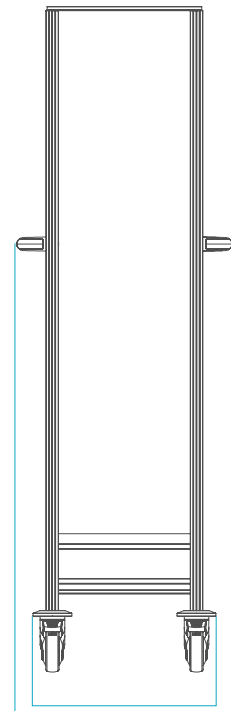
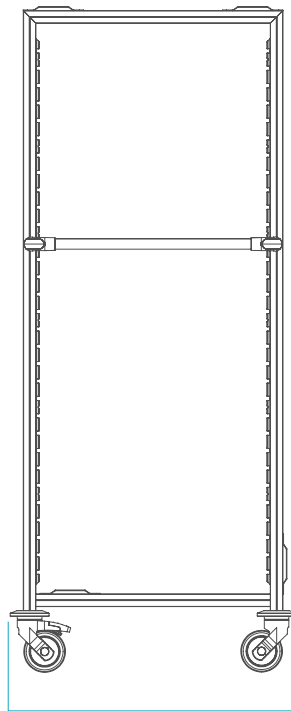
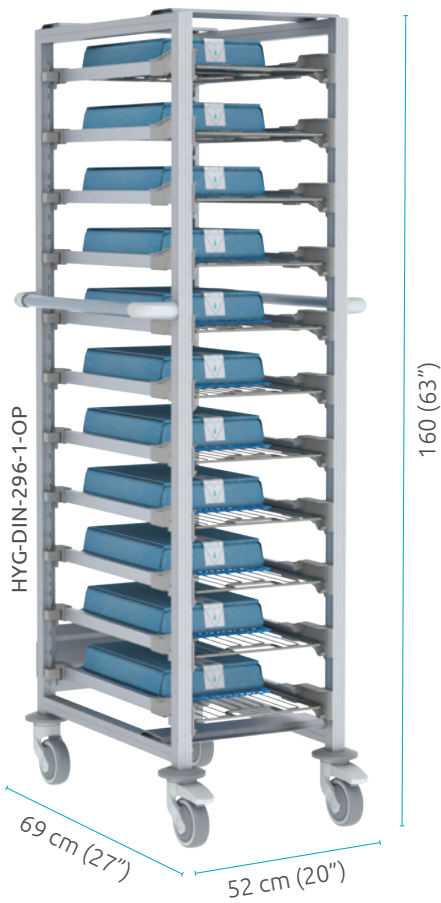

52 cm (20")

NO Touch™ ACCESSORIES

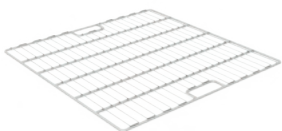

Stainless steel wire shelf
59.6X60cm (23.4"X24")
SSS-6060WH



Stainless steel wire shelf
29.6X60cm (11.6"X24")
SSS-3060WH

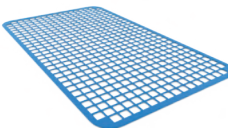

Non-slip silicone mesh mat
42X25cm (16.5"X9.8")
SIMAT-250X420

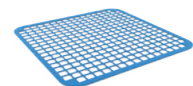

Non-slip silicone mesh mat
25X25.5cm (9.8"X10")
SIMAT-250X255

Related accessories

ACART



CONTACT US FOR MORE DETAILS

TEL: 905-670-6474 | FAX: 905-670-3614 | INFO@ACART.CA | WWW.ACART.CA

1416 BONHILL RD. MISSISSAUGA, ON L5T 1L3