



A CLAMP THAT DOES IT ALL

## KRONOS - THE GLASS CLAMP

- | The first adjustable clamp
- | One clamp for all glass thicknesses – from 8 mm tempered glass up to 12.76 mm laminated safety glass
- | A clamp made from one piece – no assembly of single components
- | Unsurpassed quality
- | Incomparably simple installation
- | Incredible price

# KRONOS

One clamp for all applications

## Inspiring Innovations.

KRONOS by ONLEVEL, the first adjustable clamp ever. While developing this clamp, apart from the price, we always also had efficiency in mind. Creativity and innovation can only work if they go hand in hand with enthusiasm - on all levels: aesthetic design, efficient products and simple installation.

All relevant glass thicknesses instantly adjustable:

Step	Glass Thickness
1	8 mm
2	4/4/2 (8.76 mm)
3	10 mm
4	5/5/2 (10.76 mm)
5	12 mm
6	6/6/2 (12.76 mm)



## Essential Features

- | All relevant glass thicknesses: from 8 mm tempered glass up to 12.76 mm laminated safety glass - instantly adjustable
- | All relevant post connections - flat back and 42 mm, 48 mm post (round)
- | Considerably reduced inventory
- | Considerably reduced technical support
- | Unsurpassed quality - no unexpected widening and loosening of the grip - guaranteed
- | Concealed screws - simply attach the desired cover - clean appearance from both sides
- | Simple installation - no longer do you require fiddly assembly of single components
- | Finish will be 100% identical to post or to the entire project, whatever the colour
- | Made in Germany- timeless precision and quality



## Kronos glass dimensions

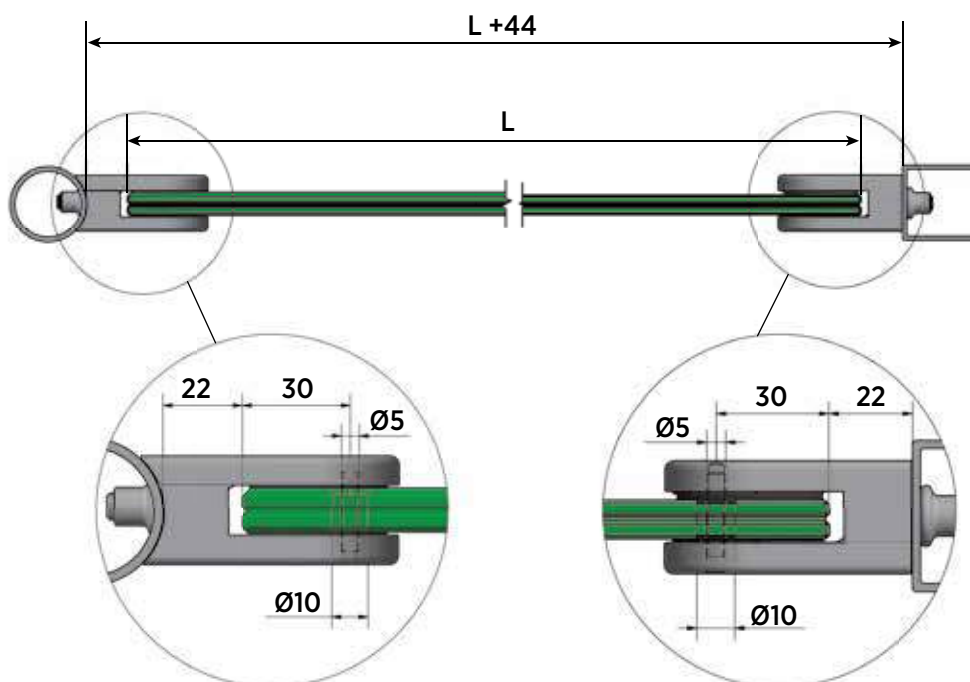



A clamp made from one piece –  
no assembly of single components



Concealed screws – simply  
attach the desired cover

One clamp for all glass thicknesses  
– from 8 mm tempered glass up to  
12.76 mm laminated safety glass



## Kronos, V4A



| Length: 65 mm  
| Height: 45 mm  
| Sales unit: 4 pieces

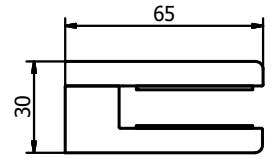

Connection	flat	Ø 42.4 mm	Ø 48.3 mm
	Art. no.	Art. no.	Art. no.
	12.5500.000.31	12.5500.420.31	12.5500.480.31

## Kronos, galvanised steel



| Length: 65 mm  
| Height: 45 mm  
| Sales unit: 4 pieces

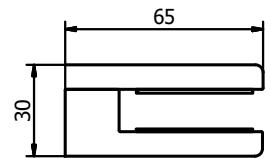

Connection	flat	Ø 42.4 mm	Ø 48.3 mm
	Art. no.	Art. no.	Art. no.
	12.5500.000.81	12.5500.420.81	12.5500.480.81

## Kronos, RAL



| Length: 65 mm  
| Height: 45 mm  
| Sales unit: 4 pieces

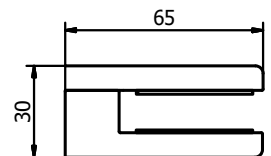

Connection	flat	Ø 42.4 mm	Ø 48.3 mm
RAL	Art. no.	Art. no.	Art. no.
glossy	12.5500.000.83	12.5500.420.83	12.5500.480.83
structured matt	12.5500.000.86	12.5500.420.86	12.5500.480.86
matt	12.5500.000.88	12.5500.420.88	12.5500.480.88

## Kronos Cover Cap, Stainless Steel V4A



| Length: 65 mm  
| Height: 45 mm  
| Sales unit: 4 pieces

Connection	flat	Ø 42.4 mm	Ø 48.3 mm
	Art. no.	Art. no.	Art. no.
	12.5502.000.31	12.5502.420.31	12.5502.480.31

## Kronos Cover Cap, zinc-plated steel



| Length: 65 mm  
| Height: 45 mm  
| Sales unit: 4 pieces

Connection	flat	Ø 42.4 mm	Ø 48.3 mm
	Art. no.	Art. no.	Art. no.
	12.5502.000.81	12.5502.420.81	12.5502.480.81

## Kronos cover cap RAL



| Length: 65 mm  
| Height: 45 mm  
| Sales unit: 4 pieces

Connection	flat	Ø 42.4 mm	Ø 48.3 mm
RAL	Art. no.	Art. no.	Art. no.
glossy	12.5502.000.83	12.5502.420.83	12.5502.480.83
structured matt	12.5502.000.86	12.5502.420.86	12.5502.480.86
matt	12.5502.000.88	12.5502.420.88	12.5502.480.88

## Kronos cover cap PVD



| Length: 65 mm  
| Height: 45 mm  
| Sales unit: 4 pieces

Connection	flat	Ø 42.4 mm	Ø 48.3 mm
PVD	Art. no.	Art. no.	Art. no.
copper	12.5502.000.33	12.5502.420.33	12.5502.480.33
black	12.5502.000.34	12.5502.420.34	12.5502.480.34

## Kronos, V4A



| Length: 65 mm  
| Height: 45 mm  
| Sales unit: 4 pieces

Connection	flat	Ø 42.4 mm	Ø 48.3 mm
	Art. no.	Art. no.	Art. no.
	12.5510.000.31	12.5510.420.31	12.5510.480.31

## Kronos, galvanised steel



| Length: 65 mm  
| Height: 45 mm  
| Sales unit: 4 pieces

Connection	flat	Ø 42.4 mm	Ø 48.3 mm
	Art. no.	Art. no.	Art. no.
	12.5510.000.81	12.5510.420.81	12.5510.480.81

## Kronos, RAL



| Length: 65 mm  
| Height: 45 mm  
| Sales unit: 4 pieces

Connection	flat	Ø 42.4 mm	Ø 48.3 mm
RAL	Art. no.	Art. no.	Art. no.
glossy	12.5510.000.83	12.5510.420.83	12.5510.480.83
structured matt	12.5510.000.86	12.5510.420.86	12.5510.480.86
matt	12.5510.000.88	12.5510.420.88	12.5510.480.88

## Kronos Cover Cap, Stainless Steel V4A



| Length: 65 mm  
| Height: 45 mm  
| Sales unit: 4 pieces

Connection	flat	Ø 42.4 mm	Ø 48.3 mm
	Art. no.	Art. no.	Art. no.
	12.5512.000.31	12.5512.420.31	12.5512.480.31

## Kronos Cover Cap, zinc-plated steel



| Length: 65 mm  
| Height: 45 mm  
| Sales unit: 4 pieces

Connection	flat	Ø 42.4 mm	Ø 48.3 mm
	Art. no.	Art. no.	Art. no.
	12.5512.000.81	12.5512.420.81	12.5512.480.81

## Kronos cover cap RAL



| Length: 65 mm  
| Height: 45 mm  
| Sales unit: 4 pieces

Connection	flat	Ø 42.4 mm	Ø 48.3 mm
RAL	Art. no.	Art. no.	Art. no.
glossy	12.5512.000.83	12.5512.420.83	12.5512.480.83
structured matt	12.5512.000.86	12.5512.420.86	12.5512.480.86
matt	12.5512.000.88	12.5512.420.88	12.5512.480.88

## Kronos cover cap PVD



| Length: 65 mm  
| Height: 45 mm  
| Sales unit: 4 pieces

Connection	flat	Ø 42.4 mm	Ø 48.3 mm
PVD	Art. no.	Art. no.	Art. no.
copper	12.5512.000.33	12.5512.420.33	12.5512.480.33
black	12.5512.000.34	12.5512.420.34	12.5512.480.34

## Kronos Inner Section without Cover Cap



- | Length: 65 mm
- | Height: 45 mm
- | Material: Steel/nickel, zinc-plated
- | Sales unit: 4 pieces

Connection	flat	Ø 42.4 mm	Ø 48.3 mm
	Art. no.	Art. no.	Art. no.
	12.5501.000.82	12.5501.420.82	12.5501.480.82

## Kronos glass support, lateral



Will you mount Kronos all by yourself?  
These glass supports offer a 100% slip protection without drill holes in the glass. The glass is perfectly held in place by these supports.

- | left and right each
- | Sales unit: 4 pieces



Model 7055	
	Art. no.
	90.7055.010.41

## Kronos glass support for floor glass clamp



Would you like to use the Kronos glass clamp as a floor clamp?  
No problem - with the aid of the glass support, the clamp is simply repurposed.

- | Sales unit: 4 pieces



Model 7055	
	Art. no.
	90.7055.020.41

## Kronos lock pin



Lock pins must be used for pre-wall installation.  
They secure the glass against slipping. The locking pin can be used later when the clamp is already closed.

- | Sales unit: 4 pieces

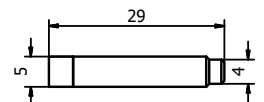

Model 5000	
	Art. no.
	92.5000.029.30



## Kronos, adjustable screw M8 x 20 mm



You haven't drilled straight into the post? No problem. Our adjustable screw can easily make up for small differences.

- | Finish exterior application: V4A (exterior)
- | Sales unit: 12 pieces

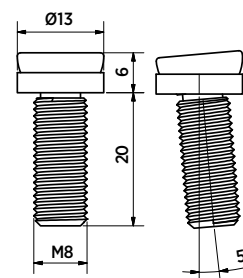

<b>Model 1050</b>	<b>AISI 316 (exterior)</b>
Art. no.	
91.1050.820.30	

## Kronos mounting tool



| Sales unit: 1 piece

<b>Model 0100</b>	
Art. no.	
90.0100.150.00	

## Kronos setting tool



| Sales unit: 1 piece

<b>Model 0100</b>	
Art. no.	
90.0100.155.00	

## Installation situation A - without lock pin

Installation situation A describes the use of clamps without lock pin. The glazing is realised with the aid of clamps and posts which are mounted on top of the base plate.

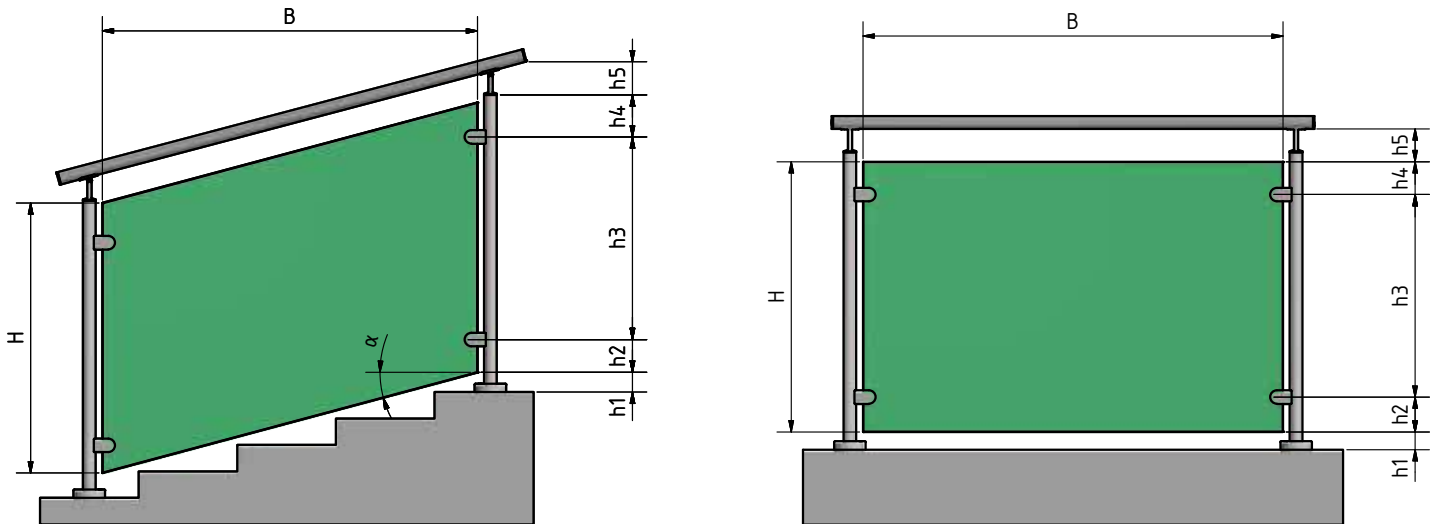

Designation	Meaning	Min. dimension [mm]	Max. dimension [mm]
H	Glass height	800	1100
B	Glass width	500	1600
h1	Floor upper edge - glass edge at bottom	10	120
h2	Glass edge at bottom - clamp centre axis at bottom	100	250
h3	Distance between clamps	500	700
h4	Glass edge on top - clamp centre axis on top	100	250
h5	Distance to glass edge on top - handrail	10-30	
$\alpha$	Angle to horizontal line	0°	41°

## Possible dimensions / wind loads as per type statics for exterior applications without posts

		Without lock pin						With lock pin					
		Laminated safety glass made of float glass			Laminated safety glass made of thermally toughened glass			Laminated safety glass made of tempered glass / tempered glass (heat soak test)			Laminated safety glass made of tempered glass / tempered glass (heat soak test)		
		2 x 6 mm	2 x 4 mm	2 x 5 mm	2 x 6 mm	2 x 4 mm	2 x 5 mm	2 x 6 mm	2 x 4 mm	2 x 5 mm	2 x 6 mm	2 x 4 mm	2 x 5 mm
Width: 500 mm	0.50 kN/m <sup>2</sup>	Complies	Complies	Complies	Complies	Complies	Complies	Complies	Complies	Complies	Complies	Complies	Complies
	1.00 kN/m <sup>2</sup>	Complies	Complies	Complies	Complies	Complies	Complies	Complies	Complies	Complies	Complies	Complies	Complies
	1.50 kN/m <sup>2</sup>	Complies	Complies	Complies	Complies	Complies	Complies	Complies	Complies	Complies	Complies	Complies	Complies
	2.00 kN/m <sup>2</sup>	Complies	Complies	Complies	Complies	Complies	Complies	Complies	Complies	Complies	Complies	Complies	Complies
	2.50 kN/m <sup>2</sup>	Complies	Complies	Complies	Complies	Complies	Complies	Complies	Complies	Complies	Complies	Complies	Complies
Width: 750 mm	0.50 kN/m <sup>2</sup>	Complies	Complies	Complies	Complies	Complies	Complies	Complies	Complies	Complies	Complies	Complies	Complies
	1.00 kN/m <sup>2</sup>	Complies	Complies	Complies	Complies	Complies	Complies	Complies	Complies	Complies	Complies	Complies	Complies
	1.50 kN/m <sup>2</sup>	Complies	Complies	Complies	Complies	Complies	Complies	Complies	Complies	Complies	Complies	Complies	Complies
	2.00 kN/m <sup>2</sup>	Complies	Complies	Complies	Complies	Complies	Complies	Complies	Complies	Complies	Complies	Complies	Complies
	2.50 kN/m <sup>2</sup>	Complies	Complies	Complies	Complies	Complies	Complies	Complies	Complies	Complies	Complies	Complies	Complies
Width: 1000 mm	0.50 kN/m <sup>2</sup>	Complies	Complies	Complies	Complies	Complies	Complies	Complies	Complies	Complies	Complies	Complies	Complies
	1.00 kN/m <sup>2</sup>	Complies	Complies	Complies	Complies	Complies	Complies	Complies	Complies	Complies	Complies	Complies	Complies
	1.50 kN/m <sup>2</sup>	Complies	Complies	Complies	Complies	Complies	Complies	Complies	Complies	Complies	Complies	Complies	Complies
	2.00 kN/m <sup>2</sup>	Complies	Complies	Complies	Complies	Complies	Complies	Complies	Complies	Complies	Complies	Complies	Complies
	2.50 kN/m <sup>2</sup>	Complies	Complies	Complies	Complies	Complies	Complies	Complies	Complies	Complies	Complies	Complies	Complies
Width: 1300 mm	0.50 kN/m <sup>2</sup>	Complies	Complies	Complies	Complies	Complies	Complies	Complies	Complies	Complies	Complies	Complies	Complies
	1.00 kN/m <sup>2</sup>	Complies	Complies	Complies	Complies	Complies	Complies	Complies	Complies	Complies	Complies	Complies	Complies
	1.50 kN/m <sup>2</sup>	Complies	Complies	Complies	Complies	Complies	Complies	Complies	Complies	Complies	Complies	Complies	Complies
	2.00 kN/m <sup>2</sup>	Complies	Complies	Complies	Complies	Complies	Complies	Complies	Complies	Complies	Complies	Complies	Complies
	2.50 kN/m <sup>2</sup>	Complies	Complies	Complies	Complies	Complies	Complies	Complies	Complies	Complies	Complies	Complies	Complies
Width: 1600 mm	0.50 kN/m <sup>2</sup>	Complies	Complies	Complies	Complies	Complies	Complies	Complies	Complies	Complies	Complies	Complies	Complies
	1.00 kN/m <sup>2</sup>	Complies	Complies	Complies	Complies	Complies	Complies	Complies	Complies	Complies	Complies	Complies	Complies
	1.50 kN/m <sup>2</sup>	Complies	Complies	Complies	Complies	Complies	Complies	Complies	Complies	Complies	Complies	Complies	Complies
	2.00 kN/m <sup>2</sup>	Complies	Complies	Complies	Complies	Complies	Complies	Complies	Complies	Complies	Complies	Complies	Complies
	2.50 kN/m <sup>2</sup>	Complies	Complies	Complies	Complies	Complies	Complies	Complies	Complies	Complies	Complies	Complies	Complies

complies with DIN 18008  
 does not comply with DIN 18008

# ONLEVEL

8, Alexandria Court  
Ashton Commerce Park  
Ashton-under-Lyne  
Lancashire OL7 0QN  
United Kingdom

T +44 0161 804 9500  
F +44 0161 804 9505

[info@onlevel-uk.com](mailto:info@onlevel-uk.com)  
[www.onlevel.com](http://www.onlevel.com)