

BERNINITM
F O U N T A I N S

ALBA FOUNTAIN
Owner's Manual



BERNINITM

F O U N T A I N S

PLEASE READ FIRST BEFORE RETURNING

**Please call us for assistance at 1+ (619) 449-2392
or email us at customer care@berninifountains.com**

Our Customer Care Department is available:

Monday - Friday 8:30am to 4:00pm PST, 11:30am to 7:00pm EST

If you have any questions regarding assembly, parts or operation, please visit our website at www.berninifountains.com. At berninifountains.com you will find instructional videos on how to assemble and operate your fountain and it will keep you up to date on our newest products.

This product comes with a one year limited warranty against materials and workmanship.

Please review the list of accessories included with your BerniniTM Fountain on the next page. Please note, images of parts are not to scale with one another.

About Alba:

Alba is a quaint city in Italy that is infamous for its truffles and gourmet cuisine. The Bernini Alba Cordless Fountain is the perfect addition to AL fresco dinner parties on the patio.

Parts for your Bernini™ Fountain:



AlbaTopper



3 Prong Foot



Infinity Bowl/Planter /Bird Feeder



Cap



Large Bowl



Base



Dancing Water Attachments



Leveling Shim

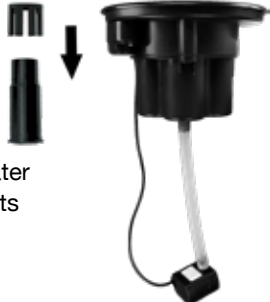

Battery Compartment, Water Tube & Water Pump

CONTENTS

- 1 Step 1: Base & Large Bowl**
- 2 Base & Bowl Locking System
- 3 Step 2: Alba Topper Installation**
- 4 Installing The Alba Topper
- 5 Step 3: Battery Installation**
- 6 Inserting Batteries Into The Battery Compartment
- 6 Installing Batteries
- 7 Assembly Of Battery Compartment Housing & Battery Cover
- 7 Assembly Of Water Pump & Tube To Battery Compartment
- 8 Changing Batteries
- 9 Step 4: Setting Up Your Fountain**
- 10 Fill Your Fountain
- 10 Operating Your Fountain
- 11 Dancing Water Attachments
- 12 Troubleshooting and Maintenance**
- 12 Cleaning Your Fountain
- 12 Cold Storage
- 12 Cleaning the Water Pump's Parts
- 12 Water Pump Impeller
- 13 Priming the Water Pump
- 13 Water Pump Connection
- 13 Using Leveling Shims
- 14 Troubleshooting Guide

Step 1:

Base & Large Bowl

You will need:



Base



Large Bowl

Remember if you need help contact Customer Care: 1+ (619) 449-2392



BERNINI | 1

Base & Bowl Locking System

A look at how the base & bowl locking system works on your Fountain.



Bottom of the Bowl

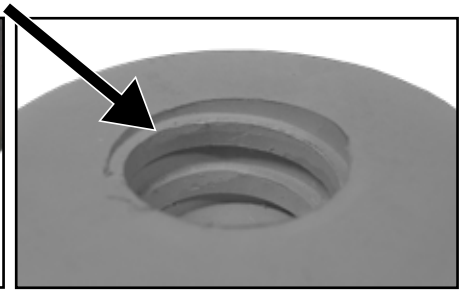

Top of the Base

Note: You will notice that there are threads on the bottom of the Large Bowl and there are corresponding threads in the top of the Base. These threads fit together securely when tightened.



Step 1: Be sure to place the Base of your fountain on a flat, firm surface.



Step 2: Align and connect the Large Bowl to the Base.



Step 3: Turn the Large Bowl and screw clockwise until tight but do not over tighten.



At this point, your fountain should look like the image to the right. Go to the next page to continue setting up your new Fountain.



Step 2:

Alba Topper Installation

You will need:



Assembled Base &
Large Bowl



Topper



Installing The Alba Topper

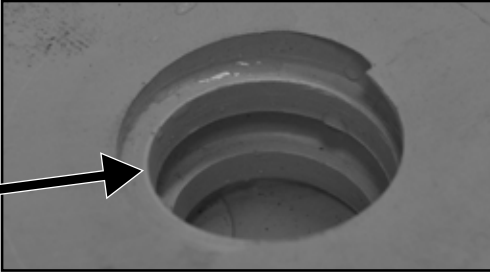

Inside of the Large Bowl

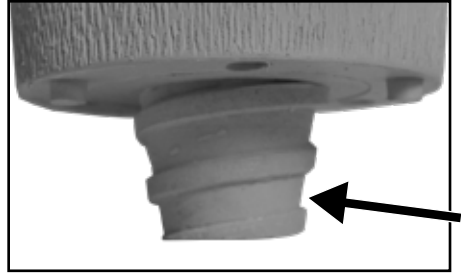

Bottom of the Topper

Note: Just as you installed the Large Bowl and the Base, you will notice that there are threads in the Bowl and there are corresponding threads in the bottom of the Topper. These threads fit together securely when tightened.

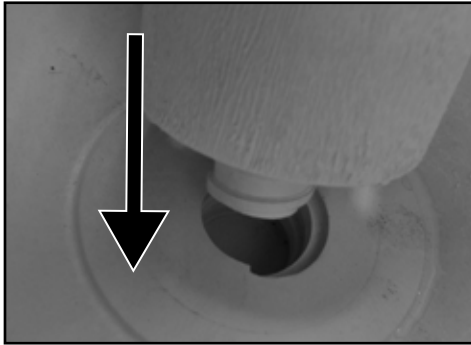

Step 1: Align the threads up and screw the Large Bowl and Topper together.

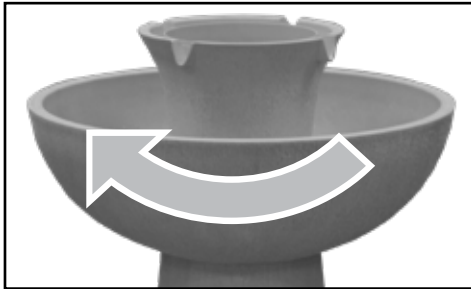

At this point, your fountain should look like the image on the right. Go to the next page to continue setup for your new Fountain.



Step 3:

Battery Installation

You will need:



Fountain
Assembled



Battery Compart-
ment, Water Tube
& Water Pump

Remember if you need help contact Customer Care: 1+ (619) 449-2392



BERNINI | 5

Inserting Batteries Into The Battery Compartment



Figure 1a



Battery Compartment Retaining
Screws X2
Figure 1b

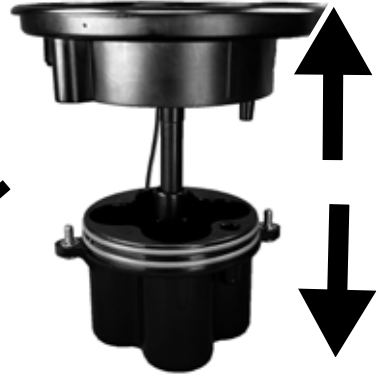

Figure 1c

Installing Batteries:

1. (If Battery Compartment & Water Pump are installed into the Topper) Lift out of the Topper (Figure 1a). Disconnect the Water Tube from the Battery Compartment (A Figure 3a).
2. Unscrew (counter clockwise) the Battery Compartment Screws, screws DO NOT come out of the battery compartment, when the screw continues to spin or you hear a click the screw is unscrewed completely, slip pump cable out of cable notch, and open cover (Figure 1b & 1c). Note: Cover fits tightly, may take some strength to pull apart
3. Fountain requires 4 D Batteries (Not Included), insert x2 D Batteries with the (-, Negative) side facing down in Battery Compartment (Figure 2a), negative side of the battery will be resting on the raised coil/spring. Then insert the other 2x D Batteries with the (+, Positive) side facing down in the Battery Compartment. (Figure 2a).
4. Reinstall the Fountain Top by aligning the locating dowel in the Battery Compartment and Fountain Top. Set the Battery Cover down onto the Battery Compartment ensuring the dowel sets into the alignment hole and that the pump wire is placed back in the cable notch. Apply pressure and tighten the Battery Cover Screws by turning clockwise. NOTE: Pressure must be applied to the Battery Compartment while tightening the screws to assure the compartment is properly sealed. If needed, while holding battery compartment, place it upside down on an even surface to tighten screws (Figure 2a, 2b & 2c).

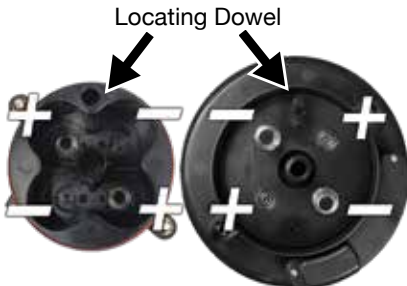

Figure 2a

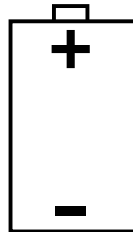

Figure 2b



Figure 2c



Assembly Of Battery Compartment Housing & Cover:



1. Place Battery Cover on Battery Compartment Housing. Turn over assembled Battery unit and place on a flat, level surface. Using a Phillips screwdriver (not included) first, tighten left screw down firmly.
2. After tightening the left screw, you will notice a small gap between the Battery Cover and the Battery Compartment Housing.
3. Using a Phillips screwdriver (not included) tighten the right screw down firmly.
4. After both screws have been tightened, you may notice a small gap between the Battery Cover and the Battery Compartment Housing.
5. Press down firmly on the bottom of the Battery Compartment Housing to help tighten the gap.
6. Using a Phillips screwdriver re-tighten the screws (left screw first, right screw second) to further tighten the gap between the Battery Cover and the Battery Compartment Housing.

Assembly Of Water Pump & Tube To Battery Compartment:

1. Take the Battery Compartment and Water Pump, connect one side of the Water Tube to the Water Pump and the other end to the bottom side of the Battery Compartment (A & B of Figure 3a).
2. Lower the Battery Compartment and Water Pump into the Alba Topper. Battery Compartment and Water Pump should be flush with Alba Topper (Figure 3b).

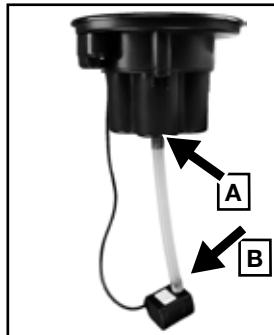

Changing Batteries:

1. Remove any Dancing Water Attachment, lift Battery Compartment and Water Pump out of the Fountain (Figure 4a). Ensure Battery Compartment and Water Pump are completely dry before opening Battery Compartment. It is important that no water enters the Battery Compartment.
2. See Installing Batteries Section above on how to reinstall batteries and reassemble.
3. Set the Battery Compartment and Water Pump back into the Fountain (Figure 4d).



Figure 4a

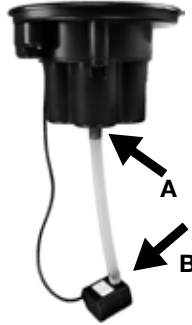

Figure 4b



Figure 4d



Figure 4c



At this point, your fountain should look like the image on the left. Go to the next page to continue setting up your new Fountain.



Step 4:

Setting Up Your Fountain

You will need:



Fountain
Assembled

Water To Fill Your Fountain



Dancing Water
Attachments



Fill Your Fountain

Fill the large bowl until the water is about 1 inch (2.5 centimeters) from the top of the bowl. After you have filled your fountain to dislodge any air bubbles from the pump, grab both sides of the large bowl and quickly shake your fountain for ten seconds. Press the button once to turn your fountain on. Water should be flowing from the top of your fountain. If water is not flowing, press the button once more to turn your fountain off and repeat the step above.

Operating Your Fountain

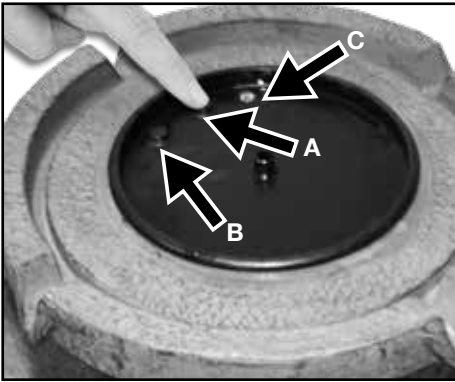

Figure 1a

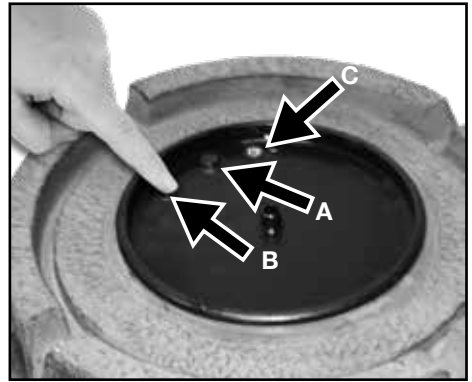

Figure 1b

Turn Fountain on and off: The A Button is the manual on and off button. With the Fountain off, press the A button, the fountain will run for a maximum of 6 hours or until the A button is pressed again which will shut the fountain off. Pressing the A button will cancel out any programs programmed into the B Button, and the B Button will need to be programmed again as desired (Figure 1a & 1b).

Programing The Fountain: After cycling through the A button which will clear out all programing. Press the B Button 1 time: the light (C Figure 1a & 1b), will flash once which will program the fountain for 1 hour and will run for 1 hour then turn off and will turn back on at the same time the next day for 1 hour. Press the B Button 2 times: the light (C Figure 1a & 1b), will flash twice which will program the fountain for 2 hours and will run for 2 hours then turn off and turn back on at the same time the next day for 2 hours. Press the B Button 3 times: the light (C Figure 1a & 1b), will flash three times which will program the fountain for 3 hours and will run for 3 hours then turn off and turn back on at the same time the next day for 3 hours. Press the B Button 4 times: the light (C Figure 1a & 1b), will flash four times which will program the fountain for 4 hours and will run for 4 hours then turn off and turn back on at the same time the next day for 4 hours. (Figure 1b). Pressing the B Button a 5th time will turn off and set the timer back to 1 hour and the timer can be then again as described above. Pressing the A Button during operation at anytime will turn the fountain off but will also turn off any programing.

Reset/Change the timer: The A Button once cycled (turned on and off) will clear out any timers programmed into the B Button. The Set the B Button Programing as in the "Programing The Fountain" Section above (Figure 1b).

Fully shut off and clear timer: The A Button once cycled (turned on and off) will clear out any timers programmed into the B Button (Figure 1a).



Dancing Water Attachments

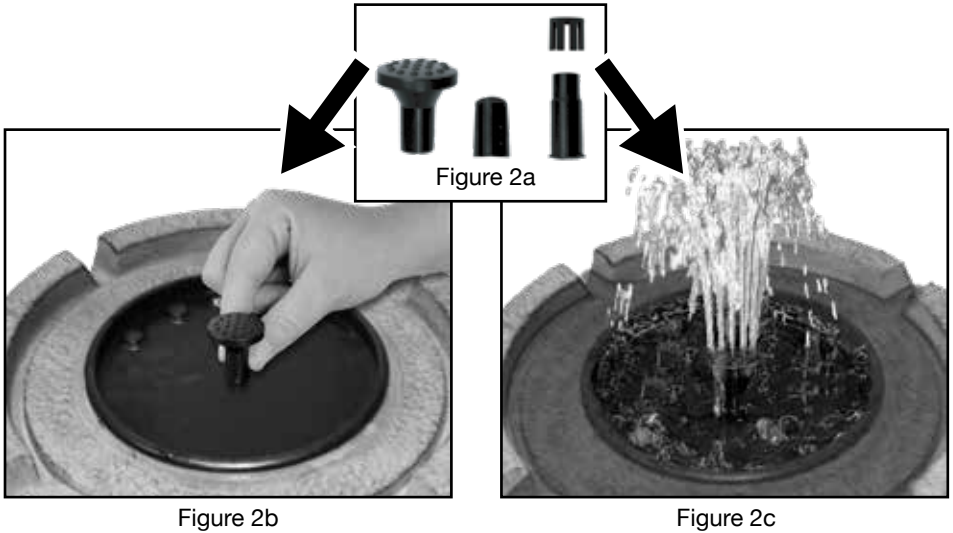

Figure 2b

Figure 2c

DANCING WATER ATTACHMENTS: (OPTIONAL): You can put any of the Dancing Water Attachments on the Fountain whether the Fountain is running or is not running. Select one of the Dancing Water Attachments and place on the outlet in the middle of the Battery Compartment (Figure 2a, 2b & 2c).

NOTE: Please be aware that there is over spray that occurs while using the Dancing Water Attachments.



You can now try your Bernini™ Fountain to see if everything is working correctly! Turn your fountain on and you should see water flowing from the outlet on the top of the Alba Topper. **If water is not flowing, please refer to the “Priming The Water Pump” section.**

The following section covers any Troubleshooting and Maintenance issues as needed.



Step 5:

3-in-1 Infinity Bowl/ Bird Feeder/ Planter Bowl

You will need:



3 Prong Foot



Infinity Bowl/Planter
/Bird Feeder



Cap





Figure 1

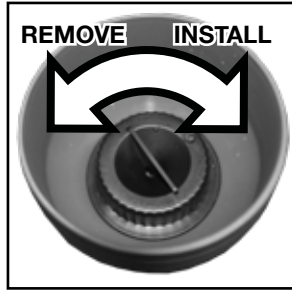

Figure 2

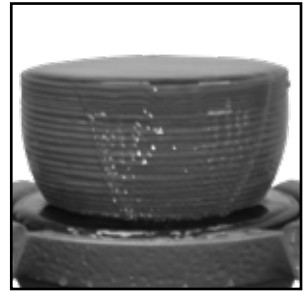

Figure 3

Infinity Bowl

To install the Bowl as an Infinity Pool, take the Bowl and the Cap, screw the Cap into the inside of the bowl turning clockwise (Figure 1, 2 & 3). Do not over tighten. Place infinity Bowl on the fountain spout just as you would place one of the Dancing Waters Attachments. Push button to enjoy your fountain.

How the Self-Watering System Works

Your self-watering garden fountain waters from the bottom up. Do not worry if you do not see the top soil becoming wet after the first day or two of use. The bottom layer of the soil will be watered every time you run the fountain. After approximately 3 days, the soil will reach its maximum water level. The water will steadily climb to just below the surface of the soil, while your fountain is on, the water level rises, watering your plant from bottom to top. (Figure 5).

When your fountain is off, the roots of your plant will be aerated to produce strong healthy roots. When the fountain is on, the water level will rise above the surface of the top planter bowl, saturating the soil (Figure 6).

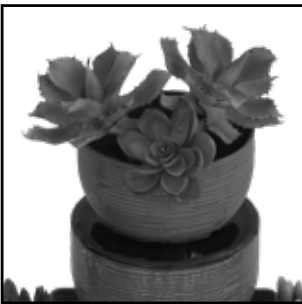

Figure 4

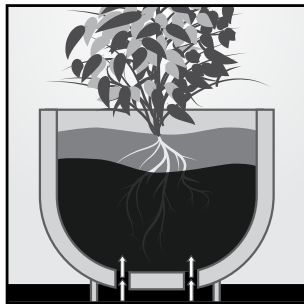

Figure 5



Figure 6



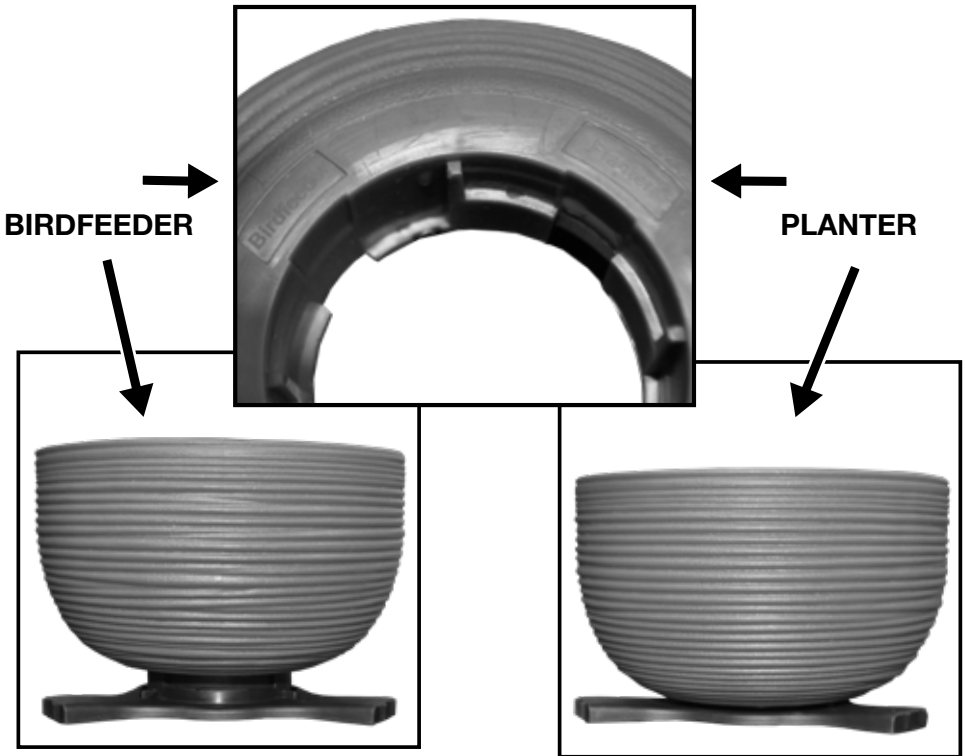

Figure 7

Figure 8

Planter

To install the Bowl as a Planter, take the Bowl and 3 Prong Foot, line up the arrows (Figure 12 white circle) on the 3 Prong Foot to the “Planter” position located on the bottom of the bowl (Figure 8). Align the arrows and push firmly to lock in place. There are 2 small holes on the bottom of the planter that will allow water to be absorbed from the bottom of the bowl when fountain is running (Figure 4, 5 & 6). Place the Bowl and Foot on top of the fountain. Be sure not cover the button or light on top of the fountain. Push on 3 Prong Foot to secure. Once Planter is in place use your favorite soil (do not over pack) and plant your new addition to your family. Push button to enjoy your fountain.





Figure 9

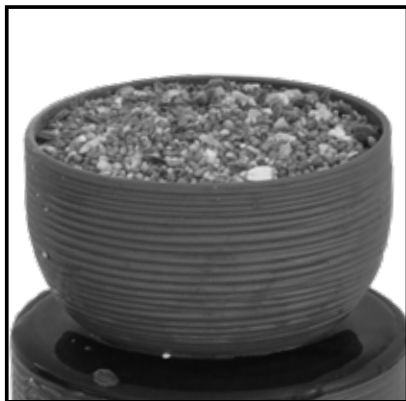

Figure 10

Bird Feeder

To install the bird feeder, take the Infinity bowl and 3 prong foot, line up the arrows (Figure 11 white circle) on the 3 prong foot to the bird feeder position located on the bottom of the bowl (Figure 9 & 10). Align the arrows and push firmly to lock in 3 prong foot. Place the bowl and foot on top of the fountain. Be sure not cover the button or light on top of the fountain. Push on 3 prong foot to secure. Fill bowl with bird food, avoid over-filling to prevent bird seed from going in your fountain. Push button to enjoy your fountain.

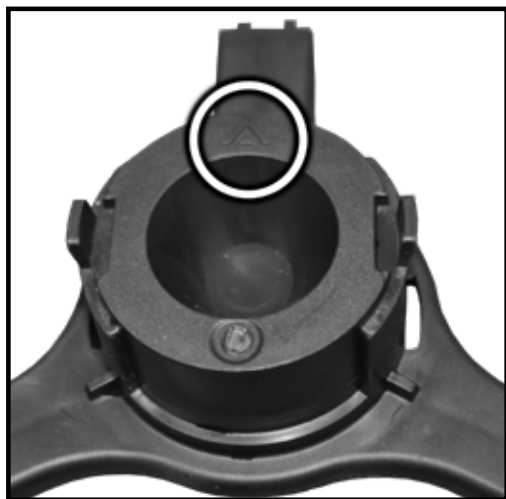

Figure 11



Troubleshooting and Maintenance

Cleaning Your Fountain

In order to keep your Fountain in tip-top shape and for a prolonged life, it is best if your Fountain and the bowl or water container that the Fountain is placed in are cleaned periodically. To clean your fountain, drain of all water and disassemble. Use a mild soap and a soft cloth to clean the parts of your Fountain. **DO NOT SCRUB YOUR FOUNTAIN, AS THIS COULD CAUSE DAMAGE TO THE FINISH OF YOUR BERNINI™ FOUNTAIN.**

Cold Storage

Turn power off, remove from container, clean and dry the Fountain of all water. Remove the batteries for long term storage and bring it indoors. (Now is a great time to clean the pump to remove any debris that may have accumulated throughout the year).

Cleaning the Water Pump's Parts

After about six weeks of usage, you may want to clean the water pump's impeller to keep your Bernini™ Fountain in tip-top shape. You will need to drain your fountain of all water prior to cleaning the water pumps' parts.

Water Pump Impeller

The impeller inside of the water pump is what pushes water up through your fountain, allowing you to enjoy the soothing sounds and wonderful sights of your Bernini™ Fountain. After long periods of usage, this part will need to be cleaned to make sure your fountain runs optimally.

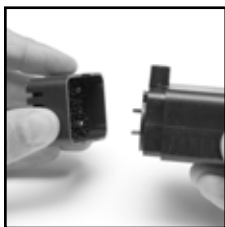

Begin by disconnecting the pump from the water tube.

Step 1: Remove the front of the water pump by grabbing the sides of the front panel and pull it off the unit.



Step 2: Remove the impeller chamber cover. This is tightly fitted on to the impeller chamber, but will come off.

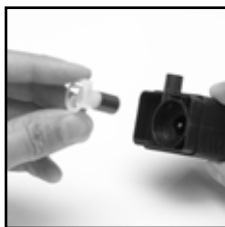

Step 3: Remove the impeller from its chamber.



Step 4: Rinse the impeller until all debris has been removed. Then replace the impeller in the impeller chamber, put the impeller chamber back on and then replace the pump's front panel.



Priming The Water Pump

If you find the Water Pump is running, but water is not flowing from your Fountain, you can try priming the Water Pump:

Turn off Fountain, grab both sides of the Fountain and quickly shake your Fountain for ten seconds. This is to dislodge any air bubbles that may be caught in your Water Pump. Press the button to turn your Fountain on.

Water should be flowing from the top of your Fountain. If water is not flowing, press and hold button for over 2 seconds again to turn your Fountain off, and repeat the step above.

Water Pump Connection

If your fountain's water pump becomes disconnected use these instructions to reconnect your water pump.



Before beginning, remove the Battery Assembly from Alba Topper. **Step 1:** Lift the Battery Assembly out of the Alba Topper to access pump and tube.



Step 1: Rest the Battery and Pump Assembly on its side. Check the connection at the top of the water tube at the Battery Housing. Re connect if needed.

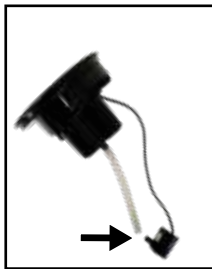

Step 2: Check the connection at the bottom of the water tube at the Water Pump. Re connect if needed.



Step 3: Reassemble the Battery and Pump Assembly in reverse of removal or refer to the instructions in the Battery and Pump Assembly section of this manual.

Using Leveling Shims

If you are having trouble getting water to flow evenly off of the edge of your fountain, you may need to level the surface that your fountain is placed on. With the included leveling shims, you do not need to move your fountain, just follow the instructions below to get even water flow.



Place the shim underneath the base on the opposite side that is not flowing as strongly as the other sides.



Grasp the shim and break it on the crease closest to the end of the base.



Once the shim is broken, it will be hidden but will level your fountain.



Troubleshooting Guide

PROBLEM	SOLUTION
Fountain is not working	Check that batteries have a full charge: See Changing Battery Section.
Pump not working	Check that batteries have a full charge: See Changing Battery Section.
Water Not Flowing	Prime Pump as instructed. (Refer to priming the water pump)
	Add Water
	Check to see that pump tubes are connected
	Check to see that the pump and pump tubes are clear of debris.
	Check batteries are installed correctly: See Installing Battery Section.
	Check that batteries have a full charge: See Changing Battery Section.
	Pump is on but no water flow: Check water level.
	Pump is on but no water flow: Check pump is free of debris, kinks or obstructions. See Troubleshooting section.
Loud Pump	Pump is on but no water flow: Check water tube is connected properly. See Base and Fountain Bowl Installation Section 1.
	Prime Pump as instructed. (Refer to priming the water pump).
Fountain Settings not working	Check water level. Ensure pump free of debris.
	Check that batteries have a charge: See Changing Battery Section.
Low Water Flow	Check that batteries have a charge: See Changing Battery Section.
	Pump is on but low water flow: Check pump is free of debris, kinks or obstructions. See Troubleshooting section.
	Pump has low water flow: Check water level.
	Pump is on but low water flow: pump is cavitating. See Priming The Water Pump Section.
Loud Sound	Loud sound and weak flow: Air in pump: See Priming The Water Pump Section.
	Loud sound and weak flow: Check pump is free of debris, kinks or obstructions. See Troubleshooting section.
Suddenly Stops	Pump suddenly stops: Check pump is free of debris, kinks or obstructions. See Troubleshooting section.



BERNINITM

F O U N T A I N S

LIMITED ONE YEAR WARRANTY

This product has a one year limited warranty on all materials and workmanship. BerniniTM warrants the original purchaser of this product that the product will be free from manufacturing defects in workmanship and material for a period of one (1) year from the date of original purchase. If within one (1) year this product fails due to defect in material or workmanship, BerniniTM will repair, replace or supply any defective part at their discretion. The purchaser must contact BerniniTM and provide a description of the defective part, including digital pictures if requested, with this original purchase documentation as validation of warranty coverage.

This warranty does not cover or apply to: (a) damage to the product due to misuse, mishandling, and abuse, (b) products not used in accordance with instructions, (c) product not assembled or installed according to instructions, and (d) normal wear and tear.

Call us for assistance at 1+ (619) 449-2392 or you can email us at:
customercare@berninifountains.com

Our Customer Care Department is available:

Monday - Friday 8:30am to 4:00pm PST / 11:30am - 7:00pm EST



IMPORTANT BATTERY SAFETY INSTRUCTIONS

DANGER: Do not store battery in an airtight container as it may cause an explosion.

WARNING: When using electric devices, basic safety precautions should always be followed to reduce the risk of fire, electric shock and personal injury, including the following:

- WARNING:** 1. Do not incinerate the battery even if it is severely damaged or is completely worn out. The battery can explode in a fire. Check with municipal codes in your area for possible special disposal instructions.
2. If liquid leaks from the battery cell, discontinue use immediately and dispose of properly.
 3. Use only 4-1.5V D Cell Batteries.
 4. Do not attempt to disassemble, remodel or destroy the batteries, as it may cause battery leakage, fire, or bursting.
 5. Never dispose of batteries in the garbage. Disposal of batteries in the garbage is unlawful under state and federal environmental laws and regulations. Always take used batteries to your local battery-recycling center.

Santee, California 92071

World Wide Patents Pending

Email: customercare@berninifountains.com

On the web: www.berninifountains.com

Facebook & Pinterest: Bernini Fountain Company

Instagram: @berninifountains Twitter: @yrdllc

© Yeiser Research & Development, LLC; 2021. All rights reserved.

Made in China
Designed in the USA

001221 BAFI rev 1L us