

# BERNINI<sup>TM</sup>

F O U N T A I N S



## AMORE HYBRID FOUNTAIN, BIRD FEEDER & PLANTER

Owner's Manual

# BERNINI<sup>TM</sup>

F O U N T A I N S

## **PLEASE READ FIRST BEFORE RETURNING**

**Please call us for assistance at 1+ (619) 449-2392  
or email us at [customer care@berninifountains.com](mailto:customer care@berninifountains.com)**

**Our Customer Care Department is available:**

**Monday - Friday 8:30am to 4:00pm PST, 11:30am to 7:00pm EST**

If you have any questions regarding assembly, parts, or operation, please visit our website at [www.berninifountains.com](http://www.berninifountains.com). You will find instructional videos on how to assemble and operate your fountain, and keeps you up to date on our newest products. You can also email us with any questions you have.

This product comes with a one year limited warranty against materials and workmanship.

**Please review the list of accessories included with your Bernini<sup>TM</sup> Fountain on the next page. Please note, images of parts are not to scale with one another.**

# Contents

<b>1</b>	<b>Step 1: Base and Large Bowl</b>
2	Bowl Locking System
<b>4</b>	<b>Step 2: Fountain Bowl Installation</b>
<b>7</b>	<b>Step 3: Battery &amp; Solar Installation</b>
8	Connecting The Battery and Solar Panel
10	Solar Panel Assembly
10	Solar Panel Installation
11	Inserting Battery Compartment Door
11	Removing The Battery Compartment Door
<b>12</b>	<b>Step 4: Setting Up Your Fountain</b>
13	Fill Your Fountain
13	Operating Your Fountain
<b>16</b>	<b>Step 5: Installation Instructions for Decor Tops</b>
17	Dancing Water Feature Installation
17	Dancing Water Feature and Spray Pattern
<b>18</b>	<b>Planter/Bird Feeder/Vanishing Edge Bowl Installation</b>
18	Vanishing Edge Bowl Installation
18	Bowl Feeder Installation
19	Planter Installation
<b>20</b>	<b>Troubleshooting and Maintenance</b>
20	Cleaning Your Fountain
20	Cold Storage
20	Recharging Your Battery
21	Cleaning The Water Pump's Parts
21	Water Pump Air Filters
21	Water Pump Impeller
22	Priming the Water Pump
23	Using Leveling Shims
23	Weighing Down Your Fountain
24	Water Pump Connection
24	Troubleshooting Guide

# Parts to your new Bernini™ Fountain:



Large Bowl



Base



Battery Compartment Door



Fountain Tier with Water Pump Installed



Planter/Bird Feeder/Vanishing Edge Bowl



Rubber Plug



Foam Ring



Foam Ring Center Plug



Dancing Water  
Attachment



Connection Port



Rechargeable  
Battery



Solar Panel



Bird Seed  
Bowl



Leveling Shim



Solar Panel  
Stakes



Battery Charger



## How The Hybrid System Operates

Welcome to Bernini's new Hybrid System! The Hybrid System is designed to prolong the run time of your fountain between recharging your battery. The Hybrid System is a combination of Bernini's BA-152 high-capacity rechargeable battery and a computer controlled, high-capacity solar assist system. For best results, it is best to start with a fully charged battery. The Hybrid System will continually top off your battery in between uses. The battery will still need to be recharged however, the time between recharges can now be prolonged depending on the amount of sunshine the solar panel is exposed to. Please note, the time between recharges will vary based on the amount of sun exposure and how often you use your fountain. When the battery runs out of charge, simply follow the battery charging instructions to continue enjoying your Bernini Hybrid Fountain.

On behalf of Bernini Fountains, thank you for your purchase of a new Bernini Hybrid Fountain. Simply follow these instructions for the assembly of your new fountain, and if you have any problems or issues please don't hesitate to call our Customer Care Team at 1+ (619) 449-2392

# Step 1:

## Base & Large Bowl

You will need:



Base



Large Bowl



# Bowl Locking System

A look at how the bowl locking system works on your Fountain.

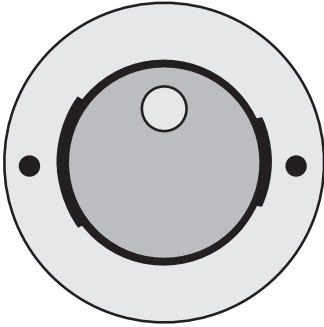

**Bottom of large bowl**

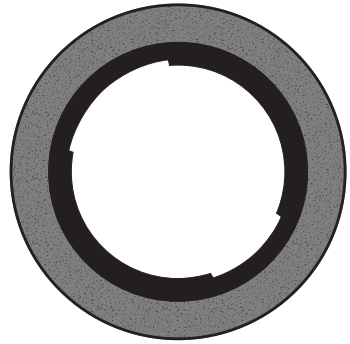

**Top of base**

**Note:** You will notice that there are two different sized tabs on the bottom of the Large Bowl and there are two corresponding grooves in the top of the Base. These tabs fit together and lock when turned clockwise.



**Step 1:** Make sure to place the Base of your Fountain on a flat, firm surface.



**Step 2:** Apply downward pressure by stepping on the edge of the Base to prevent it from turning.

Align and connect the Large Bowl to the Base.



**Step 3:** Turn the Large Bowl a quarter turn clockwise to lock it into place.







At this point, your fountain should look like the image below. Go to the next page for the next step to setup your new Bernini™ Fountain.



# Step 2:

## Fountain Bowl Installation

You will need:



Assembled Base  
& Large Bowl



Fountain Tier  
with Water Pump  
Installed



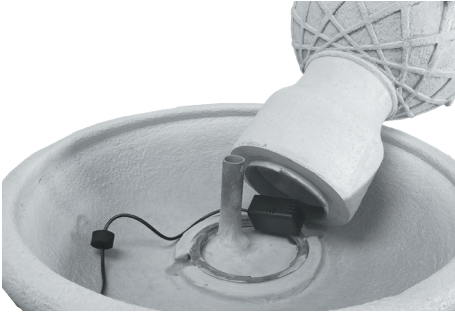

For the next step, the Fountain Tier will install into the middle of the Large Bowl assembled in step 1. Rest the Fountain Tier on the side of the large bowl.

**Step 1:** Feed the Water Pump cord down the pipe. The cord will be connected to the Connection Port at a later step.

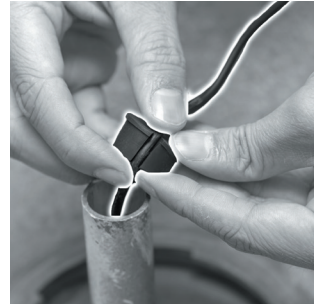
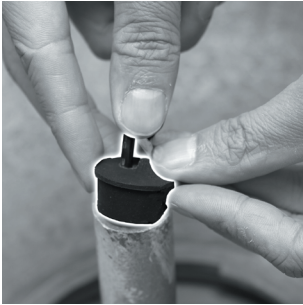

**Step 3:** Firmly press the plug into the pipe in the middle of the Large Bowl.

***If you are having trouble pressing the plug into the pipe, you can rub a small amount of soapy water on the plug to help it slide into place.***

**Step 4:** To ensure that you have a good seal, make sure the plug fits snugly as pictured above.

**NOTE:** If the cables slip out of the rubber stopper, you can press the cables into the slot in the side of the rubber stopper. Maneuver the cord to fit snugly inside the hole that is located in the center of the rubber stopper.

**If your Fountain came with the Water Pump disconnected from the tube inside of the Fountain Tier, refer to the “Water Pump Connection” section of this manual for instructions on how to connect the Water Pump to the Fountain Tier.**



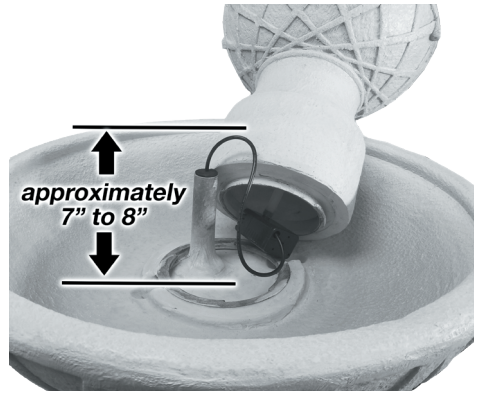
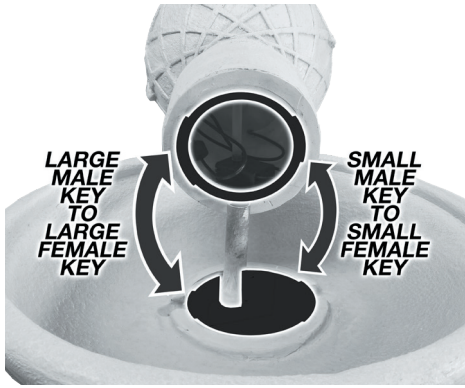

**Step 5:** Just like the large bowl and base, the fountain bowl uses a key system that will lock it to the middle of the large bowl.

**Be sure to leave approximately 7 to 8 inches (18 to 20cm) of slack in the cords coming from the water pump so the pump will sit on the bottom of the large bowl when the fountain bowl is assembled.**



**Step 6:** Connect the Fountain Tier to the Large Bowl and turn the Fountain Tier about a quarter turn clockwise to lock it into place. To keep the base from turning rest your foot on the base to assist in locking the fountain tier in place.



At this point, your Fountain should look like the image on the left. Go to the next page for the next step to setup your new Bernini™ Fountain.



# Step 3:

## Battery & Solar Installation

You will need:



Fountain  
assembled



Connection Port



Solar Panel



Battery  
Compartment  
Door



Rechargeable  
Battery



Solar Panel  
Stakes



# Connecting The Battery and Solar Panel

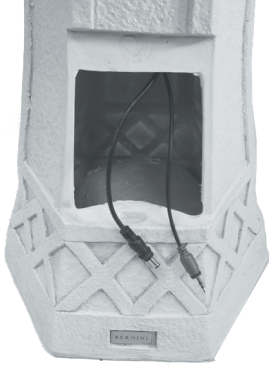

**Step 1:** In the open Battery Compartment, you will see two cords hanging down that you must connect to the Connection Port.

**If you do not see the two cables inside the battery compartment,** reach up into the Base and gently pull them down until they are hanging inside the Battery Compartment.

**NOTE: USE CAUTION WHEN REACHING INSIDE THE BATTERY COMPARTMENT OR PLACING BATTERY INSIDE. DUE TO THE MANUFACTURING PROCESS THERE MIGHT BE SHARP EDGES.**

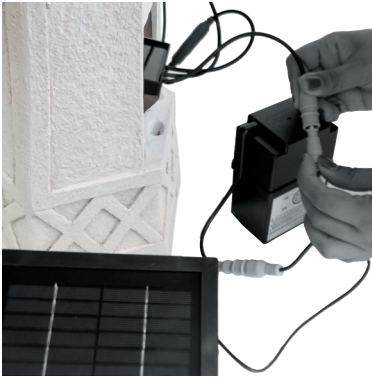

**Step 2:** Using the cords from inside the base and the cords from the Battery and Solar Panel, connect the color coded cords to their corresponding receptacles.

Use Diagram 1 for a more in depth explanation on connecting the Battery.

Diagram 1.

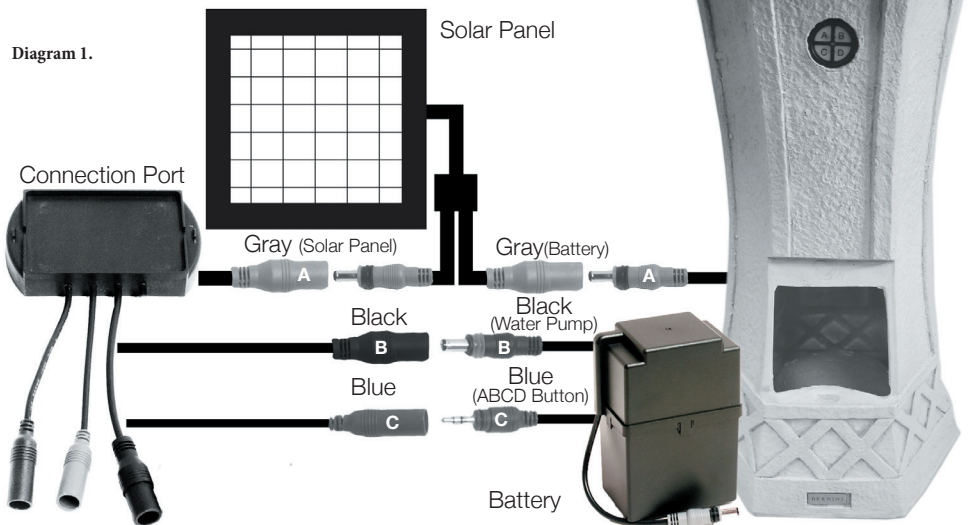

## Connecting The Battery and Solar Panel (Cont.)

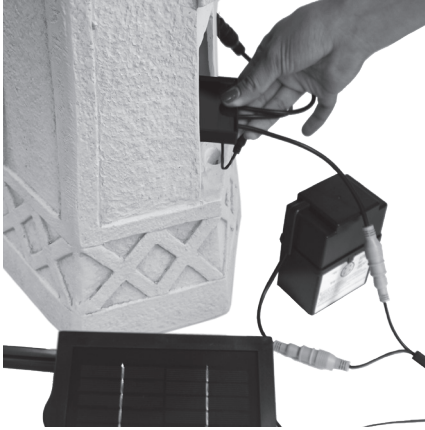
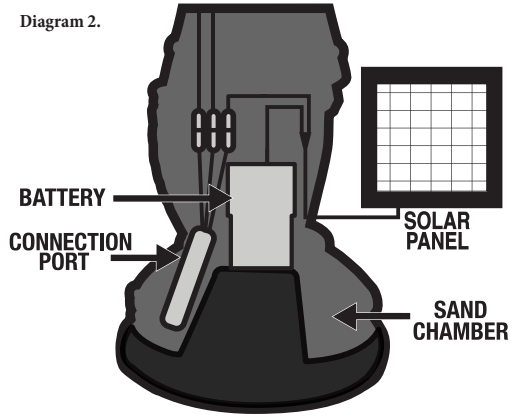

Diagram 2.



**Step 3:** Place your Connection Port inside the designated angled area located at the back of your Fountain Base. (Diagram 2)

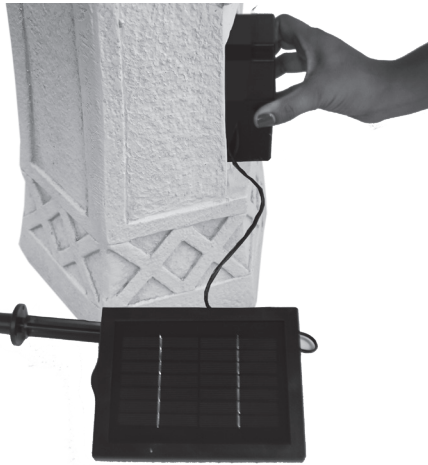
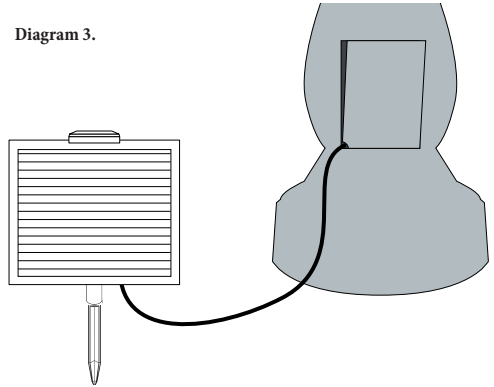

Diagram 3.



**Step 4:** Place the Battery inside of the compartment in front of the Connection Port (Diagram 2). There is a notch in the lower corner of the Battery Compartment Door that allows for the Solar Panel wire to extend out from the battery compartment door (Diagram 3). **DO NOT PLACE BATTERY UPSIDE DOWN INSIDE OF BATTERY COMPARTMENT.** **Note:** Installing the Battery Door will be shown in a later step.



# Solar Panel Assembly

## Step 1

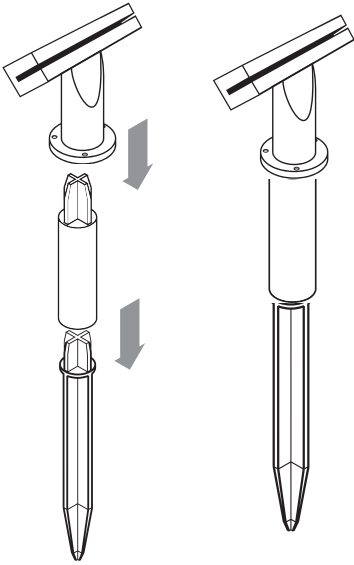

Figure 1a

Figure 1b

**Step 1:** Assemble the 3 sections of the Solar Panel Stakes as shown in figure 1a. Slide the 3 sections together tightly as shown in figure 1b.

## Step 2

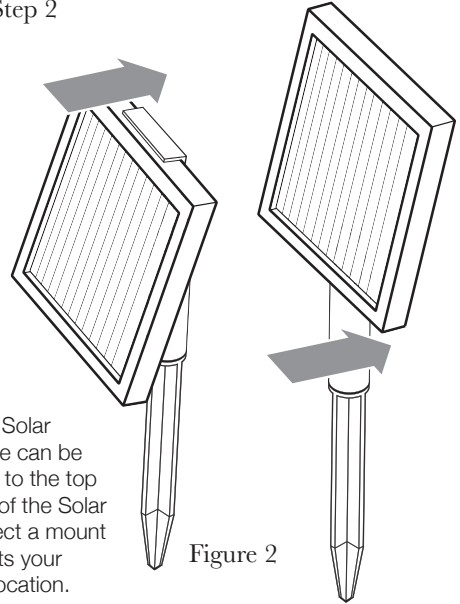

Figure 2

Top Mount

Bottom Mount

**Note:** The Solar Panel Stake can be connected to the top or bottom of the Solar Panel. Select a mount that best fits your fountains location.

**Step 2:** Slide the top section of the stake onto the edge of the Solar Panel as shown in figure 2. This is a slip fit and will firmly hold the Solar Panel into place.

# Solar Panel Installation

**Make sure to place the solar panel in a spot that gets plenty of sun to power your fountain.**

Push the stake assembly into soft dirt until the stake assembly, with solar panel attached, can securely stand upright. If soil is hard, you may use a screw driver to start the hole for the panel stakes.

Always angle the solar panel towards the sun to maximize exposure to sunlight that is required to power fountain.

For optimal power you will need to rotate and or angle the solar panel ensuring the sun has the most direct exposure on the panel.

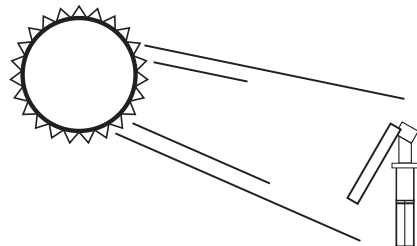

**Note:** The installation of the Solar Panel can be located approximately up to 6 ft away from your fountain (about the length of the cord). Make sure to use caution when mowing or working with tools in the area of the solar panel cord to avoid cutting your solar panels cord.





# Inserting the Battery Compartment Door

After you have connected the cables inside your Fountain to the Rechargeable Battery, you should then place the Battery Compartment Door on the Base of the Fountain.

**NOTE:** Ensure the solar panel cord is placed in the notch on the battery compartment door (arrow) prior to closing. Make sure not to pinch the cord.

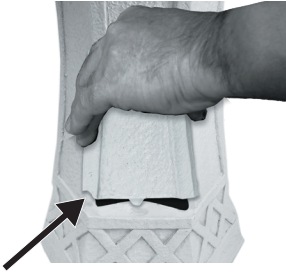

**Step 1:** Start by lining up the notch on the bottom of the Battery Compartment Door with the notch in the bottom of the Battery opening.

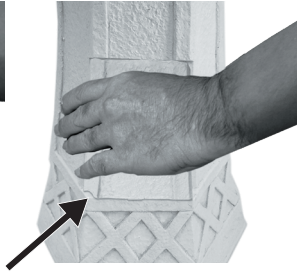

**Step 2:** Push the Battery Compartment door in toward the Base. You will know it is in position when the magnet locks the door in place.



Once the door is in place, you may notice a small notch in the bottom left corner of the Battery Compartment Door. This is for the Solar Panel cord.

# Removing the Battery Compartment Door

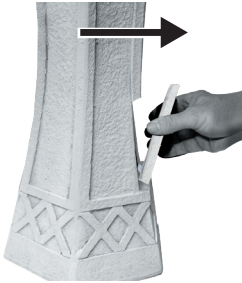

**Step 1:** Carefully disconnect the Battery Compartment Door from the base by gently pulling outward from the top.

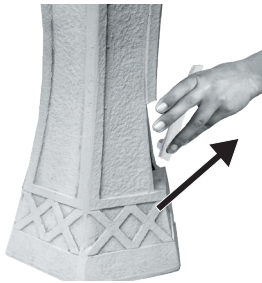

**Step 2:** Then, pull the Battery Compartment Door up and out to remove from the Base.



**DO NOT OVER EXTEND THE BATTERY COMPARTMENT DOOR BY PULLING DOWN!**

This may cause damage to your new Bernini™ Fountain.



At this point, your fountain should look like the image on the left. Go to the next page for the next step to setup your new Bernini™ Fountain.



# Step 4:

## Setting Up Your Fountain

You will need:



Fountain Assembled

Water To  
Fill Your  
Fountain



## Fill Your Fountain

Fill the Fountain Tier until water pours over the spouts. Then fill the Large Bowl until the water is about 1 inch (2.5 centimeters) from the top of the bowl.

After you have filled your Fountain, grab both sides of the Large Bowl and quickly shake your Fountain for ten seconds. This is to dislodge any air bubbles that may be caught in your Water Pump. Press the C button once to turn your Fountain on. Water should be flowing from the top of your fountain. If water is not flowing, press the C button once more to turn your Fountain off, and repeat the step above.

### IF YOUR FOUNTAIN IS MAKING A LOUD NOISE, DON'T PANIC!

This just means that there are air bubbles stuck in the Water Pump. Your pump will not be harmed and you can easily fix this issue. You can try priming the Fountain again by repeating the steps above however, if the problem still persists, refer to the "Priming The Water Pump" section of this manual for instructions on how to prime the Water Pump.

## Operating Your Fountain

The on-board control panel is located towards the top of the base, just below the Large Bowl. See the diagram below to see how the all-new on-board controls work for your Bernini™ Fountain.

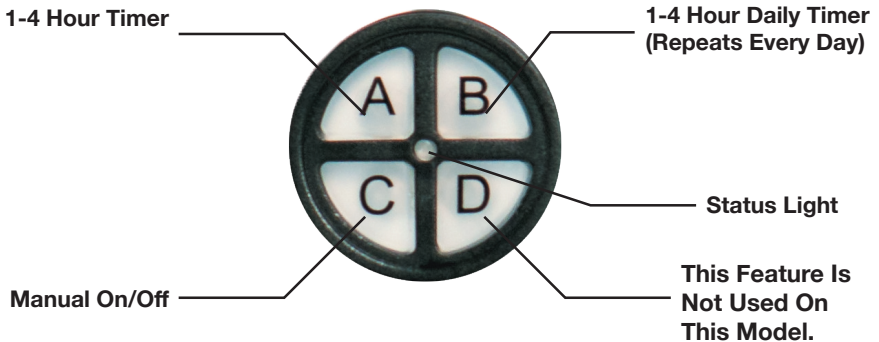

BUTTON	DESCRIPTION
A (1-4 Hour Timer)	<p>Runs the fountain for 1-4 hours with automatic shut off.</p> <p><b>One hour operation:</b> press the A button once for your fountain to turn on with an automatic shut-off after one hour of operation.</p> <p><b>Two hour operation:</b> press the A button twice and your fountain will automatically shut-off after two hours of operation.</p>



BUTTON	DESCRIPTION
<p><b>A</b> (1-4 Hour Timer) (continued)</p>	<p><b>Three hour operation:</b> press the A button three times and your fountain will automatically shut-off after three hours of operation.</p> <p><b>Four hour operation:</b> press the A button four times and your fountain will automatically shut-off after four hours of operation.</p> <p><b>How To Use This Function:</b></p> <ol style="list-style-type: none"> <li>1. Press the A button one, two, three or four times to turn your fountain on for the desired automatic run time.</li> <li>2. The Status Light will blink once for each hour you have selected to confirm your fountain's 1-4 Hour Timer, up to four hours.</li> <li>3. At the end of the desired interval, your fountain will automatically turn off.</li> </ol>
<p><b>B</b> (1-4 Hour Daily Timer)</p>	<p><b>This function is the same as the 1-4 Hour Timer (button A) except with the added feature of automatically turning your fountain on at the same time the next day for the interval you selected.</b></p> <p><b>One hour operation:</b> press the B button once for your fountain to turn on with an automatic shut-off after one hour of operation. This will repeat daily at the same time each day.</p> <p><b>Two hour operation:</b> press the B button twice and your fountain will automatically shut-off after two hours of operation and repeat daily at the same time.</p> <p><b>Three hour operation:</b> press the B button three times and your fountain will automatically shut-off after three hours of operation and repeat daily at the same time.</p> <p><b>Four hour operation:</b> press the B button four times and your fountain will automatically shut-off after four hours of operation and repeat daily at the same time.</p> <p><b>How To Use This Function:</b></p> <ol style="list-style-type: none"> <li>1. Select the amount of time you would like the fountain to run by pressing the B button one, two, three or four times.</li> <li>2. Your fountain will then run for the selected amount of time and at the end of the selected duration it will automatically turn off. Then your fountain will automatically turn on at the same time the next day for the run time duration you selected.</li> </ol>



BUTTON	DESCRIPTION
<b>B</b> (1-4 Hour Daily Timer) <i>(continued)</i>	<b>Example:</b> If you turn on your fountain, choose a two hour run time by pressing the B button twice at 5pm, your fountain will turn off at 7pm and turn on again the next day at 5pm and run for two hours automatically.
<b>C</b> (Manual On/Off)	Turns the fountain on and off without any timer. Can be used when extended run times are desired. Will also limit the battery life as the battery was designed to run in four hour increments. <b>Note:</b> Fountain will run until the battery loses its charge.
<b>D</b>	This feature is not used on this model.
Status Light	Status light will blink for the number hours you have selected when using the timer functions (buttons A and B).



You can now try your Bernini™ Fountain to see if everything is working correctly! Turn your Fountain on and if you see water flowing from the outlet in the middle of the Fountain Tier, go to the next page and select one of the many decorative options for your fountain. **If water is not flowing, refer to the “Priming The Water Pump” section of this manual for instructions on how to prime the Water Pump.**



# Step 5:

## Installation Instructions for Decor Tops

### You will need:



Bird Seed  
Bowl



Foam Ring  
Center Plug

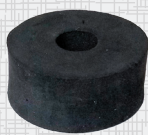

Foam Ring



Rubber Plug



Planter/Bird  
Feeder/Vanishing  
Edge Bowl



Dancing Water  
Attachment



# Dancing Water Feature Installation



**Step 1:** Find the Dancing Water attachment.



**Step 2:** Start by attaching the Dancing Water attachment to the outlet in the middle of the fountain bowl.

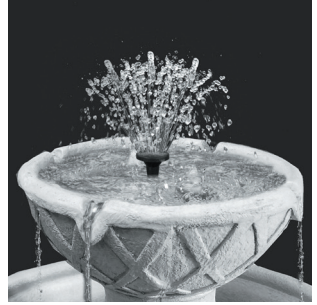

**Step 3:** Enjoy the relaxing and calming sound of your new Bernini™ Fountain.

# Dancing Water Feature and Spray Pattern

Dancing Water Attachment



At this point, your Fountain should look like the image above.



# Planter/Bird Feeder/Vanishing Edge Bowl Installation

## Vanishing Edge Bowl Installation

To prepare as the Vanishing Edge Bowl start by installing the Foam Ring and Rubber Plug into the bottom.

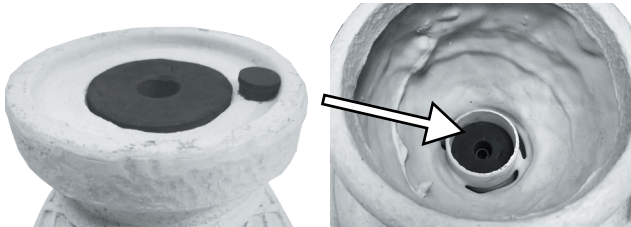
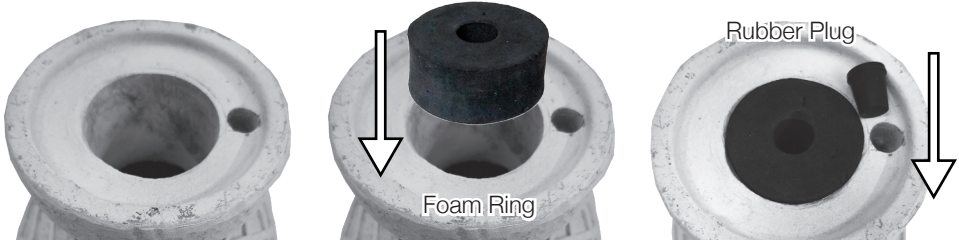

**Note:** If bowl is not filling with water ensure foam ring is properly seated.

**Step 1:** Install the Foam Ring and Rubber Plug into the bottom tight and snug.

**Step 2:** Place Planter Finial on Fountain. Make sure it's level.

**Step 3:** Once bowl is in place, push down on the foam ring from inside of the bowl to ensure a seal between the foam ring and the fountain.

## Bird Feeder Installation

To prepare as the Bird Feeder, turn over and remove the small rubber plug if already installed from the bottom of bowl.



**Step 1:** Turn over and if already installed pull out both the Rubber Plug and the Foam Ring.

**Step 2:** Turn over and place back onto the fountain.

**Step 3:** Place the Bird Feeder into the Bowl.



**Step 4:** Fill with bird seed.





# Planter Installation

To prepare as the Bowl as a Self-Watering Planter ensure that the smaller rubber plug is NOT installed. The small hole is where the planter gets water.



**Step 1:** Lift the Bird Feeder bowl out of the Planter Finial. Remove the Bird seed from the Bird Feeder bowl.



**Step 2:** Turn Planter Finial over. (Bottom side up.)



**Step 3:** If already installed remove Rubber Plug from Planter Finial.



**Step 4:** Turn Planter Finial over. (Top side up.)

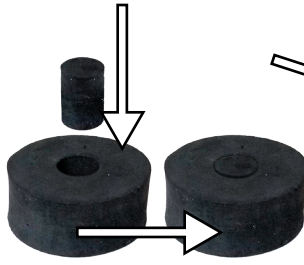

**Step 5:** Insert Foam Center Plug into the Foam Ring. This foam plug prevents over watering of planter.



**Step 6:** Insert Foam Ring into the large opening in the center of the planter. Ensure the top flat edge of Foam Ring (arrow) is flush with the top of the large opening in the center of the planter. This foam plug prevents over watering of planter.



**Step 7:** Fill Planter with your favorite soil.



**Step 8:** Plant your choice of plants. Lightly press soil around the center. Do not press too firmly otherwise the Foam Ring will descend down on top of the fountain pump outlet which will prevent water flow.



At this point, your Fountain should look like the image on the right. You are now finished installing the Planter, Bird Feeder/Vanishing Edge Bowl. Turn on your Fountain and enjoy!



# Troubleshooting and Maintenance

## Cleaning your Fountain

In order to keep your Fountain in tip-top shape and free of algae, you should clean your Fountain every two months. To clean your Fountain, drain of all water and disassemble. Use a mild soap and a soft cloth to clean the parts of your Bernini™ Fountain. Your Fountain Bowl will form a natural patina finish which with time may appear lighter or whiter than the original color. This is normal.

**DO NOT SCRUB YOUR FOUNTAIN, AS THIS COULD CAUSE DAMAGE TO THE FINISH OF YOUR BERNINI™ FOUNTAIN.**

## Cold Storage

Drain the water from fountain prior to the first freeze of the season. Clean and dry the fountain of all water. Remove the Rechargeable Battery and the Water Pump and bring it indoors. **Be sure to store the battery upright.** (Now is a great time to clean the pump to remove any debris that may have accumulated throughout the year) Store in a warm dry area. While your fountain is in storage it is recommended that the battery be charged once per month to ensure your battery will hold power for the following season.

## Recharging The Battery

If you connect your Battery to the charger before you plug into your outlet, the charger's light will glow a solid green to signify connection to the Battery. Once plugged into the outlet, the light will glow a solid red until charged. Then it will turn green.

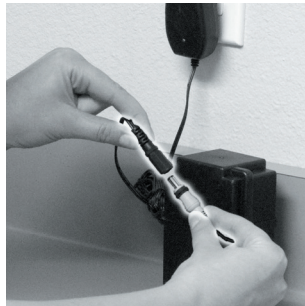
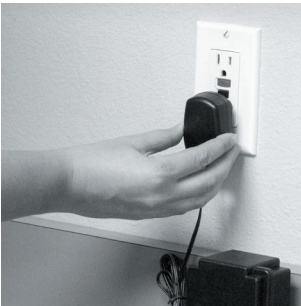

Begin by disconnecting the Battery from the Connection Port and remove from the Base of your Fountain.

**Step 1:** Plug the Battery Charger into an electrical wall outlet.

**Step 2:** Take the gray cord that is connected to your Battery and plug it into Battery Charger cord. While the Battery is charging, the light on the charger will be solid red.

**Step 3:** Charge the Battery for approximately 12-18 hours. When the Battery is reaching it's fully charged capacity, the light will blink for several minutes. Once the Battery Charger has turned green the Battery is done charging. Now you can detach the Battery from the charger and plug the Battery into your Fountain.

## IMPORTANT

**DO NOT CHARGE ON COUNTER TOPS, CARPETS OR OTHER FINISHED SURFACES. IT IS RECOMMENDED THAT THE BATTERY BE PLACED ON A CONCRETE SURFACE WHILE CHARGING.**

**NOTE: If the charger has not turned green after approximately 12-18 hours, charge for approximately 5 more hours.**



# Cleaning the Water Pump's Parts

## Water Pump Air Filters

After about six weeks of usage, you may want to clean the Water Pump's filter and impeller to keep your Bernini™ Fountain in tip-top shape.

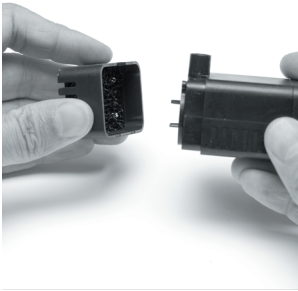

Begin by disconnecting the pump from the Fountain Tier.

**Step 1:** Remove the front of the Water Pump by grabbing the sides of the front panel and pull it off the unit.

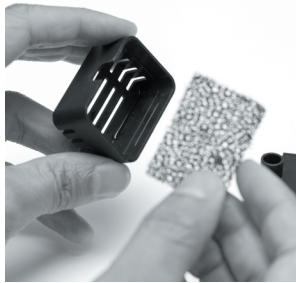

**Step 2:** Pull the water pump filter from the front panel.



**Step 3:** Wash the filters under running water until debris has been removed. Then replace the filters and pump's front cover.

## Water Pump Impeller

The impeller inside of the Water Pump is what pushes water up through your fountain, allowing you to enjoy the soothing sounds and wonderful sights of your Bernini™ Fountain. After long periods of usage, this part will need to be cleaned to make sure your fountain runs optimally.



**Please Note:** If pump is cavitating and or water is not flowing or not flowing properly, check that the water pump impeller chamber cover is pressed on all the way.

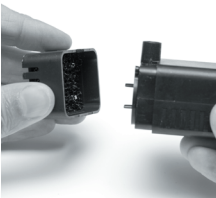

**Step 1:** Remove the front of the Water Pump by grabbing the sides of the front panel and pull it off the unit.



**Step 2:** Remove the impeller chamber cover. This is tightly fitted on to the impeller chamber, but will come off.



**Step 3:** Remove the impeller from its chamber.



**Step 4:** Rinse the impeller until all debris has been removed. Then replace the impeller in the impeller chamber, put the impeller chamber back on and then replace the pump's front panel.



# Is your fountain making a loud noise or do you not see water flowing?

## Try Priming the Water Pump

If you find the water pump is running, but water is not flowing from your fountain, or you hear a loud grinding noise coming from your fountain, not to worry, you can try priming the water pump:

Begin by turning your fountain off. Firmly grasp onto the two sides of the large bowl. Agitate the water by quickly shaking the fountain back and forth for about five seconds. Stabilize your fountain and press the C Button to turn your fountain On.



If the problem still persists, repeat previous step 2 - 3 times. This helps dislodge any air bubbles in your pump that may be causing the problem.

**If the problem still persists, try the method below:**

**Before beginning, remove any decorative tops from the fountain tier.**

Remove the fountain tier by turning the bowl a quarter turn counter clockwise and then lift. You can now rest the fountain tier on its side.

Now detach the water pump from the feeder tube inside the fountain tier.

**When removing the water pump, use caution when pulling the pump from the feeder tube. Pinch the bottom of the feeder tube close to the pump with one hand and then pull the water pump from the feeder tube with your other hand.**



**Step 1:** Submerge the Water Pump into the water inside the Large Bowl and lightly shake the pump underwater to release air bubbles inside the vents on the Water Pump.



**Step 2:** Turn the Fountain on and you should see water flowing from the pump. Let the pump run for about ten seconds and then turn your Fountain off.



**Step 3:** Reconnect the Water Pump to the feeder tube inside the fountain bowl and reattach the Fountain Tier to the Large Bowl.



## Using Leveling Shims

If you are having trouble getting water to flow evenly off of the spouts on your Bernini™ Fountain, you may need to level the surface that your Fountain was placed on. With the included leveling shims, you do not need to move your Fountain, just follow the instructions below to get even water flow.



Place the shim underneath the base on the opposite side that is not flowing as strongly as the other sides.



Once the fountain is flowing equally on all sides, then grasp the shim and break it on the crease closest to the end of the base.



Once the shim is broken, it will be hidden but will level your fountain.

## Weighing Down Your Fountain

**Do you happen to live in an area with strong winds? You can secure your fountain from possibly falling by using the weighted chamber inside the base.**

Note: Do not put sand on top of battery or connection port. Remove battery and connection port prior to adding sand.

Simply add several scoops of sand to the chamber in the bottom of the base. Even with sand added to the Base, the Battery can safely sit atop the platform in the middle of the Base's chamber.



# Water Pump Connection

If your Bernini™ Fountain did not come with the Water Pump already connected to the tube inside of the Fountain Bowl or if the Water Pump gets disconnected from the Fountain Tier, use these instructions to reconnect your Water Pump.



**Before beginning, remove any finials that may be installed in the fountain bowl.**

**Step 1:** Unlock the Fountain Tier by turning it a quarter turn counter clockwise.



**Step 2:** Rest the Fountain Tier on its side in the large bowl.



**Step 3:** Connect the male outlet on the top of the water pump to the tube inside of the Fountain Tier. Make sure this connection is snug.

Then reassemble the Fountain Tier with the instructions found in the Assembly Section of this manual.

## Troubleshooting Guide

PROBLEM	SOLUTION
<b>Fountain is not working</b>	Charge battery for recommended time (Refer to Recharging your Battery) battery has been charged and still will not hold a charge it may need to be replaced.
<b>Lights or Pump not working</b>	Check that battery is fully charged: See charging battery section.
	Make sure battery has been charged. Check that the connection port cables are secure.
<b>Water Not Flowing</b>	Prime Pump as instructed. (Refer to priming the water pump)
	Add Water
	Check to see that pump tubes are connected
	Check to see that the pump and pump tubes are clear of debris.
<b>Loud Pump</b>	Prime Pump as instructed. (Refer to priming the water pump).
	Check water level. Ensure pump free of debris.
<b>A/B/C/D Switch not working</b>	Make sure battery has been charged.
	Check that the connection port cables are secure. If secure disconnect battery and reconnect.
<b>Fountain Settings not working</b>	Make sure battery has been charged.
	Check that the connection port cables are secure. If secure disconnect battery and reconnect To clear settings.



# Troubleshooting Guide

PROBLEM	SOLUTION
<b>Water Not Flowing</b>	Check battery is installed correctly: See installing battery section.
	Check that battery is fully charged: See charging battery section.
	Pump is on but no water flow: Check water level.
	Pump is on but no water flow: Check pump is free of debris, kinks or obstructions. See Troubleshooting section.
	Pump is on but no water flow: Check water tube is connected properly. See Base and Fountain Ball Installation Section 1.
<b>Low Water Flow</b>	Check that battery is fully charged: See charging battery section.
	Pump is on but low water flow: Check pump is free of debris, kinks or obstructions. See Troubleshooting section.
	Pump has low water flow: Check water level.
	Pump is on but low water flow: pump is cavitating. See Priming The Water Pump Section.
<b>Loud Sound</b>	Loud sound and weak flow: Air in pump: See Priming The Water Pump Section.
	Loud sound and weak flow: Check pump is free of debris, kinks or obstructions. See Troubleshooting section.
<b>Suddenly Stops</b>	Pump suddenly stops: Check pump is free of debris, kinks or obstructions. See Troubleshooting section.

## LIMITED ONE YEAR WARRANTY

This product has a one year limited warranty on all materials and workmanship. Bernini™ warrants the original purchaser of this product that the product will be free from manufacturing defects in workmanship and material for a period of one (1) year from the date of original purchase. If within one (1) year this product fails due to defect in material or workmanship, Bernini™ will repair, replace or supply any defective part at their option. The purchaser must contact Bernini™ and provide a description of the defective part, including digital pictures if requested, with this original purchase documentation as validation of warranty coverage.

This warranty does not cover or apply to: (a) damage to the product due to misuse, mishandling, and abuse, (b) products not used in accordance with instructions, (c) product not assembled or installed according to instructions, and (d) normal wear and tear.

Call us for assistance at 1+ (619) 449-2392 or you can email us at:  
[customercare@berninifountains.com](mailto:customercare@berninifountains.com)  
 Our Customer Care Department is available:  
 Monday - Friday 8:30am to 4:00pm PST / 11:30am - 7:00pm EST



# IMPORTANT BATTERY SAFETY INSTRUCTIONS

**DANGER:** Do not store battery in an airtight container as it may cause an explosion.

**PROPOSITION 65 WARNING:** This product can expose you to chemicals including lead and lead compounds which are known to the State of California to cause cancer and birth defects or other reproductive harm. For more information go to [www. P65Warnings.ca.gov](http://www.P65Warnings.ca.gov).

**WARNING:** When using electric devices, basic safety precautions should always be followed to reduce the risk of fire, electric shock and personal injury, including the following:

## WARNING:

1. Do not incinerate the battery even if it is severely damaged or is completely worn out. The battery can explode in a fire. Check with municipal codes in your area for possible special disposal instructions.
2. If liquid leaks from the battery cell, discontinue use immediately and dispose of properly.
3. Do not charge battery in rain or in wet location.
4. Never attempt to open the battery for any reason. If the plastic housing of the battery breaks or cracks, immediately discontinue use and do not recharge. If the battery appears to be dusty or dirty, wipe it off with a soft cloth.
5. Use only the included battery.
6. Do not attempt to disassemble, remodel or destroy the battery, as it may cause battery leakage, fire, or bursting; and could also create sulfuric acid spills from the battery resulting in possible burns to person and damage to the immediate environment.
7. Exercise care in handling batteries in order not to short the battery with conducting materials such as rings, bracelets or keys. The battery or conductor may overheat and cause burns.
8. The battery contains diluted sulfuric acid, a very toxic substance. If the battery leaks and the liquid inside spills on the skin or clothing, immediately wash it off with plenty of clean water. If the liquid splashes into eyes, immediately flush the eyes with plenty of clean water and consult a doctor. Sulfuric acid in the eyes may cause loss of eyesight and acid on the skin will cause burns.
9. Charge battery using the specified charger and under the charging conditions as specified. Charging the battery under any other conditions may cause the battery to overheat, emit hydrogen gas, leak, ignite or burst.
10. When this product is not used for 30 days or more, remove the battery from the fountain, charge it fully and store in a place where humidity is low. Do not store the battery under direct sunlight or in high temperatures. Unsatisfactory storage conditions may cause deterioration in battery performance, and may shorten the service life.
11. When charging the battery always do so in a well ventilated area and where you can observe the charging process.
12. Never dispose of batteries in the garbage. Disposal of batteries in the garbage is unlawful under state and federal environmental laws and regulations. Always take used batteries to your local battery-recycling center.
13. **DO NOT CHARGE ON COUNTER TOPS, CARPETS OR OTHER FINISHED SURFACES. IT IS RECOMMENDED THAT THE BATTERY BE PLACED ON A CONCRETE OR SAFE SURFACE WHILE CHARGING.**

**B E R N I N I**<sup>TM</sup>  
F O U N T A I N S

---

Santee, California 92071

World Wide Patents Pending

Email: [customercare@berninifountains.com](mailto:customercare@berninifountains.com)

On the web: [www.berninifountains.com](http://www.berninifountains.com)

Facebook & Pinterest: Bernini Fountain Company

Instagram: @berninifountains Twitter: @yrdllc

© Yeiser Research & Development, LLC; 2019. All rights reserved.

---

Made in China  
Designed in the USA

001164 BAHF rev 4e us