

# **MIGHTY MITE REVERSE OSMOSIS SYSTEM INSTRUCTIONS**

- 1) Always use extra length tubing to make your connections, you may want to move the unit to replace the filters in the future.
- 2) Read the push-in fitting material on page 2, make sure you push the tube completely in.
- 3) If a fitting is not push-in, then use moderate pressure to snug up the fittings. Modern fittings do not rely on brute strength. They rely on teflon tape, o-rings or gaskets to make the seal ( just snug the fitting to make it secure ). Do not use glue. Plastic fittings that have been screwed on too tightly are subject to splitting. Stressed fittings may take days or even months to leak.
- 4) Please, Please, Please read this installation guide before installing the unit. This guide will answer a lot of your basic R.O. questions.
- 5) Ok! You installed it without reading the guide. Please read the guide before contacting us with questions or problems.
- 6) A 50 GPD system makes about 2 pure RO water gallons per hour, a slow trickle. Yes, more water goes to drain than is made. All RO systems make drain water while operating.
- 7) This systems max water pressure is 75 psi. Never connect a RO system to a water supply that has more than 75 psi or it could leak and cause property damage.

An in-line pressure gauge measures line pressure. Identify pressure drops that indicate the need to change filters.



If you have over 75 psi, you will need a PRV (pressure reducing valve - less than \$25)



If you have under 50 psi OR have a well pump, get our plug & play booster pump to optimize system performance.



## **REPLACEMENT FILTERS:**

**Mighty Mite Filter Pack**  
cost = around \$20



Replace this filter pack every 6-12 months or 1,500 total gallons (375 RO gallons)

**50 gallon per day (GPD) RO membrane**  
cost = around \$40



Replace your RO membrane every 1.5-5 years, when rejection rate is <90% or when RO production slows.

**Thanks,  
Chris, The H2O Guru**

*By the way... these are blue dust caps. Please remove & discard!*



## How to use Push In Fittings & How to remove Tubing

### Connecting:

**Cut the tube square.** It is essential that the outside diameter be free of score marks and that burrs and sharp edges be removed before inserting into fitting.

**Insert tube.** Fittings grips before it seals. Make sure the tube is pushed in all the way.

**Push up to tube stop.** Push the tube into the fitting, to the tube stop. The collet (gripper) has stainless steel teeth which hold the tube firmly in position while the 'O' ring provides a permanent leak proof seal.

**Pull to check secure.** Pull on the tube to check it is secure. It is a good practice to test the system prior to considering your handy work is done. The system doesn't full pressurize until the tank is full.

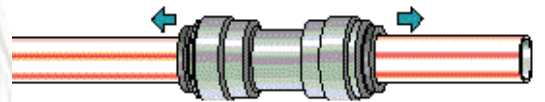
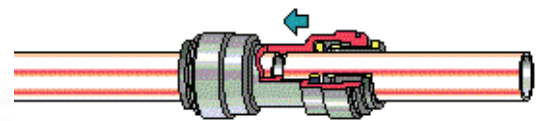
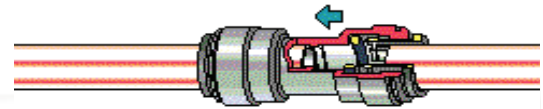
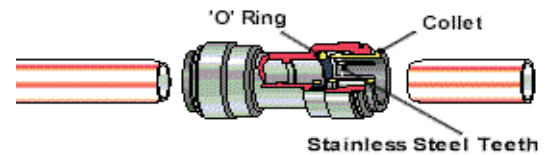

### Disconnecting:

**Push in Collet and remove tube.** To disconnect, ensure the system is depressurized before removing fitting. Push in collet squarely against face of fitting. With the Collet held in this position, the tube can be removed. The fitting can then be re-used.

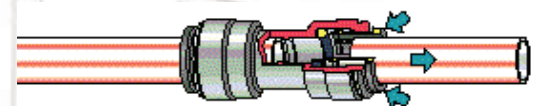

**Step 1: remove clip**



**Step 2: push in collet**



**Step 3: Remove & discard blue dust caps.**



# **MIGHTY MITE DIAGRAM**

*(please note the arrows on the filters point towards the directional flow of the water)*

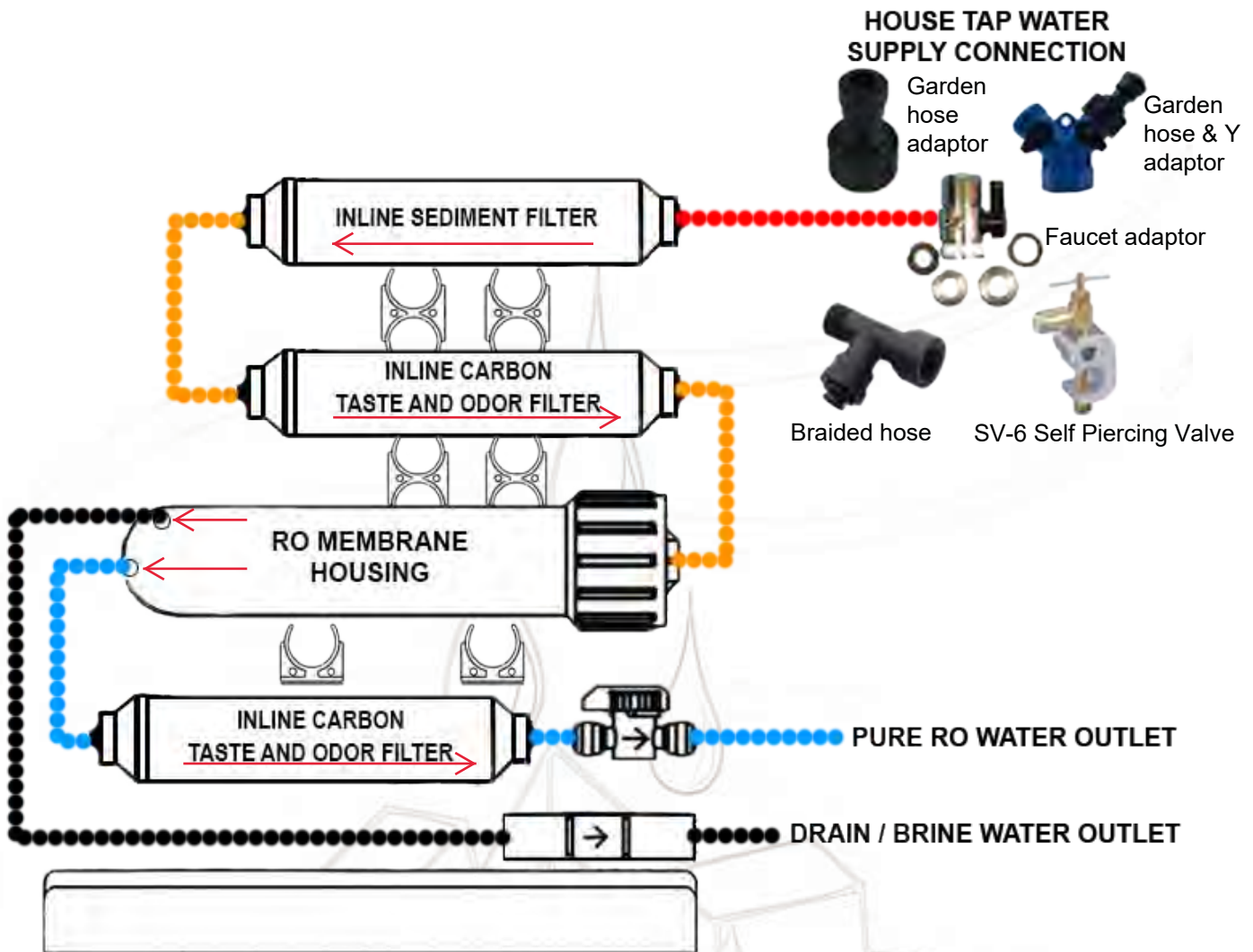

The picture above shows an example of a fully installed Mighty Mite RO System.

## **Preparing for Installation :**

Check out the area you will be working in. Is it safe? Any electrical around that should be turned off? Unplug all electrical cords in your area (garbage disposal etc). Do you have enough room? How about the lighting, will you be able to see what you are doing? Different areas have different requirements to meet local codes. We are presenting a generic method of installation. You will need to check out the local building codes to assure that your unit is installed in compliance with code.

## MIGHTY MITE ILLUSTRATION & INSTALLATION STEPS

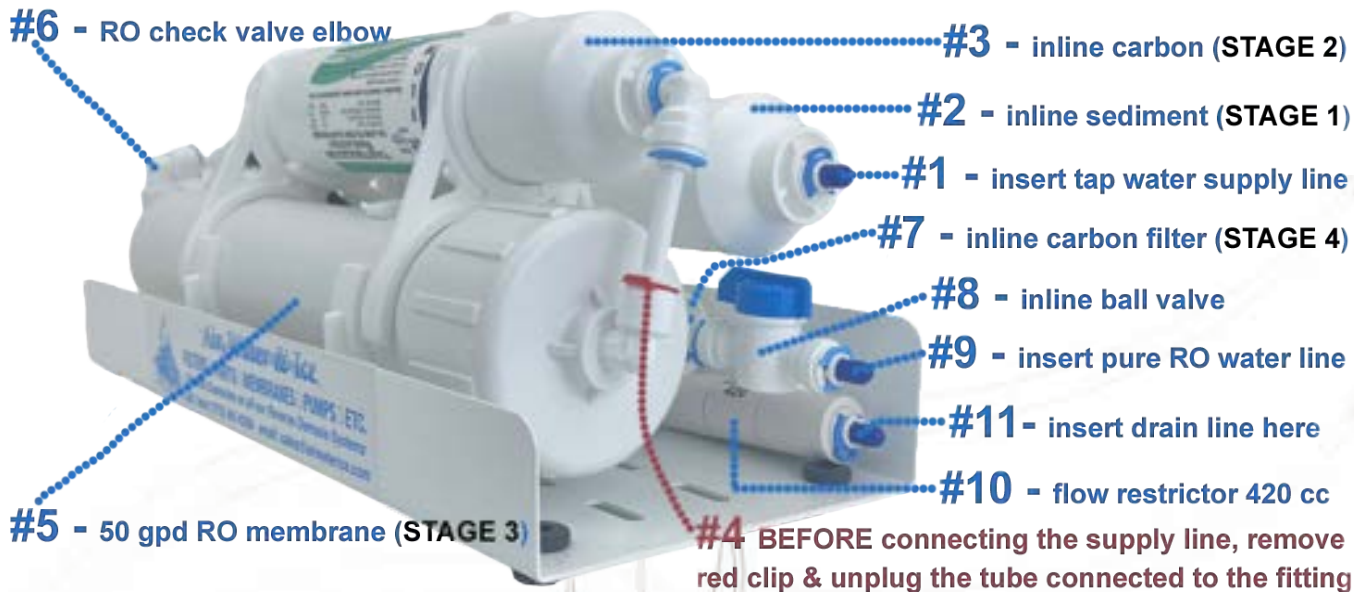

**STEP 1 ) Fast Flush Preparation.** DISCONNECT #4 red clip & remove this tubing. You need the first couple of minutes of water going through the system to come out of this tube #4 and not into your membrane #5 (this is how you will "fast flush" - see picture on to the right). "Carbon Dust/Fines" can potentially clog your system if this step is not performed. *We will fast flush in step 5 below. It is worthy to note here that we must always fast flush after changing filters.*

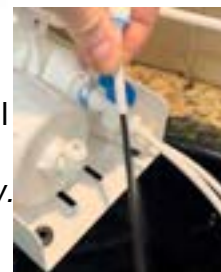

**STEP 2 ) Install Supply Line.** Connect your tap water supply connection (faucet adaptor, etc). Cut a piece of tubing long enough to go from your supply connection into the inline sediment filter #1.

**STEP 3 ) Install Drain Line.** The drain line goes from the flow restrictor #10 to your sink drain. Ideally, the drain line would be long enough to go at least 4 inches down the sink drain opening, but not into your drain line's P-trap. *Never place drain line into sink side with the garbage disposal.* Cut a piece of tubing long enough to go from your flow restrictor into your sink drain. Insert the tubing into the #11 connection and place tubing down into your drain.

**STEP 4 ) Install Pure RO Line.** Cut a small piece of tubing for your pure RO water line and insert your tubing into #9.

**STEP 5 ) Fast Flush** Turn ON your tap water supply connection. You should hear water going into the system & we will be "fast flushing" (exactly like the picture on above right). Water will be black (carbon dust) coming out of the #4 tube. Continue to flush until the water runs clear, about 5-10 minutes.

**STEP 6 )** Next, turn OFF your supply connection & reconnect the #4 tube & red clip.

**STEP 7)** Turn back ON on the tap water supply & open a pure RO water line (turn the in-line ball valve [#8 blue handle] parallel to the tubing aka "the open position").

**STEP 8 )** Discard the first full hour of pure RO water production. This allows the membrane preservation chemical to rinse completely out & clear the carbon dust/fines from the final taste & odor filter. Close the pure RO water valve & your tap water supply connection.

**STEP 9 )** Check for leaks ! Check again in a few minutes, after a half hour and after 3 days.

*Done! Enjoy your pure water on tap. Don't forget to change filters on time & make sure to sign up for filter change reminders on our homepage at [www.airwaterice.com](http://www.airwaterice.com)!*

## RO SYSTEM EVALUATION - perform 3 days AFTER installation:

### HOW LONG TO MAKE ONE GALLON TEST:

**Step 1:** Open a pure RO water outlet (either a RO faucet or a inline ball valve's blue handle). The picture on right shows a ball valve that is open----->



**Note1!** If you have a fast flush flow restrictor, ensure the black handle is in the closed / perpendicular // "normal operations position"---like this ----->



**Note2!** If you are using a pressure tank, ensure the tank ball valve is in the closed position (perpendicular to the tubing) like the picture on the right----->



**Step 2:** OK! Now we are all set up. Next, with a milk jug (or other one gallon container), time how long it takes to fill one gallon of pure RO water - remember - a 50 GPD (gallon per day) membrane should make ONE gallon in about 30 minutes. We are projecting our test here to the entire day - the more accurate you are with this test, the more accurate your result will be.

RECORD time to fill ONE gallon of pure RO water: \_\_\_\_\_

RECORD time to fill ONE gallon of drain water: \_\_\_\_\_

RECORD water temperature: \_\_\_\_\_ ;If your system is new or moved to a new location... you will want to RECORD time to fill ONE gallon from the tubing feeding your RO system tap water: \_\_\_\_\_

### HOW TO PERFORM A TDS TEST (easy!):

Worldwide, water quality is measured by TDS (total dissolved solids). This may sound daunting; however, we are confident that if you know how to use a ball point pen, you can master this in a couple of minutes. To perform a TDS test, you need simply a TDS meter. We sell these for less than \$20!----->>

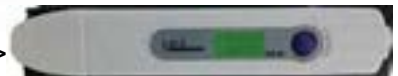

**Step 3 :** AFTER making one gallon of pure RO water, if you have a fast flush flow restrictor, perform a fast flush. To do this, leave your pure RO water outlet in the open position and turn the black handle to the right 90 degrees so it is parallel to the tubing. The picture on right shows a fast flush flow restrictor in "fast flush" mode----->>



During this time, we are removing tds creep, sending most of the water down the drain. After 5 minutes of fast flushing, return the fast flush's black handle to the "normal operations" position.

**Step 4 :** Next, let a few cups of water pour out of your pure RO water outlet.

**Step 5 :** While we are waiting for step 4, get a clean glass or container for your pure RO water sample (do not use the cap of the tds meter). Collect 6 oz. of pure RO water in this container.

**Step 6 :** To test your TDS, open the TDS meter's cap and place the tds meter in the center of your sample. Press the only button on the tds meter. Record the number that appears on the LCD screen below: (always test RO water, then tap water & then drain water)

RECORD RO water quality (A): \_\_\_\_\_

RECORD TAP water quality (B): \_\_\_\_\_

RECORD DRAIN water quality (C): \_\_\_\_\_

RECORD YOUR MEMBRANES REJECTION RATE: \_\_\_\_\_

(to find your membranes rejection rate, use a calculator and take: ["A" divided by "B" minus 1])

- Average TDS in US homes: = 250 ppm (parts per million) TDS (total dissolved solids)
- TDS level considered excellent for drinking water:= < 50 ppm TDS.
- Minimum acceptable rejection rate before it's time to replace your membrane: = 90%
- Average RO water quality for our customers who change filters on time = < 10 ppm TDS.

## Water Terminology & FAQ

**Pressure Reducing Valve (PRV)** This valve is installed when your house pressure is above 70 psi. This valve reduces your line pressure to 70 psi. (Your RO membrane only needs 50-60 psi to operate as designed, so a PRV is an easy plug & play solution to high water pressure that causes continuous drain water & other issues.

**Automatic Shut Off Valve ((ASOV)** the ASOV is what shuts your system off & prevents your system from making continuous drain water. When the pure water line reaches 2/3 of your incoming water supply pressure, the ASOV will activate and close the prefilter line, preventing water from going into the membrane and the drain.

**Fast Flushing** Fast flushing is an important maintenance step for your system as it washes the stale water out of your system. For drinking water RO systems, we recommend fast flushing for 5-15 minutes at least once every 2 weeks. For systems with a DI stage, we additionally recommend fast flushing a couple of minutes before & after you make a batch of RODI water as this preserves the life of your membrane & deionization resin.

**System Purge** Not to be confused with fast flushing above - a system purge is when we run the system for 15 minutes without any filters OR membrane to clean and remove potential clogs. Be sure to flip the black fast flush handle several times during this step and tap the ASOV and/or permeate pump a few times with your hand. This method is the fastest way to resolve clogs on new systems & after filter changes. Although it is rare for a any system to need a purge, needing to perform this step on a new system or location may indicate that you have low house pressure (less than 50 psi) or low flow (less than 1.5 GPM) going into your RO system.

**Booster Pump** IF you have lower than 50 psi on your water supply line feeding your RODI system water, we advise getting a booster pump. The pump we have sold for 35+ years is very reliable & above else the quietest plug & play pump we have tested. Although our powerstation booster pump is designed for well water applications with 40/60 cut in/out well pump switch's, this pump works great for city water & several other applications - please contact us for applicability if you are not certain at 772-461-0256.

**Depressurizing the System** To change filters, membranes, remove tubing or open housings we must relieve the pressure in the system. Turn off your water supply going into the system & open a pure RO valve. After a few minutes the system will be depressurized & the tubing & housings will be able to open.

**System Life Expectancy** We recommend replacing your entire system after 7 years of use. Contact us to receive our best deal. Typically our discount for a system repurchase is less than \$100 difference than if you were to purchase a new membrane and filter pack.

**System Environment** Your system cannot be exposed to freezing temperatures, hot water, fire or higher than 75 psi water pressure. IF your system was exposed to any of these, you must replace the entire system. IF your system is exposed to direct sunlight, bacteria growth should be expected, filter life & water quality will be less.

**TDS Test:** A TDS meter quickly & accurately lets you know when to change your DI resin & your membrane.

### Troubleshooting FAQ's - (please see our online FAQ guide at [www.airwaterice.com/pages/faq](http://www.airwaterice.com/pages/faq) for more!)

**FAQ#1: The vertical DI housing has air trapped inside. Is this normal?** It's nothing to worry about. Water is part air (h<sub>2</sub>o). Normally the cartridge will fill 1/4 of the way full with water when pure RODI water is being made.

**FAQ#2: Slow or No pure RO water?** RO systems make water at a rate of 2-6 gallons per hour, a slow trickle. If this happened all of the sudden or after changing filters, make sure your fast flush is closed, (black handle perpendicular to the tubing). New systems or new locations for old systems with low water production typically have something to do with either the house pressure being low or less than ideal supply connection. If this has happened over time, it's likely time to replace your filters and/or membrane or if you have a drinking water system with a FULL pressure tank, it is time to recharge the pressure tank.

**FAQ#3: No drain water?** All RO & RODI systems send water to the drain while operating. If you cannot hear water going down the drain, unplug the drain line & check. Your system will not last very long if no drain water is being made. Disconnect the fast flush flow restrictor from the system. Look through the fast flush into a light. Do you see a small pinhole from both positions (open/closed)? If you do not, it is clogged. Use your water supply line or a air compressor to blow out the debris. This method will also work for a clogged permeate pump. IF this still does not allow drain water to pass, perform a system purge, then a RO system evaluation and contact us.

**FAQ#4: Continuous drain water.** Please ensure your fast flush flow restrictor's black handle is pointed up, at a right angle, perpendicular to the tubing like this!----->



Note! For rodi systems with DI bypasses installed, please also ensure the blue ball valve's handles to the left of the flow restrictor are in the closed position like this!----->



\*\*\*If you still have drain water after ensuring correct positions above: perform a Fast flush.

If your system still makes drain water, you will need to perform a System Purge & RO System Evaluation found in your systems instructions & contact us with the results. If you

don't change your filters or membrane on time, continuous drain water is likely. Having low (below 40 psi) or high (above 75 psi) house pressure will also cause your system to have continuous drain water.

## CHANGING FILTERS GUIDE:

### Caution!

- Do not attempt to open a filter that is under pressure.
- Have a sponge and perhaps a small pail handy. You will spill some water.
- Turn off / unplug any close electrical systems.
- The floor might become wet and slippery.

**Note!** This is a general guide. Have the instruction manual for your specific system handy. Your systems manual will go into detail about your systems specific features, valve positions and more!

### The Basic Filter Changing Process: (at least every 6 - 12 months)

**step 1:** Turn off the water supply going into the RO / RODI system

**step 2:** Open a pure RO or RODI water outlet ( ro faucet, ball valve OR di bypass) to relieve the water pressure

**step 3:** Change the filters

- 3.1 Unscrew the filter housings & remove the old filters and/or membrane (use the housing wrench).
- 3.2 Clean the housings with soap & water and rinse thoroughly.
- 3.3 Change the filters. **Note1)** When re-attaching the housings, NEVER use the housing wrench to tighten the housings. **Note 2)** Ensure the housing's O-rings are in place and properly seated before attempting to re-attach the housings. **Note 3)** For in-line filters, please note the arrow on the filters indicating the directional flow of water. **Note 4)** All In-line filters have blue dust caps, please remove & discard these in the same way tubing is removed... press in on the collet with your finger or wrench & pull tubing in the opposite direction (see pic)----->



**step 4:** Fast flush the system



- 4.1 Turn your fast flush flow restrictor's black handle parallel to the tubing- see picture above.
- 4.2 Next, open a pure RO water line (i.e. RO faucet, inline ball valve, etc). Now you are fast flushing!
- 4.3 Fast flush your system for 15 minutes.
- 4.4 After fast flushing, please ensure you return the flow restrictor's black handle back to the closed (normal operations) position (black handle pointed up - perpendicular to the tubing).

**step 5:** If you are replacing your membrane, discard the first hour of RO water the system makes.



**IMPORTANT!** Fast flushing sends almost all of the carbon dust/"fines" out of the system & directly into the drain as opposed to potentially clogging your system. Fast flushing is great way to keep your membrane clean & extend the life of your di resin. **Note!** Always fast flush immediately after installing new filters. If you have dramatically reduced pure RO water, little or no drain water, or constant drain water **AFTER** installing new filters and/or membrane, the following 3 items are the most common reasons why. IF these 3 items don't solve your problem, perform a system purge (see below).

Is your **fast flush in the closed position** ?

Is your **pressure tank pressurized**\*\*\* ?

IF you have a **DI bypass, is it closed**?



**How to PURGE:** Step 1: Remove all of your filters & remove the membrane. Step 2: Screw the filter housings & membrane housings  back on the system without the filters or membrane. Step 3: Open a RO water line with the fast flush in the closed/normal operations mode for 30 minutes without any filters or membrane. During this step, turn the fast flush's black handle back & forth multiple times & tap the automatic shut off valve (ASOV)  and/ or the permeate pump  with your hand. Purging clears potential clogs 99% of the time. If this does not work, remove the fast flush flow restrictor. Hold the fast flush up to a light. You should see a large hole when the fast flush is open AND a small hole when the fast flush is closed. If you do not see light through the fast flush in both positions, your fast flush is clogged. To clear the clog: blow through, use a air compressor or your water supply line... this method also works for permeate pumps that get clogged.



\*\*\*To recharge your pressure tank, inflate schrader valve to 7-9 psi with the tank empty & ball valve open.

## When to change the filters?

The drain water made should be included in your calculation of when to change your filters. Drain water is the lifeblood of your system & essential for pure RO water. We plumb most of our RO systems to get a 3:1 waste to pure water ratio. This means for a filter rated for a 3,000 gallon life, it will be exhausted after we make 750 pure RO gallons as we have sent 2,250 gallons down the drain. Change filters when pure RO water production slows, if a filter look visually dirty, if the filter has reached the end of its filter life rating OR at least every year, whichever comes FIRST. If you have well water or otherwise hard water to begin with, you will need to change filters more often. Please note the membrane is always sold separately from our filter packs.



**Sediment Filters:** (Stage 1) (*pre-filter*) [ life= 3,000 total gallons or 1 year for full 10" sediment filters or 1,500 gallons or 1 year for inline sediment filters  ]. The sediment filter traps dirt & will become clogged. Sediment filters protect carbon filters from getting clogged.



**Carbon Filters:** (Stage 2-3) (*pre-filter*) [ life= 3,000 total gallons or 1 year for full 10" carbon filters or 1,500 gallons or 1 year for inline carbon filters  ]. Carbon filters remove chlorine, chemicals, taste & odor. The carbon block is vital & required to be changed on time to protect your membrane from exposure to chlorine. Changing carbon filters on time extends the life of your membrane. Among other things, carbon filters protect your membrane from chlorine & chloramines.



**Reverse Osmosis (RO) Membrane:** (Stage 3-4) (*the filter*) [life= 6,000 - 15,000 total gallons, 1.5 - 5 years, or when rejection rate drops below 90%. Membranes are normally changed because of slow or no production. The other reason to replace the membrane is production of excessive amounts of poor quality water. Chlorine exposure, inadequate carbon filter replacements or low pressure are usually to blame for a membranes reduced life. Many water chemistry matters go into membrane life expectancy & we cannot accurately predict how your membrane will do. What you must know is when your carbon blocks are exhausted, they allow chlorine to pass through to the membrane. A process called oxidation begins. This initially causes a reduction in pure RO water. Next, your membrane sheets break, putting holes in your membrane & you will have a large amount of poor quality water. When new, RO membranes reject 95-99% of TDS. Over the next 2-5 years, this rejection rate will decrease. You will need a TDS meter to easily perform a TDS test\*\*\* to find your membranes rejection rate. Temperature and water pressure play a role in your membranes production. Please see 2 charts below!

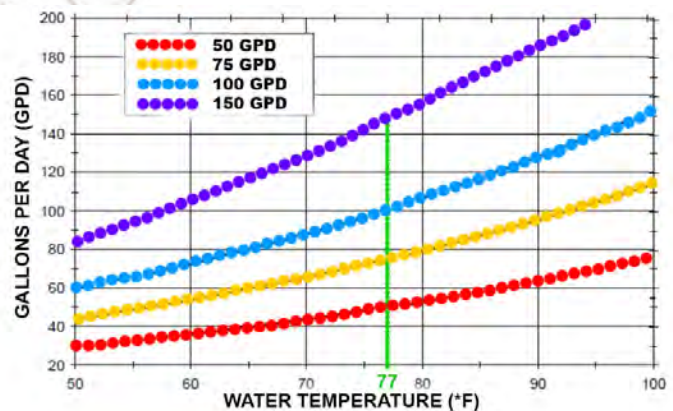
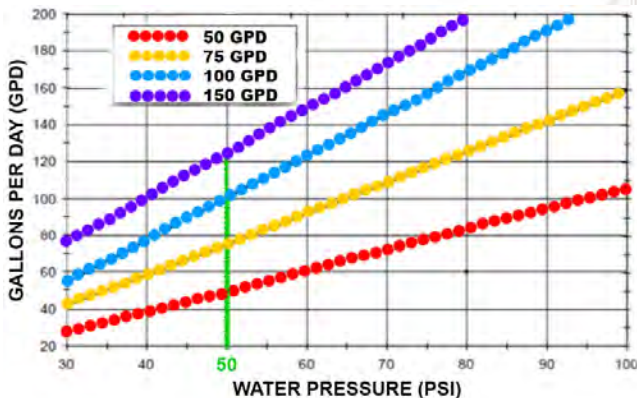

**Deionization (DI) Resin Filters:** (Stage 4-8) (*post-filter*) [ life= minimum 3,000 ppm TDS capacity for our full 10" DI cartridges or [1500 ppm TDS capacity] for our inline di filters. Resin may smell "fishy" when exhausted. The color changing feature of our di resin goes from green or blue to a golden brown color and is a INDICATOR that the resin is exhausted. We recommend performing a TDS test when color changes. A rough mathematical equation of resin filter life: If your RO tds is 10 ppm, take  $3,000/10 = 300$  gallons of zero tds water before the resin is exhausted & needs replacement.

**Ultra Violet (UV):** (*post-filter*) [ life= 1 year] UV lights will make a humming noise when in need of replacement. Another way to check is temperature, a working light produces a warm housing.

**Mineral Filters (calcium and magnesium)** (*post-filter*) [ life= 1,000 gallons or 1 year]

\*\*\*How to perform a tds test? ALWAYS make one gallon of pure RO water before a TDS test to avoid testing the stale "tds creep" water in your system. Get a clean glass. Pour about 6 oz of pure RO water in the glass. Put your TDS meter in the glass & press the button on the TDS meter. Record the number. Pour out the glass and then test your TAP water, & then test your DRAIN water. Don't use the cap of the TDS meter - again, you want to sample about 6 oz of water! As always, we are committed to your success. Please contact us with any questions!

Questions? Call or text : 772-461-0256 / email : sales@airwaterice.com or visit us online at [www.AirWaterIce.com](http://www.AirWaterIce.com)