



OXFORD OTTOMAN INSTALLATION VIDEO

Scan the QR code on this page which will take you to the video or type the URL below into your browser. Please note the URL link is case sensitive.



SCAN ME



Need any assistance in assembling your bed?
Simply drop us an email or call us on our landline for support with assembly.

email: hello@furnitureful.com
phone: 0121 820 7713



IMPORTANT INFORMATION

ADVICE

- Please ensure that the bed is fully assembled and secured before it is used
- Please check the pack contents before assembling the bed, if any components are missing please contact Furnitureful customer services with the provided contact information.
- Due to the size, it is recommended that items are assembled on a flat surface. This product should only be used on firm and level ground
- Please do not use any tools other than the ones provided and shown in the assembly guide
- Do not discard any of the packaging or the instructions. Check you have all the parts and fittings and keep out of the reach of children
- The packaging will be needed if the bed has to be returned



INITIAL USE

Position the mattress on the slat frame while it is in the closed position. Operate the belt handle to open and close the bed.

PLEASE NOTE - When lowering the slat frame for the first time, take care to make sure it does not rub unevenly on the inside face of the side rails. If it does, the bed has been assembled slightly out of square. This can be reflected by moving the foot end of the bed slightly to the left or right whilst leaving the head end stationary.

PISTONS

The gas pistons for this bed are extremely strong and cannot be operated by hand when not fitted to the Ottoman bed. All pistons are tested for correct pressure and operation before being distributed with the bed.







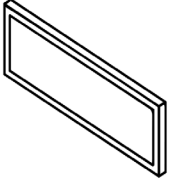
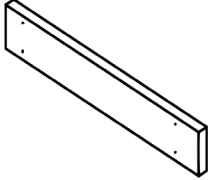
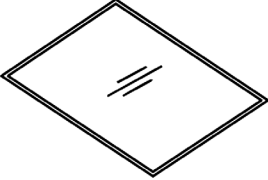
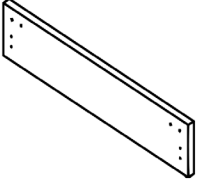
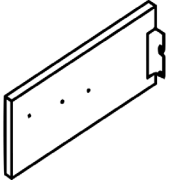
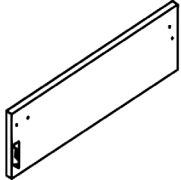
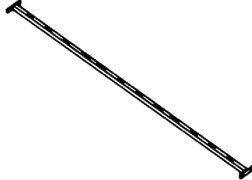

Initially it might appear that the pistons are very stiff when opening and closing the Ottoman bed - THIS IS PERFECTLY NORMAL. After operating the Ottoman bed a few times, the pistons for opening and closing the storage area will become easier.

WARNING

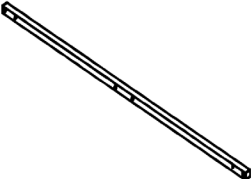
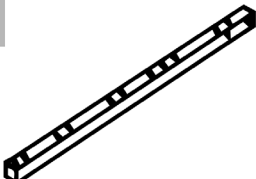
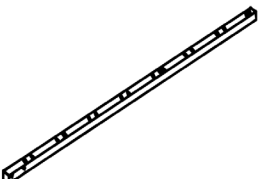
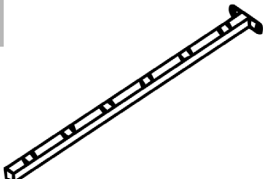
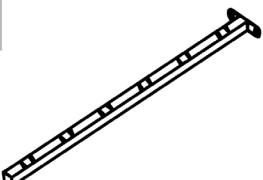
For the safety of yourselves and others, please ensure that:

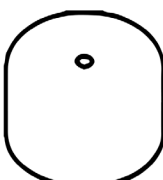
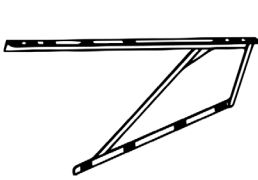
- Children do not play in the storage area, the gas pistons or try and lift the metal frame
- Please do not stand in the storage space at any time
- Ensure that hands and fingers are clear of the mechanism when opening or closing the bed
- Please do not stand on the wooden slats, or any part of the bed
- Only use the storage compartment when the frame is fully raised and in the correct position
- Please do not over tighten, screws, nuts or bolts on the bed frame
- Do not use scourers or chemical cleaners. To wipe clean, please use a sponge and warm soapy water.
- Do not use solvent based cleaners or detergents as they can bleach or damage the bed
- Only use the belt when lifting and lowering the frame. Failure to comply with this warning may result in injury and finger entrapment.
- Attach the belt to the metal part of the frame and make sure it is always visible on the outside of the bed frame.
- Ensure the metal frame is fully raised in the 'Up' position before using the Ottoman space, otherwise the frame could fall causing injury.
- Do not attempt to move the bed while the frame is in the 'Up' position
- Please keep children and pets away from the Ottoman bed while opening and closing the slat frame to avoid any possible injuries

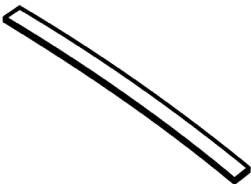
COMPONENTS: PARTS

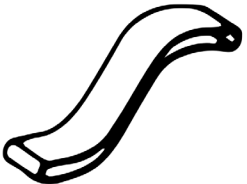
1		2		3		4	
	1x Headboard pt1		1x Headboard pt2		1x Fabric Base Sheet		1x Footboard
5		6		7		8	
	2x Headboard Sided Panels		2x Footboard Sided Panels		1x Connecting Metal Bar		2x Headboard Connectors
9		10		11		12	
	2x Metal Frame Rail		2x Metal Frame Rail Short		2x Metal Frame Rail Long		1x Metal Frame Rail Short
13		14		15		16	
	1x Metal Frame Rail Long		2x Metal Legs		4x Plastic Feet		2x Lifting Mechanisms
17		18		19		20	
	2x Pistons		22-24x Wooden Slats*		1x Metal Bracket		1x Belt

*DISCLAIMER:









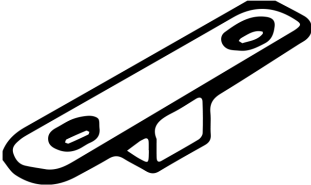
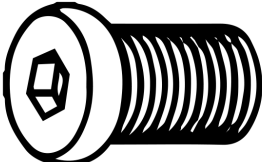
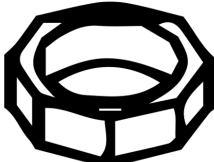
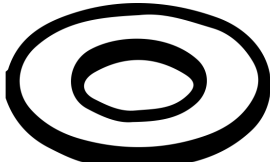

Depending on the size of your bed the number of parts for the Slats, Centre Slat Caps & Side Slat Caps may vary.

Centre Slat Caps: King - 12x, Double - 11x, Small Double - 11x, Single - 11x

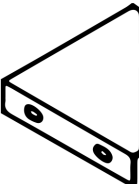
Side Slat Caps: King - 24x, Double - 22x, Small Double - 22x, Single - 22x

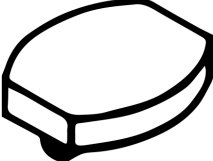
Slats: King - 24x, Double - 22x, Small Double - 22x, Single - 22x

COMPONENTS: FITTING

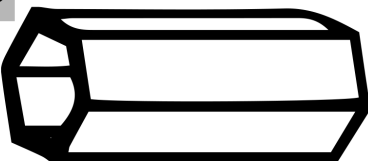
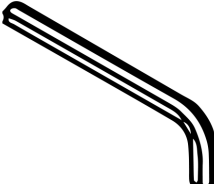
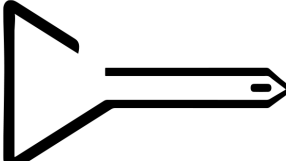
<p>21</p>  <p>4x M4*40 Screws</p>	<p>22</p>  <p>4x M8*30 Bolts</p>	<p>23</p>  <p>2x Metal Connecting Plates</p>
<p>24</p>  <p>32x M8*20 Bolts</p>	<p>25</p>  <p>32x M8 Nuts</p>	<p>26</p>  <p>44x M8 Washers</p>
<p>27</p>  <p>36x M8*40 Bolts</p>	<p>28</p>  <p>2x Corner Plates</p>	<p>29</p>  <p>4x Corner Connectors</p>
<p>30</p>  <p>11-12x Centre Slat Caps*</p>	<p>31</p>  <p>22-24x Side Slat Caps*</p>	<p>32</p>  <p>4x Corner Frame Joints</p>
<p>33</p>  <p>2x Side Plates</p>	<p>34</p>  <p>4x 3.5*12 Screws</p>	<p>TOOLS</p>
<p>35</p>  <p>1x Tightening Bolt</p>	<p>36</p>  <p>1x Allen Key</p>	<p>37</p>  <p>1x Cross-head Screwdriver</p>

ASSEMBLY GUIDE

STEP 1

WHAT YOU NEED:

- 2x M4*40 Screws
- 2x Plastic Feet
- 8x M8 Washers
- 4x M8*40 Bolts
- 4x M8*30 Bolts
- 2x Headboard Connectors

INSTRUCTIONS

- A. Screw on the plastic feet to the Headboard pt2 as show in illustration using M4*40 Screws, ensure that they are on the end nearest the Velcro strip.
- B. Align the Headboard Connectors with the pre-made holes on the grey upholstered side of the Headboard pt2 and secure in place with M8*40 Bolts and M8 Washers
- C. Connect and align Headboard pt1 to the Headboard Connectors and secure in place with M8*30 Bolts. There are pre-made holes on Headboard pt1's back.

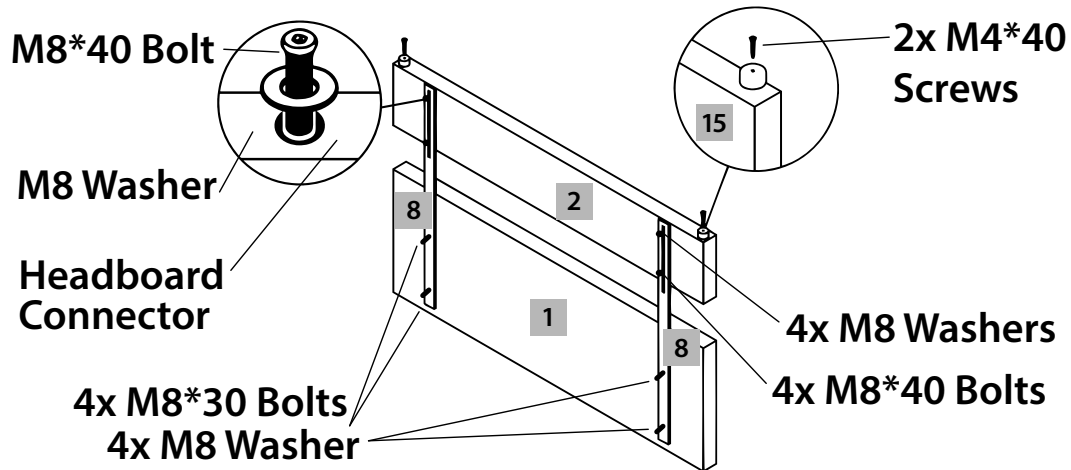

STEP 2

WHAT YOU NEED:

- 2x Plastic Feet
- 4x M8*20 Bolts
- 2x M4*25 Screws
- Cross-head Screwdriver

INSTRUCTIONS

- A. Attach plastic feet to the footboard using M4*25 screws.
- B. Screw in M8*20 Bolts to the inside of the footboard as seen in illustration..

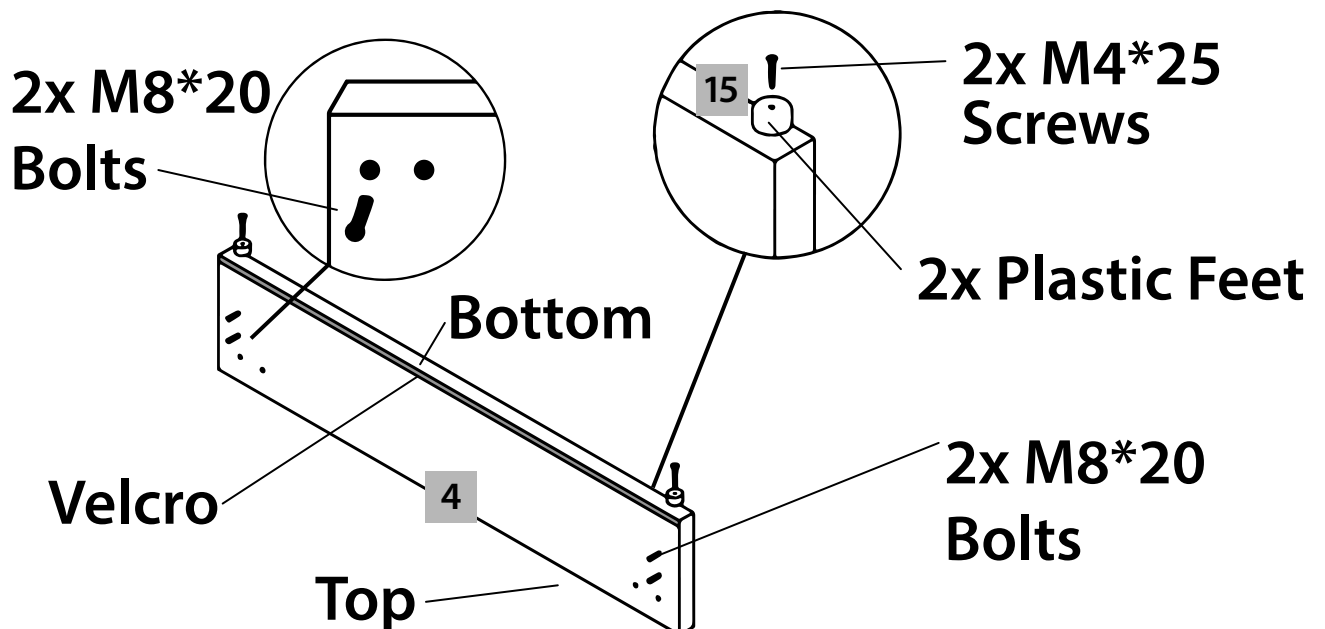

STEP 3

WHAT YOU NEED:

- 2x Headboard Sided Boards
- 2x Footboard Sided Boards
- 4x M8*20 Bolts
- 4x M8 Washers
- 2x Metal Connecting Plates
- 1x Allen Key
- 2x Side Plates
- 4x 3.5*12 Screws

INSTRUCTIONS

- Connect the side boards using metal connecting plate and fixing in place using M8*20 Bolts and M8 Washers.
 - Using the 3.5*12 Screws, secure the side boards with the side plate.
- TIP:** Do this upholstered side down to prevent scratches on your floor
- Repeat process to assemble both side boards.

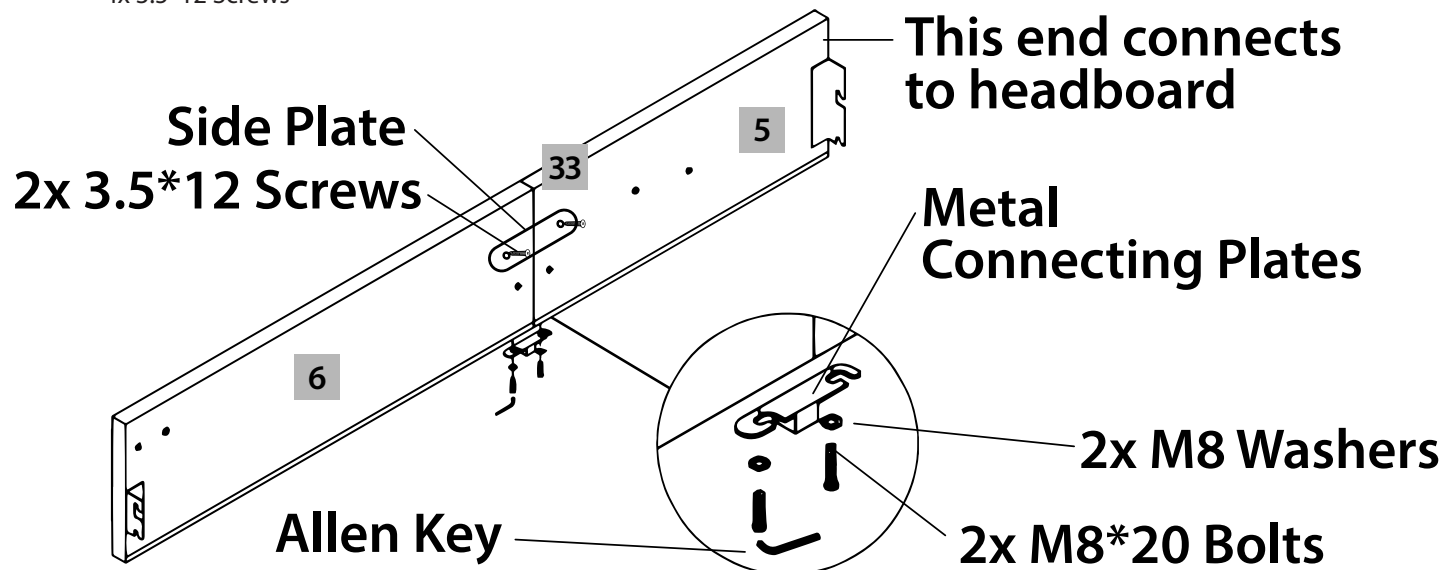

STEP 4

WHAT YOU NEED:

- 2x Lift Mechanisms
- 8x M8*20 Bolts
- 1x Allen key

INSTRUCTIONS

- Attach the lift mechanisms to assembled side boards.
- Repeat process on the other side on the assembled side boards.

Use this diagram to ensure mechanisms are positioned the correct way

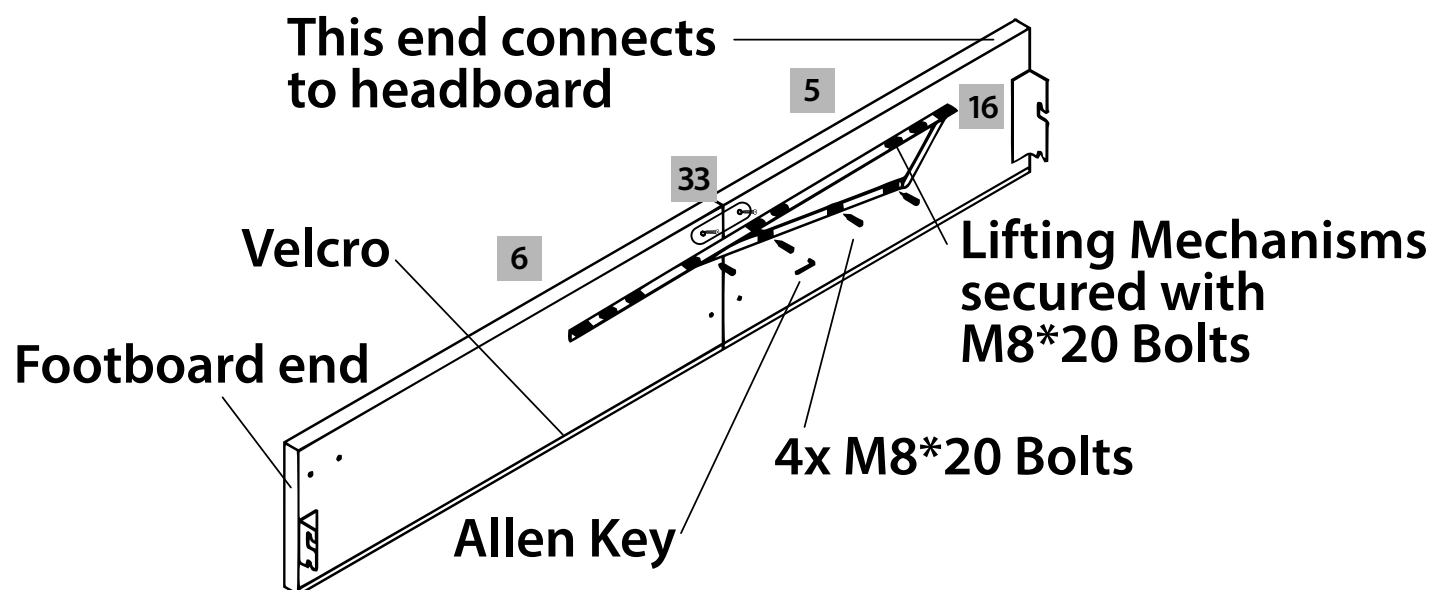

STEP 5

WHAT YOU NEED:

- 1x Allen key
- 20x M8*40 Bolts
- 20x M8 Washers
- 20x M8 Nuts
- 1x Tightening Bolt
- 4x Corner Connectors
- 2x (9) Rails
- 2x (10) Short Rails
- 2x (11) Long Rails
- 1x (12) Short Rail
- 1x (13) Long Rail
- 4x Frame Corner Joints

INSTRUCTIONS

- Use the Frame Corner Joints to connect the outside of the frame made up of (9) Headboard Rail connected to (10) short Rails, for the headboard end. The (9) Footboard Rail connected to (11) long Rails, for the footboard end.
- Connect (12) short & (13) long Rails to the middle of the (9) Rails using M8*40 Bolts, M8 Nuts & M8 Washers. Ensure that the short rails are on headboard side and the long rails footboard side.
- Place the corner connectors in 4 corners, secure & tighten using M8*40 Bolts, M8 Nuts & M8 Washers.

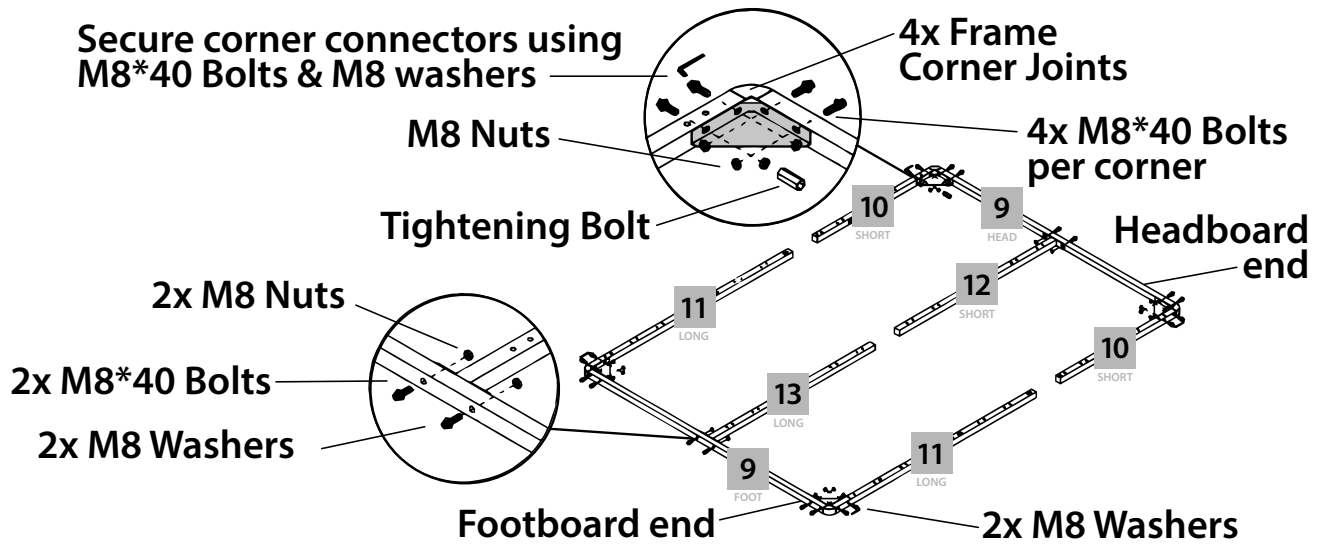

STEP 6

WHAT YOU NEED:

- 2x Assembled Side Boards
- 1x Headboard
- 1x Footboard
- 2x Corner Plates
- 8x M8*20 Bolts
- 1x Fabric Base Sheet
- 1x Allen Key

INSTRUCTIONS

- Connect the assembled side panel with headboard and footboard. Side panels have metal hooks that need to be slotted in the inserts on footboard and headboard. Ensure that all side facing inwards have the Velcro strip at the bottom of the panel.
- The Bolts go into each panel with the side hooks clipping together onto the bolts. Once panels have been clipped together, tighten the bolts to secure the panels in place.
- Secure sideboards with Footboard using Corner Plates and M8*20 Bolts, tightening with Allen key. Repeat on the other side.
- Attach fabric sheet to the base using the Velcro strip.

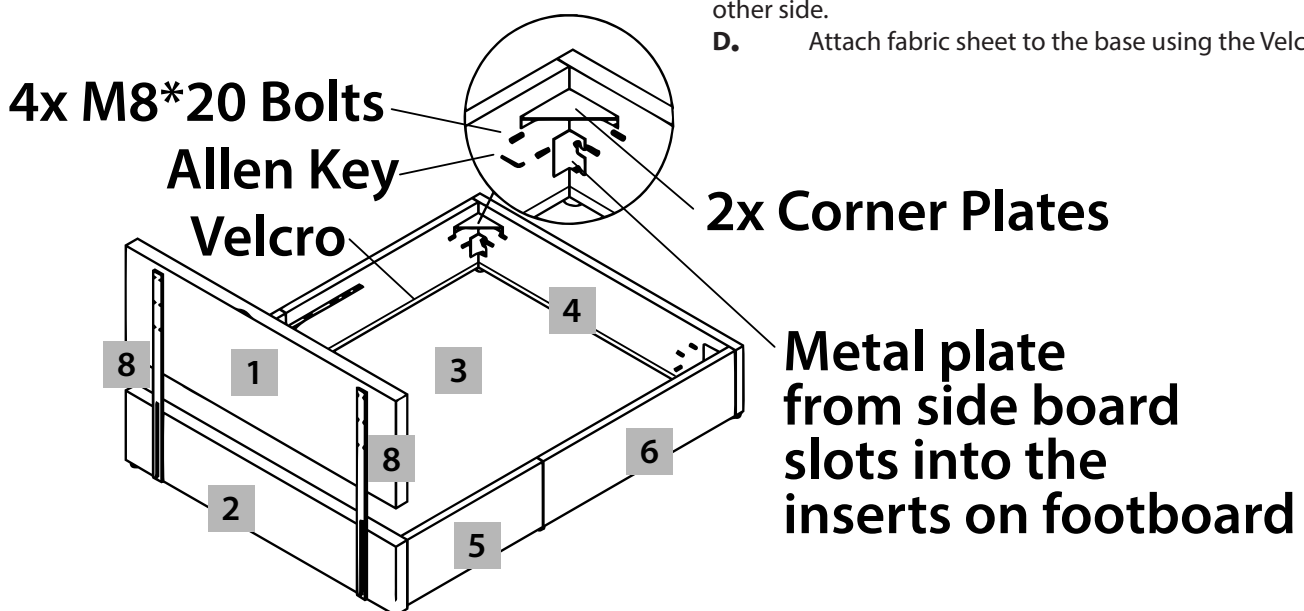

STEP 7

WHAT YOU NEED:

- 1x Connecting Metal Bar
- 4x M8*20 Bolts
- 4x M8 Washers
- 1x Allen Key

INSTRUCTIONS

- Position Connecting Metal Bar over holes under Lift Mechanism.
- Attach the connecting metal bar to sideboards using M8*20 Bolts and M8 Washers.
- Tighten with Allen Key and repeat process on the other side

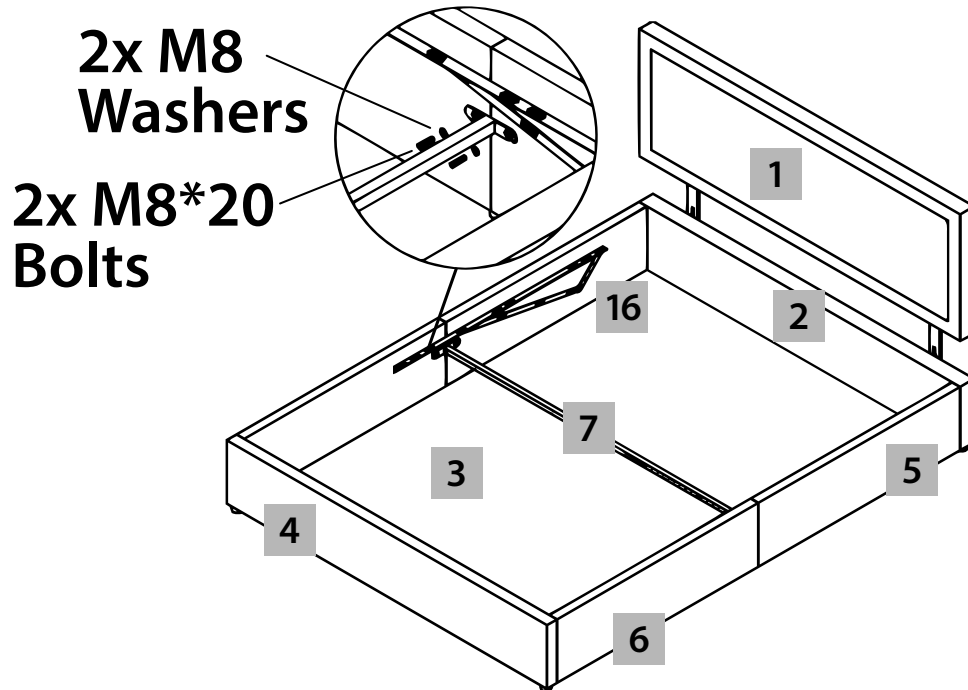

STEP 8

WHAT YOU NEED:

- 1x Allen key
- 1x Tightening Bolt
- 12x M8*40 Bolts
- 12x M8 Nuts
- 12x M8 Washers
- 2x Metal Legs
- 1x Tightening Bolt
- 1x Metal Bracket

INSTRUCTIONS

- Place the metal frame onto the lifting mechanisms.
- Using M8*40 Bolts and M8 Nuts, secure the metal frame on top of the lifting mechanisms as shown in diagram.
- Repeat process on the other side.
- Using the M8*40 Bolts and M8 Washers secure the two metal legs onto the middle metal bar of the frame as in image.
- Attach Metal Bracket to the middle of the headboard end of the metal frame

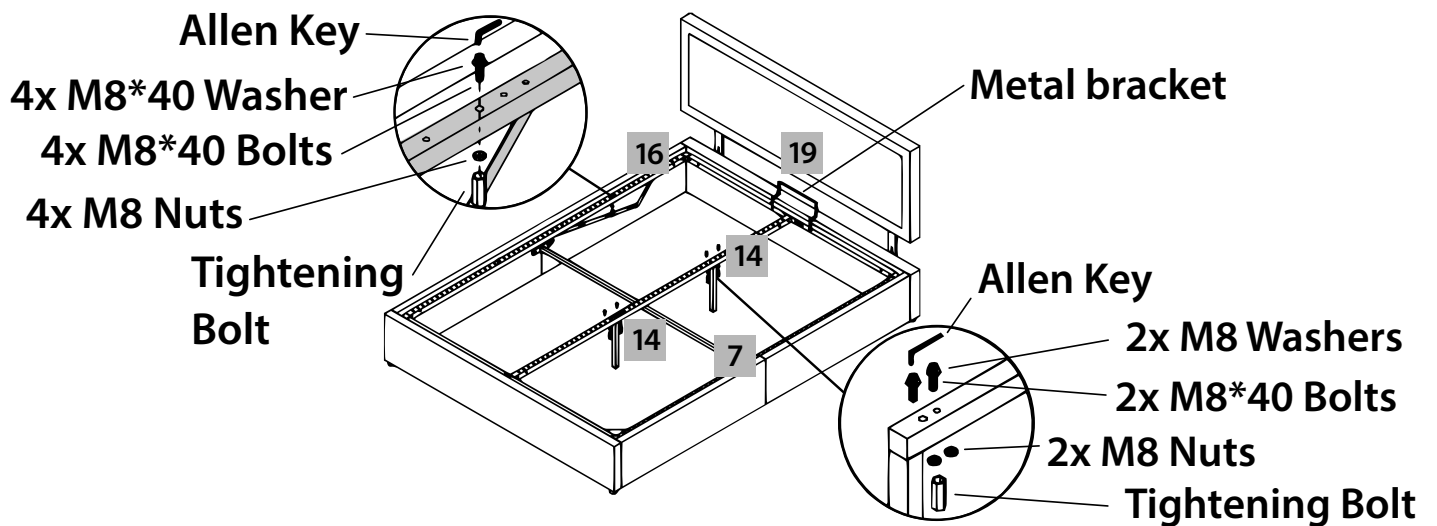

STEP 9

WHAT YOU NEED:

- 11-12x Centre Slat Caps
- 22-24x Side Slat Caps
- 22-24x Wooden Slats

INSTRUCTIONS

- Attach centre slat caps and side slat caps to each wooden slat as shown in illustration.
- Attach the assembled slats to metal frame by firmly pushing into place on the slat frame.
- Finally attach belt to the metal frame by loop-on method as shown.

Side Slat Caps

Wooden Slats

Center Slat Caps

DISCLAIMER:

Depending on the size of your bed the number of parts for the Slats, Centre Slat Caps & Side Slat Caps may vary.

Centre Slat Caps:

King - 12x, Double - 11x, Small Double - 11x, Single - 11x

Side Slat Caps:

King - 24x, Double - 22x, Small Double - 22x, Single - 22x

Wooden Slats:

King - 24x, Double - 22x, Small Double - 22x, Single - 22x

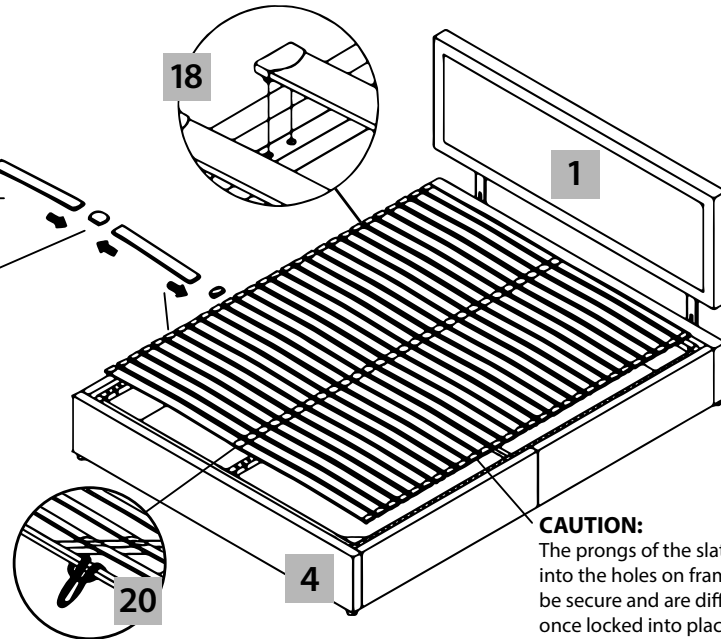

CAUTION:

The prongs of the slat caps, that lock into the holes on frame are made to be secure and are difficult to remove once locked into place

STEP 10

WHAT YOU NEED:

- 2x Pistons
- 4x M8 Nuts

INSTRUCTIONS

- Attach the Pistons onto both the lifting mechanism. Ensure that the heavier end is positioned at the bottom.
- Using M8 Nuts secure the pistons at each end onto the lifting mechanism
- Repeat process on the other side.

Lifting Mechanism

Piston

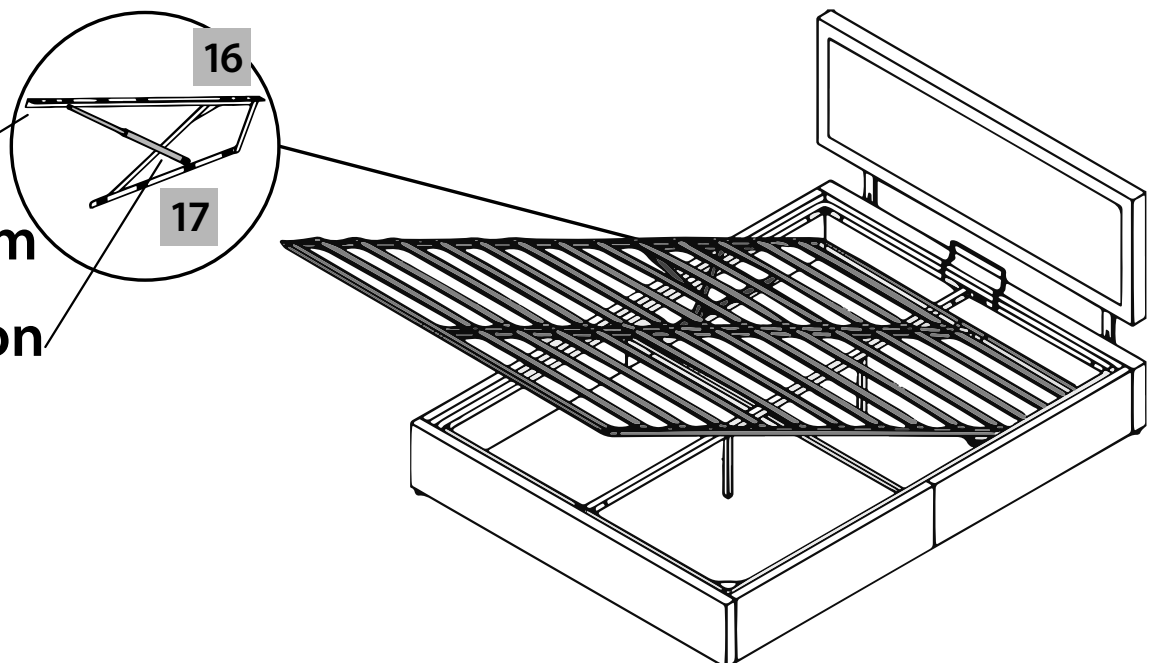



FURNITUREFUL

WHAT'S YOUR FURNITURE STORY?

THANK YOU
FOR YOUR BUSINESS

ENJOY **15%** OFF
YOUR NEXT PURCHASE

USE CODE:

THANKS15

AT CHECKOUT ON OUR WEBSITE

www.furnitureful.com