



PUFFCO

SHARE THE VIEW:

Use **#PuffcoPeak** to share your experience. We'll share your photos and videos with our global audience (seriously we will).



YOU'RE ALMOST TO THE TOP!

We know it's a drag, but please read through all the directions. This device is the first of its kind, and we'd like you to learn the easy way by reading this booklet. You'll learn some secret tips and tricks as well!

- *Whats inside / p 3*
- *Quick start / p 4 - 8*
- *Temperature settings / p 9*
- *Battery / p 9*
- *Cleaning your device / p 10*
- *Advanced features / p 11*
- *Warning / p 11*
- *Peak Protection / p 12*

WHAT'S INSIDE:

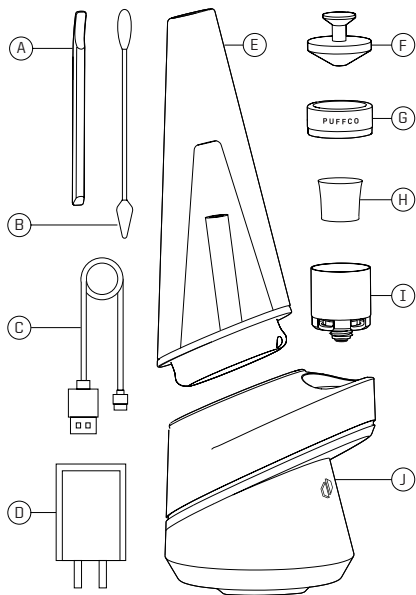

- | | |
|----------------------|---------------------|
| A: Loading tool | F: Carb cap* |
| B: Cotton swabs | G: Atomizer cover |
| C: USB cable | H: Ceramic bowl (2) |
| D: AC adapter | I: Atomizer |
| E: Glass attachment* | J: Base |

*Each glass piece is hand blown, and may vary slightly in size.

QUICK START:

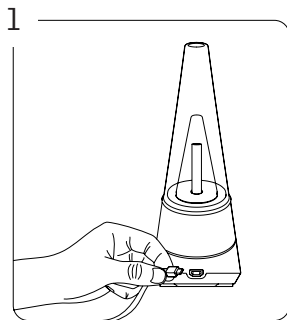

STEP 1: Fully charge device before first use.
Device pulses white while charging, and turns off automatically when complete.

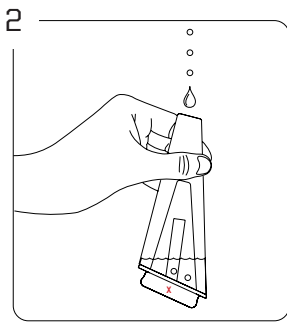

STEP 2: Fill glass with water just above the air-holes. Do not fill glass while attached to base.
X - Do not allow water in lower section!

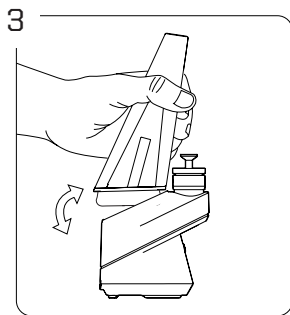

STEP 3: Align inlet hole on the front of the glass with atomizer. Carefully push the front of glass into the base, then the back.

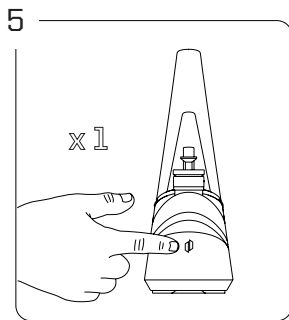

STEP 5: Single click to toggle through heat settings.
BLUE / 450 ° - **GREEN** (Medium) / 500 °
RED (Large) / 550 ° - **WHITE** (XL) / 600 °

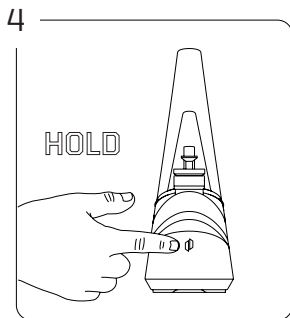

STEP 4: To lock / unlock the device, hold down the button for 3 seconds.

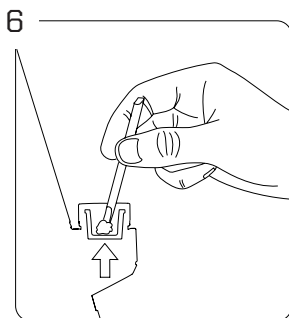

STEP 6: Use Loading tool to place contents on the bottom surface of the bowl (not the side).

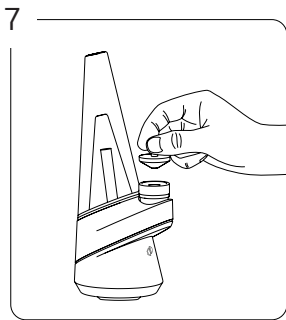

STEP 7: Place carb cap on top of atomizer.

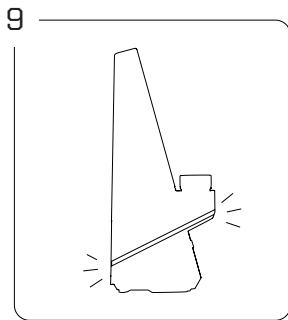

STEP 9: Device will vibrate and lights will flash 3 times when ready. Inhaling gently will produce the best results. *See p. 11 for sesh mode.

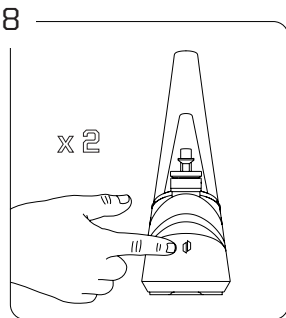

STEP 8: Double click to initiate heat-up (20 second avg. heat-up time). Press and hold button anytime to exit. Pulsing light indicates heat-up mode is active.

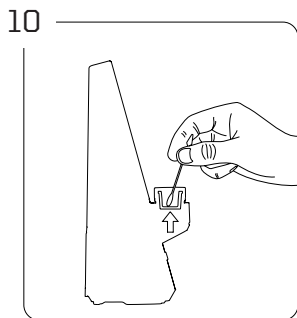

STEP 10: Use a cotton swab to clean the chamber after each use.

TEMPERATURE SETTINGS:

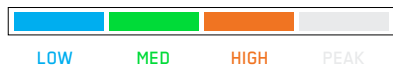

To cycle through the 4 temperature settings, click the button once.

- LOW** (Small load) / 450° → 20 sec. heat up
- MEDIUM** (Medium load) / 500° → 20 sec. heat up
- HIGH** (Large load) / 550° → 25 sec. heat up
- PEAK** (XL load) / 600° → 25 sec. heat up

The Peak device features intelligent temperature calibration, which provides a more consistent experience during repeated use. This means that all heat up times vary.

BATTERY:

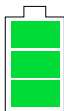

100% - 60%



60% - 30%



15% - 0%

Click the button 3 times to check battery life. Color will indicate remaining battery life.

Battery fully charges in approximately 2.5 hours.

CLEANING:

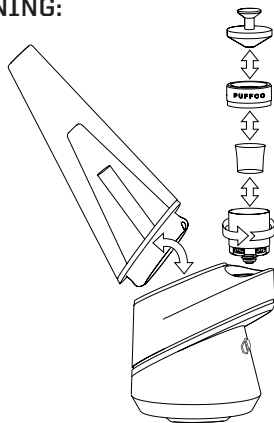

Preparation: Remove glass before unscrewing and re-inserting atomizer (fully tighten down before use).

1. Clean carb cap and glass by soaking in isopropyl alcohol. Rinse clean with water after.
2. Atomizer can be cleaned with iso fully assembled or disassembled. Be sure to clean gold connector on base and bottom of atomizer with an alcohol soaked cotton swab.
*If your bowl cannot be easily removed, do not attempt to forcefully remove it. See online instructions at Puffco.com, or contact support immediately.

3. **WARNING:** After cleaning, allow all parts to thoroughly dry before use.

- *Before removing atomizer, make sure bowl has cooled.
- *Do not get the base wet - it's electric - it will break.
- *Thoroughly clean device every 20 uses.

Sesh Mode:

Haven't reached your peak? We got you covered. We created a sesh mode that increases heat and extends your session by 15 seconds. Use it to boost heat, or to share with your friends.

If vapor production is low, double click to initiate sesh mode. Still not enough? Damn you're hardcore, sesh again! You can double click as many times as you want to keep the session going.

WARNINGS: 

Multicolored light flash: Indicates poor or no connection between the base and atomizer.

3 red flashes: Indicates low battery.

5 light flashes: Indicates short circuit.

Red light holds: Device overheated.

- Do not allow water in the bottom chamber of glass.
- Do not let water seep into the atomizer.
- Do not overfill glass.
- Do not store device with water in the glass.
- Remove glass before unscrewing and inserting atomizer.
- Attach / detach glass carefully, do not force.
- Wait 1 minute between uses.
- Do not fire atomizer 4 times consecutively.
- Several short inhales produce more vapor.
- Do not place contents on the sidewalls of the bowl.
- Do not overfill chamber.
- If you experience a bug, turn the device on and off. Should the issue persist, contact support.
- Keep away from extreme hot and cold temperatures.
- Keep away from moisture and high humidity.



- PUFFCO QUALITY GUARANTEE -

PEAK PROTECTION:

We want to make sure you have a consistently perfect experience. Should something go wrong, visit Puffco.com to view FAQ's (your question might be covered there). If not, you can livechat with a specialist on our site or contact customer care at Support@Puffco.com.

Puffco One-Year Limited Warranty Summary:

Puffco provides one year of coverage for only the electronic base. This covers defects in materials and workmanship for one year from the date of original retail purchase. Puffco does not warrant glass, atomizers, normal wear and tear, or damage caused by accident or abuse. To obtain service, email Puffco customer care at Support@Puffco.com or visit <https://Support.Puffco.com/hc/en-us>. Call charges and international shipping charges may apply, depending on the location. Subject to the full terms and detailed information listed on Puffco's website under local consumer laws. You may be required to furnish proof of purchase details, and the device itself when making a claim under this warranty. Do not attempt to open the Puffco Peak base, this will immediately void the warranty for your product.

 Support@Puffco.com

LEGAL:

For all Puffco products, strictly use as intended. Puffco units should be used only by persons of legal age in congruence with state and or federal law.

Know that Puffco reserves the right to verify the age of the consumer prior to every purchase.

Registered Puffco products are not intended for any use which is illegal under any state or federal law.

Moreover, Puffco products aren't intended to diagnose, prevent, treat, or cure any disease or medical condition. If you are pregnant, nursing, taking medication for a medical condition, or suspect you have a medical condition, please consult your physician before using any Puffco product.

This device complies with Part 15 of the FCC Rules. Operation is subject to the following two conditions: (1) this device may not cause harmful interference, and (2) this device must accept any interference received, including interference that may cause undesired operation.

Thank you for choosing Puffco. Welcome to the family. Puffco products are designed and engineered in Brooklyn, NY and assembled in China.



SHARE THE VIEW:

Use **#PuffcoPeak** to share your experience.

Kindly follow us on instagram!





13-352-11111

by Puffco Creation Labs - Subject to alterations · All rights reserved