

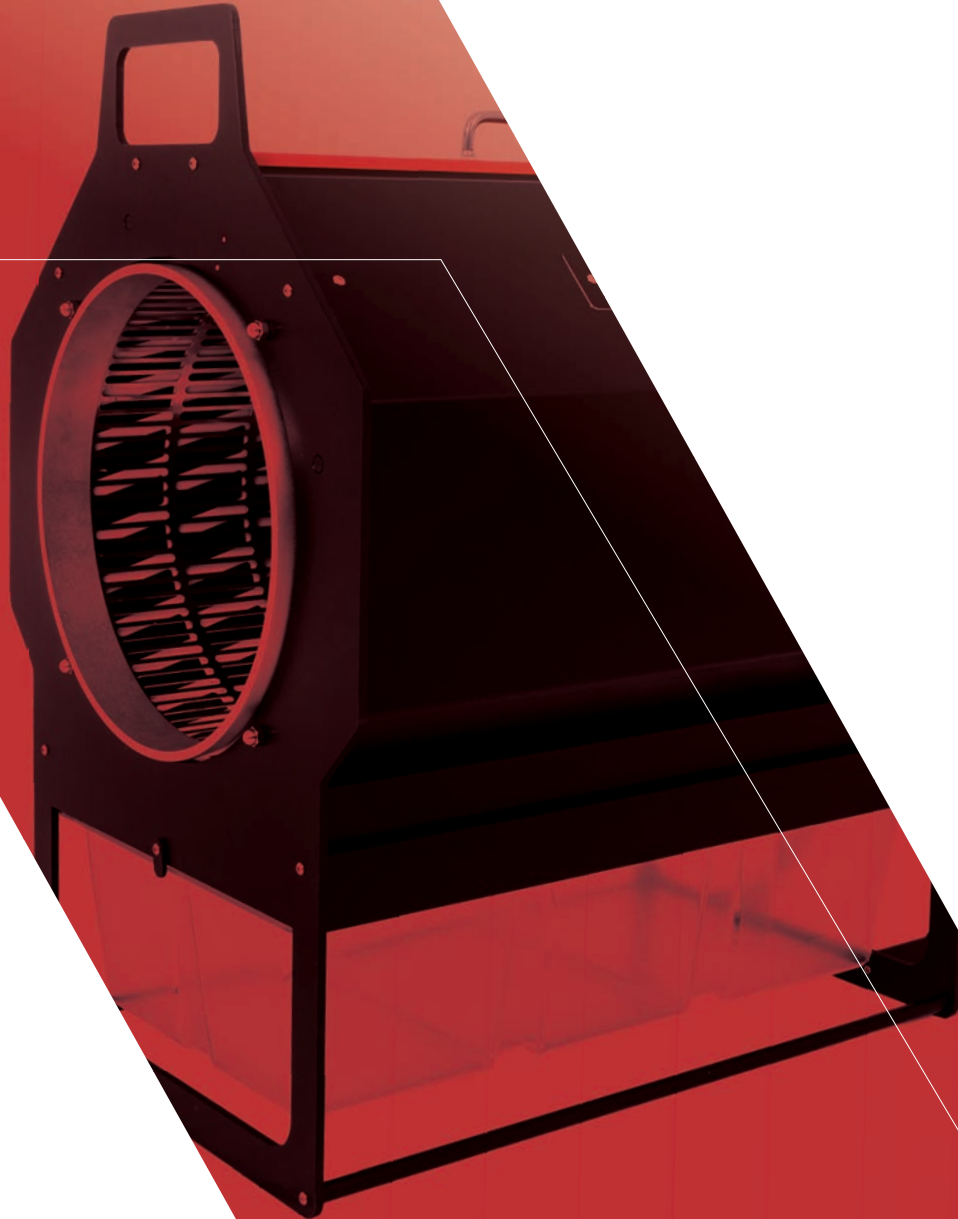

CENTURIONPRO

ELITE TRIMMING TECHNOLOGIES



OWNERS MANUAL

DBT MODEL 2

WITH VARIABLE SPEED CONTROL

!! IMPORTANT !!

WARRANTY

YOU MUST REGISTER YOUR TRIMMER WITHIN 30 DAYS OF YOUR PURCHASE

YOU HAVE JUST MADE A SMART DECISION BY PURCHASING THE BEST TRIMMER IN THE WORLD. FAILURE TO REGISTER YOUR MACHINE WITHIN 30 DAYS OF PURCHASE WILL VOID YOUR 10 YEAR WARRANTY. PROTECT YOUR INVESTMENT. THIS PROCESS WILL ONLY TAKE 3 MINUTES TO COMPLETE.

REGISTER NOW!



cprosolutions.com/warranty

WARRANTY TERMS AND CONDITIONS

CenturionPro Solutions (the manufacturer) will repair or replace, without charge, any parts proven defective in material or in workmanship for a period of 3 years on the Trimming Machine and 2 years on the Variable Speed Control.

The warranty period will begin on the date the machine(s) is purchased by the initial purchaser. Product or component warranty defects can be remedied at any authorized service dealer, or directly at the manufacturer. Any service work performed, and deemed valid due to a defective part, will be free of charge. CenturionPro Solutions reserves the right to use any manufacturer-approved replacement part for the warranty repair.

The machine or defective part then must be returned to the manufacturer for analysis or replacement at the cost of the owner. Parts deemed to be covered under the warranty will be provided for free excluding shipping costs.

Do not return the machine to the place of purchase for repair or warranty claims, unless you have been authorized by CenturionPro Solutions to do so. The place of purchase can only sell replacement parts and will not repair any warranty issues, unless it is noted as an authorized repair dealer and has been authorized to work on your machine.

IF WARRANTY REPAIR IS REQUIRED, PLEASE CONTACT THE MANUFACTURER AT 1-855-535-0558 OR techsupport@cprosolutions.com AND PROVIDE THE FOLLOWING INFORMATION:

- 1. Model and serial number - Located on outside of motor**
- 2. Proof of purchase date**
- 3. A copy of the original Warranty Registration Card or Online Submission**
- 4. Details of the defect or problem (include photos and videos)**

YOU MAY BE DENIED WARRANTY COVERAGE IF YOUR MACHINE HAS FAILED DUE TO ANY OF THE FOLLOWING:

Product abuse	Normal wear
Product neglect	Accidental damage
Improper maintenance	Unapproved modifications
Improper electrical connection	Water Damage

LIABILITIES

The manufacturer assumes no risk and shall be subject to no liability for damages or loss resulting from the specific use or application made of the product. In no event will the manufacturer be liable for any special, incidental or consequential damages (including loss of use, loss of profit and claims of third parties) however caused - whether by negligence of the manufacturer or otherwise. If you have any questions regarding your warranty rights and responsibilities, please contact the manufacturer.

LEGALITIES

CenturionPro trimming machines are intended for use on legal aromatic herbs and hops. Please check all municipal, provincial/state and federal laws and regulations before using these machines. CenturionPro Solutions does not promote or condone the use of these products in any way that may be deemed illegal. Allow only persons who understand this disclaimer to operate the machines.



IMPORTANT SAFETY INFORMATION

CENTURIONPRO SOLUTIONS: DBT MODEL 2 WITH VARIABLE SPEED CONTROL AUTOMATED TRIMMING SYSTEM

DO NOT LEND OUT OR RENT YOUR DBT MODEL 2 WITHOUT THIS OPERATING MANUAL. A FIRST TIME USER SHOULD OBTAIN PROPER INSTRUCTION PRIOR TO USE.

The DBT Model 2 is a high-speed trimming system, requiring that specific safety precautions are practiced during operation to reduce the risk of personal injury. Improper use of the DBT Model 2, or any CenturionPro product, may cause serious or fatal injury. Please ensure you read the operations manual and warning notes before using the DBT Model 2 with Variable Speed Control.

GENERAL

- Do not move, disassemble, clean or inspect the trimmer while the power is still connected to the machine.
- Replacement parts are specific to DBT Model 2 and must be purchased from an authorized dealer only. Substituting factory parts with non-approved third-party replacements may result in damage to the machine or bodily harm.
- Keep all individuals a safe distance from the work area. Do not operate the machine around children.
- Do not remove safety labels. Replace any and all labels if they become damaged or obscured.

CONNECTION

- As with home appliances, the DBT Model 2 must be used in connection with a properly grounded receptacle.
- Never plug in or power up your trimming machine if the protective shrouds are removed.
- Do not use extension cords over 8m (25ft) in length to power the DBT Model 2.

OPERATION

- The initial set up will show assembly instructions to unpack and set-up your machine.
- Safety glasses should be worn at all times while operating the DBT Model 2.
- Do not operate any trimming machine while tired or under the influence of medication, drugs or alcohol.
- Do not put anything other than plant material into the tumbler. Doing so may cause damage to the tumbler, the machine or result in bodily harm.
- Operate the trimmer in a well ventilated area in order to prevent overheating.

MAINTENANCE

- Never leave the DBT Model 2 system running unattended.
- Never conduct maintenance or cleaning while the machine is plugged in.
- Do not modify or adapt any part of the trimmer or its accessories. Doing so may cause irreversible damage to the machine or result in bodily harm.

DBT MODEL 2 - WITH VARIABLE SPEED CONTROL

DBT MODEL 2 - WITH VARIABLE SPEED CONTROL	
Input Voltage (w/VFD)	1.2 Amp - 110V NA
	0.6 Amp - 220V EU/AUS
Dimensions (L x W x H)	31in x 19in x 29in 79cm x 48cm x 74cm
Weight	65 lbs / 29 kg
Tumbler Diameter	13in / 33cm
Tumbler Length	23in / 59cm
Number of Tumblers	1
Processing Capacity (per hour)	Dry: 20 lbs / 9 kg
Motor	1/8 HP
Warranty	3 years
VSC Warranty	2 years

ELECTRICAL POWER SUPPLY SET-UP

TEST YOUR ELECTRICAL CURRENT TO MAKE SURE IT IS PRODUCING POWER. **WE RECOMMEND HAVING A CERTIFIED ELECTRICIAN SET UP THE PROPER POWER SUPPLY.** THIS WILL ENSURE YOUR POWER SOURCE IS SUPPLYING THE CORRECT ELECTRICITY. IF YOU HAVE NOT DONE THIS, HAVE A CERTIFIED ELECTRICIAN COME AND TEST YOUR ELECTRICAL CURRENT.

DBT MODEL 2 - ADDITIONAL REQUIREMENTS	
EXTENSION CORD	14 AWG (min AWG SIZE)
	7.6m/25ft MAX LENGTH



TABLE OF CONTENTS

WARRANTY	2
IMPORTANT SAFETY INFORMATION	3
SPECIFICATIONS	4
TABLE OF CONTENTS	5
BEFORE YOU START	6
COMPONENT OVERVIEW	7
TRIMMING PLANT MATERIAL	8
CLEANING & MAINTENANCE	9
CLEANING & MAINTENANCE - DISASSEMBLE	10
CLEANING & MAINTENANCE - RE-ASSEMBLE	11
KIEF FILTER SCREEN UPGRADE	12
TRIMMER SAFETY	13
TROUBLESHOOTING	14
FREQUENTLY ASKED QUESTIONS	15
RETURN/REFUND POLICY	15
ADDITIONAL ASSISTANCE	15



WITNESS THE RISE

RELIABLE • INDUSTRIAL • SIMPLE • EFFICIENT

CONNECT POWER CORDS

1. Connect the DBT Model 2 power cord to a 15 amp 120 VAC circuit. Do not connect and disconnect the power cord with wet hands. Do not operate in the rain.

STARTING THE MACHINE

1. Flip the MOTOR SWITCH to the ON position.
2. Turn the TUMBLER SPEED dial clockwise to set the desired speed, start off at the lowest setting and increase as required.

STOPPING THE MACHINE

NOTICE: In an emergency, turn the motor switch to the OFF position.

1. At any other time, turn the TUMBLER SPEED dial counter-clockwise, until it aligns with the ZERO.
2. Turn the MOTOR SWITCH to the OFF position.

DISCONNECT POWER CORDS

1. Disconnect the trimmer's power cord.

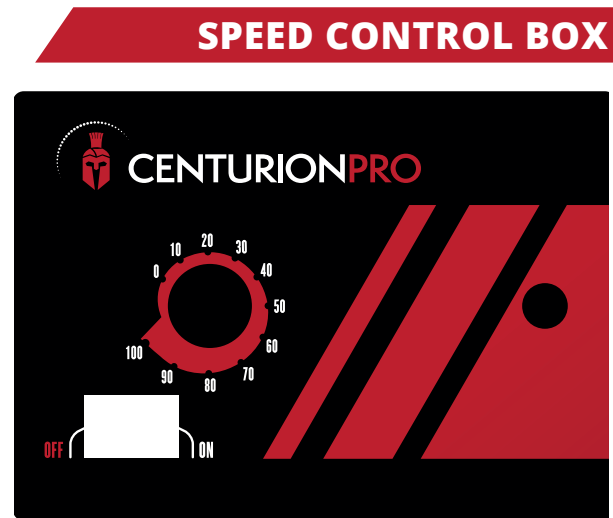

NOTICE: Be sure to hold the plug when disconnecting power cord from electrical outlet. Do not disconnect by pulling on the power cord.

CONTROLS AND COMPONENTS

BEFORE OPERATION

Read and understand this manual. Educate yourself on the location and operation of the controls. Familiarize yourself with the trimmer and how it works before you begin using it. Know how to quickly shut off the machine in case of an emergency.

Your safety is your responsibility.

PRE-OPERATION CHECK

For your safety, and to maximize the service life of your equipment, it is very important to take a few moments before you operate the trimmer to check its condition before each use. If you happen to come across any issues, be sure to take care of them before you operate the trimmer.

Improperly maintaining this trimmer, or failing to correct a problem before operation, could cause a malfunction which could cause you to be seriously injured. Always perform a pre-operation inspection before each use, and correct any problem.

Before beginning your pre-operation checks, be sure the trimmer is on a level surface, the MOTOR SWITCH is in the OFF position, and all power cords are unplugged.

CHECK THE GENERAL CONDITION OF THE TRIMMER

Clean the Tumbler, Blade Sheet, and tension system. Look for signs of damage.

Check each control for proper operation.

Check parts for wear. Replace if necessary.

Check that all nuts, bolts, and clamps are tightened appropriately.

NOTICE: Keep all shields, Trim Trays and covers in place while operating the trimmer.



COMPONENT OVERVIEW

OWNERS MANUAL

MODEL 2 DBT

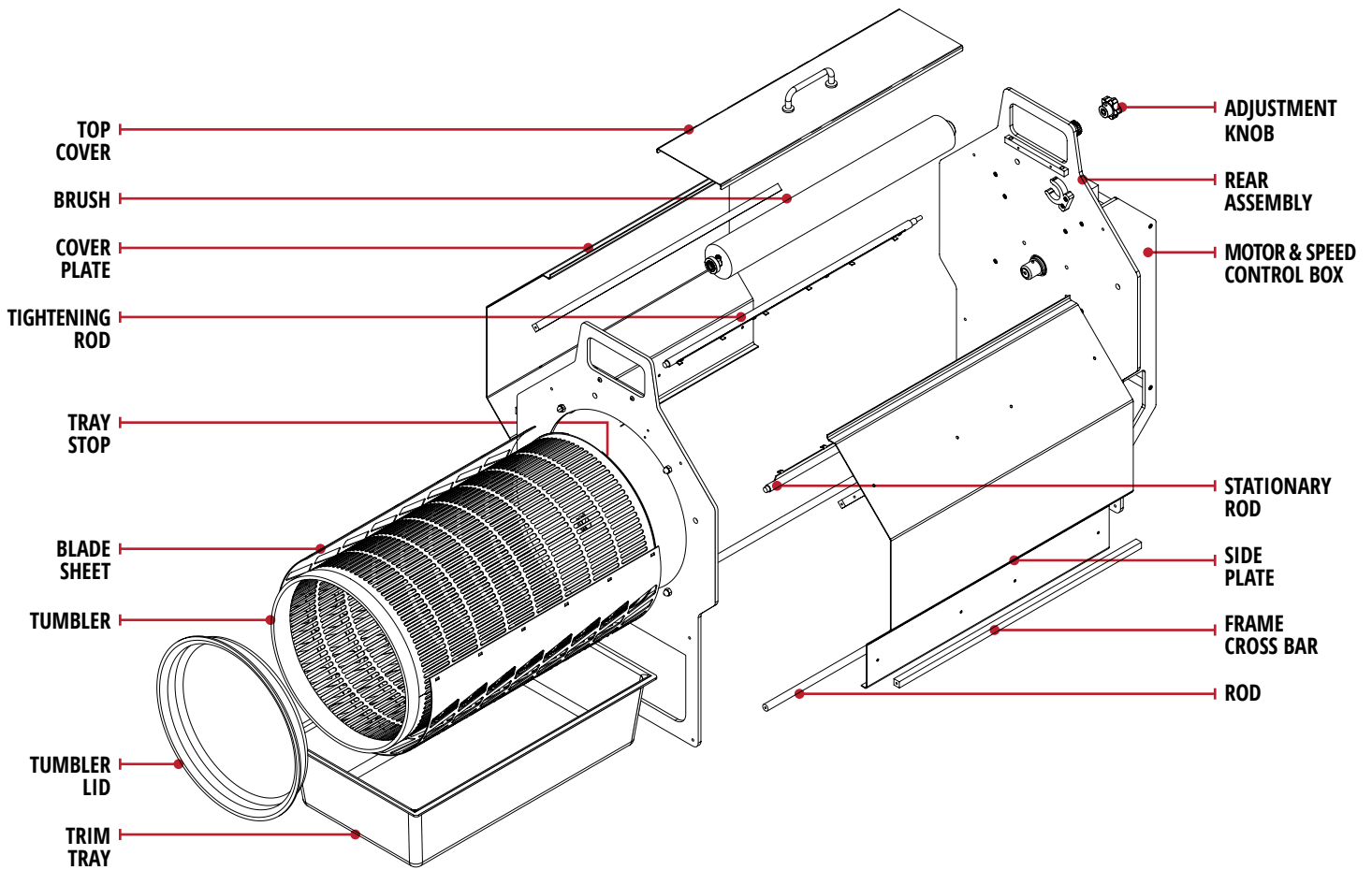
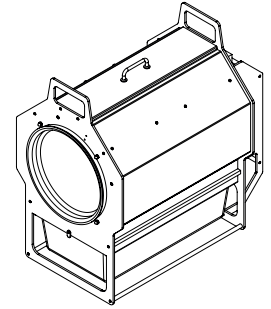

110V North America
220V Australia EU

**LEARN
HOW NOW**

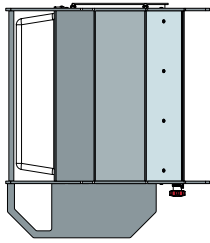

LOAD

Remove clear Tumbler Lid from front of Tumbler. Use handles to roll machine into a vertical and upward facing position. Load dried, prepped, untrimmed plant material into the Tumbler. For best efficiency, fill Tumbler 40-60% full and run batches of similar material.

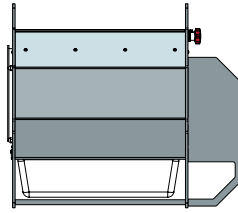

RUN

Re-apply clear tumbler lid. Use handles to roll machine into a horizontal position. Tighten Blade Sheet as required. Re-apply clear tumbler lid. Turn machine ON and allow to run for 1-15 minutes. Check material every 2-5 minutes. For a closer trim, continue running the DBT Model 2 until desired trim is accomplished.

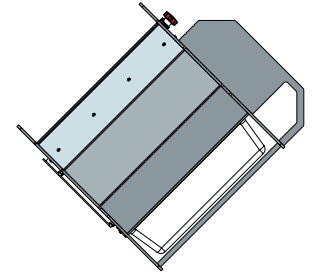

EMPTY

Once desired trim is accomplished, remove Trim Tray & Tumbler Lid, position separate container (not included) to capture processed materials. Use handles to tilt machine into a downward facing position. Processed material will be deposited in the container when correctly positioned.

Empty Trim Tray:

Lift the Tray Stop on the front of the machine to release the Trim Tray. Slide Trim Tray out of slots, empty tray and replace.



IMPORTANT NOTE:

TRIM TRAY SERVES AS A COLLECTION MECHANISM AND AS A SAFETY GUARD. MACHINE SHOULD NOT BE RUN WITHOUT TRIM TRAY IN PLACE AND TABS ORIENTED IN THE VERTICAL POSITION.

SERVICING YOUR TRIMMER

Proper maintenance is essential for safe, economical, and trouble free operation.

Other service tasks that are more difficult, or require special tools, are best handled by professionals and are normally performed by a Centurion Pro technician or other qualified mechanic. The maintenance schedule applies to normal operating conditions. If you operate your trimmer under severe conditions, such as sustained high load or high temperature operation, or use it in unusually wet or dusty conditions, consult your servicing dealer for recommendations applicable to your individual needs and use.

Remember that an authorized Centurion Pro servicing dealer knows your trimmer best and is fully equipped to maintain and repair it. To ensure the best quality and reliability, use only new, Centurion Pro parts or their equivalents for repair and replacement.

NOTICE: Improper maintenance, or failure to correct a problem before operation, can cause a malfunction which can cause serious injury or death. Always follow the inspection and maintenance recommendations and schedules in this owner's manual.



IMPORTANT NOTE:

MOTOR & SPEED CONTROL BOX ARE NOT WATERPROOF. DO NOT GET WET. REMOVE WHEN NECESSARY



**LEARN
HOW NOW**

The DB T Model 2's are precision machines. It is essential that they be operated and maintained with this in mind. It's important to inspect the machine at initial start-up and after each use to ensure that no damage or plant material build-up has occurred and that the tumbler spins freely.

In addition, it is highly recommended to clean the machine after every day of use. This ensures that the Blade Sheet and Tumbler are kept lubricated and that resin does not build-up and affect performance. This is especially important if the machine has been stored for an extended period of time.

CLEANING

Remove Tumbler and Blade sheet and cover with a thick coat of cooking oil (olive, vegetable, etc.). Let sit for 3-12 hours. Using warm/hot water, concentrated dish soap and a non-metallic dish scrubber, clean the Tumbler and other machine components by hand. Alternatively you can pressure wash with hot water, at up to 1500 psi on fan spray setting. After pressure washing, run machine for 15 minute to allow components to dry.

Read full **CLEANING AND MAINTENANCE** instructions before cleaning.

When to Clean:

Depending on the material being processed and the frequency of use, the slots of the Tumbler may need to be cleaned after each use or periodically. Indications that machine requires cleaning

- Reduced trim quality
- Visible build-up of material in the Tumbler slots which obscure the sharp edge of the slots
- Visible evidence of material on Blade Sheet
- Excessive noise (machine should run quietly so that you may converse normally when it is running)

REMOVING OBSTRUCTIONS

If the rotating Tumbler becomes restricted or clogged:

Stop the motor and make sure that all rotating parts have come to a complete stop. Disconnect the trimmer's power cord. Use a wooden stick to clear the obstruction.

INTERVAL	ITEM
Before each use	Check that Blade Sheet is snug, and in contact with Tumbler and is tightened appropriately Check that machine is free of excessive debris. Ensure that machine is clean and the Tumbler can be rotated without power under manual force.
During use	Although not required, application of a food grade lubricant to Tumbler and Blade Sheet can help reduce resin build up.
After each use	For best performance and longevity, clean trimmer after every use or if plant material is visibly affecting the trim quality or speed of the trimmer.
Every 10 hours of operation	To maximize Blade Sheet life, rotate orientation of blade sheet every 10 hours or when visible signs of wear are identified. Although not required, this will extend the life of the Blade Sheet.

PRESSURE WASHING THE DBT MODEL 2

NOTICE: Motor & Speed Control Box are NOT waterproof. DO NOT GET WET. Remove when necessary. Avoid spraying the bearings (located at the ends of the brush). These components are not intended to be waterproof and water damage is excluded from warranty coverage. If you choose to use a pressure washer take care not to damage the trimmer's finish by holding the nozzle excessively close to the machine.

- Clean with pressure-washer at up to 1500 psi.
- Hot water, fan spray setting.
- Run for 15 mins after washing to allow components to dry.

STEP 1: CLEAN BRUSH

Simply pull on brush to remove. Clean the length of the brush of all debris using hot pressurized water.

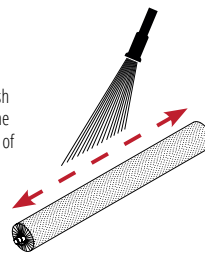

STEP 2: CLEAN ELECTROPLISH TUMBLER

Clean the length of the Tumbler of all debris using hot pressurized water.

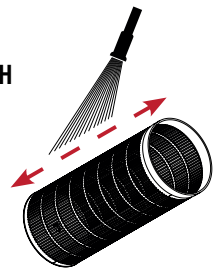

WARNING:
PINCH POINT HAZARD - WEAR GLOVES WHEN REMOVING BRUSH.
ALWAYS WEAR PERSONAL PROTECTIVE EQUIPMENT WHEN CLEANING MACHINE.



**LEARN
HOW NOW**

DISASSEMBLE

STEP 1:
SHUT OFF MOTOR. UN-PLUG POWER CORDS.

STEP 2:
REMOVE BRUSH:

- A. PUT ON GLOVES and, pull brush firmly to release from snap clips.

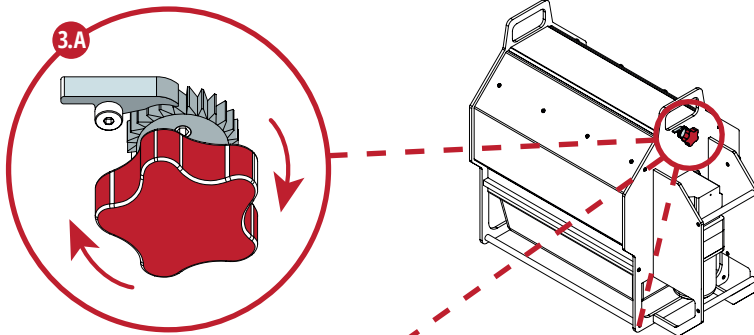

STEP 3:
RELEASE TENSION ON THE BLADE SHEET:

- A. Turn the tension adjustment knob clockwise slightly to release tension on the ratchet.
- B. While turning the tension adjustment as described above flip the pawl off of the ratchet so it is no longer in contact.
- C. Release the tension knob; the Blade Sheet will now hang freely within the trimmer.

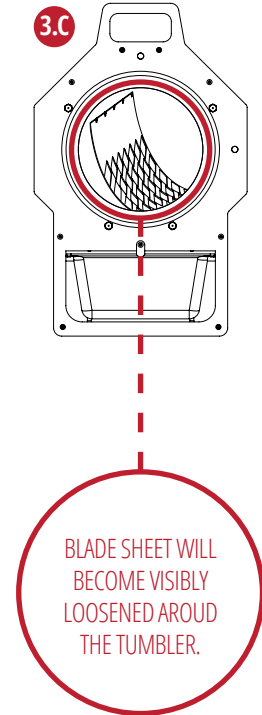
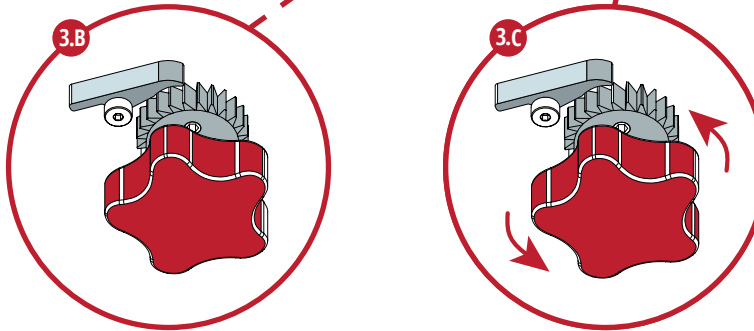

STEP 4:
REMOVE TUMBLER:

- A. To remove the Tumbler, roll the machine into a vertical position. Release the Tumbler by rotating it clockwise until it becomes freed from the dowel pins.
- B. Slide the Tumbler gently from the machine and set it on a non-abrasive surface. (Tip: If the Tumbler does not come out easily check that the Blade Sheet has been released as described in step 3.)

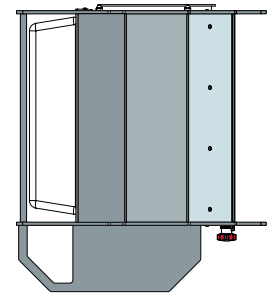
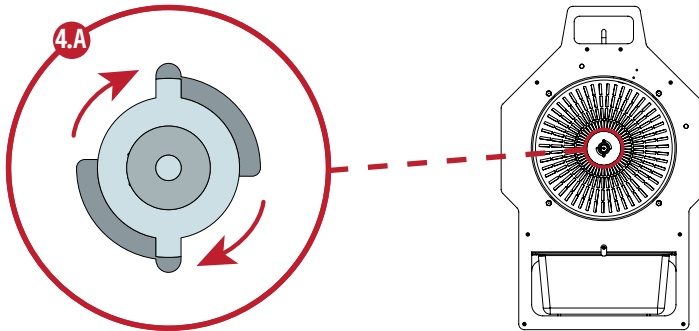

STEP 5:
REMOVE BLADE SHEET:

- A. Reach inside the machine and remove the Blade Sheet by gently lifting the Blade Sheet off of the metal tabs which hold it in place.
- B. Gently remove the sheet from the machine and place it on a non-abrasive surface.

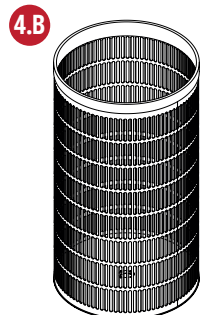
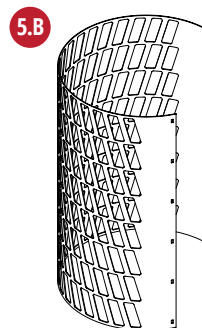
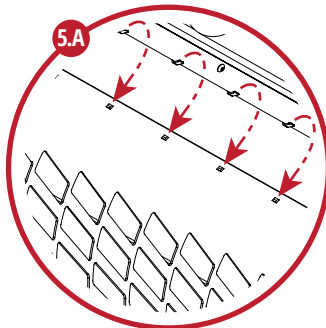

REASSEMBLE

BEFORE RE-ASSEMBLY

STEP 1: SOAK WITH COOKING OIL

- A. Cover entire Tumbler and Blade Sheet with a thick coat of cooking oil (olive, vegetable, etc). Let it sit for 3-12hrs.

STEP 2: USING WARM/ HOT WATER

- A. Using warm/hot water, concentrated dish soap and a non-metallic dish scrubber, clean the Tumbler and other machine components by hand.

NOTICE: For best results use hot water whenever possible. Be careful when selecting the degreaser that it will not damage the painted or anodized components of the trimmer. Always follow the operating instructions provided with the pressure washer.

STEP 1: SHUT OFF MOTOR. UNPLUG POWER CORDS.

STEP 2: INSTALL THE BLADE SHEET:

- A. Reach inside the machine and install the Blade Sheet by gently placing the sheet on the metal tabs until all holes are resting evenly on metal tabs on both sides of the machine.

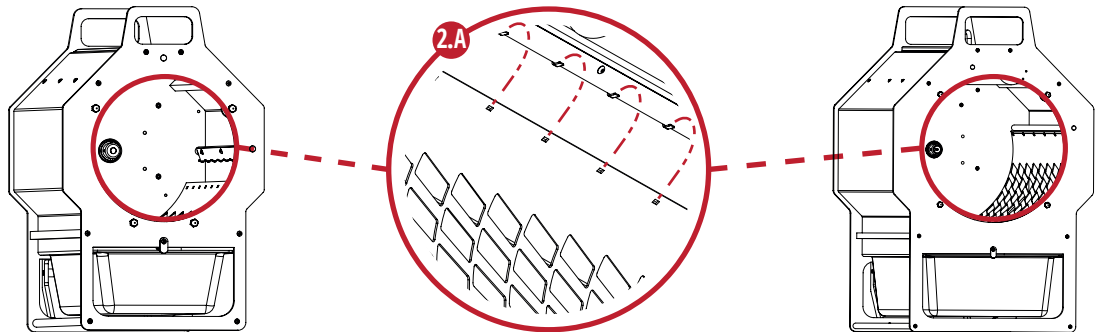

STEP 3: INSTALL THE TUMBLER:

- A. With motor off, power cord unplugged, and the machine in a vertical position, slide the Tumbler gently into the machine. Rotate Tumbler counter-clockwise to lock it in place.

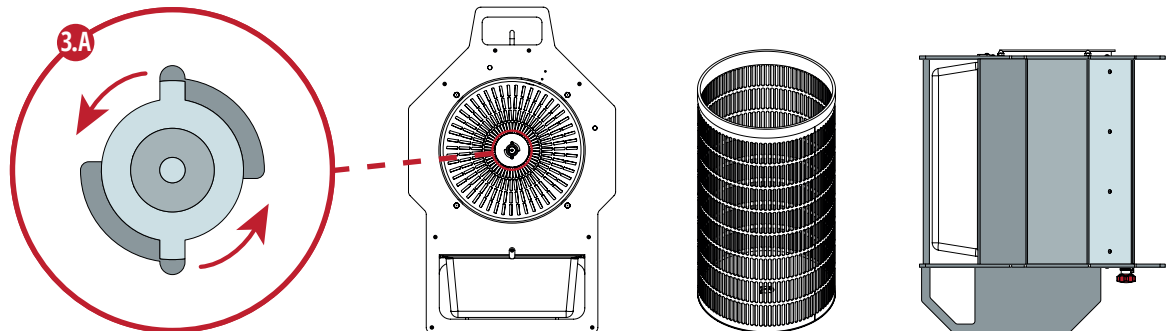

STEP 4: INSTALL BRUSH:

- A. Place Brush on the snap clips and firmly press into place.

STEP 5: RE-TENSION BLADE SHEET:

- A. Flip the pawl so it is in contact with the ratchet and prevents the ratchet from moving in a counter clockwise direction.
B. Turn tension adjustment knob clockwise slightly until you encounter minor resistance and the Blade Sheet has come in full contact with the Tumbler.

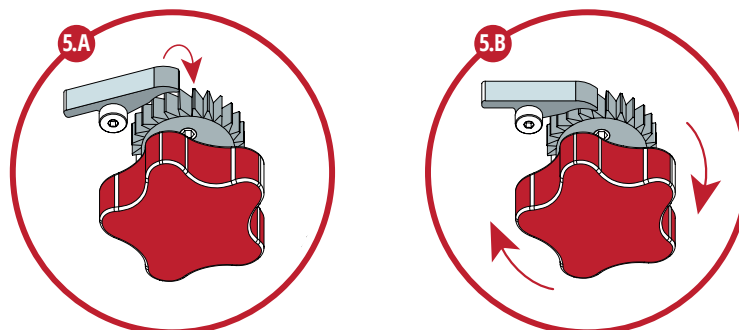

**IMPORTANT
NOTE:**
MOTOR & SPEED
CONTROL BOX
ARE NOT WATER-
PROOF. DO NOT
GET WET. REMOVE
WHEN NECESSARY.

MONTHS OF WORK CAN BE RUINED IN A FEW HOURS AT THE END SO PLEASE BE PATIENT AND TAKE YOUR TIME WITH THE HARVESTING AND CURING PROCESS.

KIEF FILTER SCREEN UPGRADE

PREPARATION

NOTICE: Make sure all motors are off and power cords are unplugged before you begin.

- Before setting up your Kief Filter Screen Upgrade with your trimmer, be sure to read and understand entire manual.
- Refer to CLEANING & MAINTENANCE (pg 10 & 11) for DISASSEMBLE & REASSEMBLE instructions.

STEP 1: LOOSEN BLADE SHEET:

Refer to DISASSEMBLE instructions on (pg 11).

STEP 2: REMOVE TUMBLER:

Refer to DISASSEMBLE instructions on (pg 11).

STEP 3: REMOVE BLADE SHEET:

Refer to DISASSEMBLE instructions on (pg 11).

STEP 4: INSERT FILTER SCREEN:

With motor off, power cord unplugged, and machine in a vertical position, slide Filter Screen gently into machine. Rotate Filter Screen counter-clockwise to lock.

NOTE: Failure to keep hooks on Tightening Rod, away from Filter Screen can result in damage.

STEP 5: FILL FILTER SCREEN:

With Kief Filter Screen in place and machine in a vertical position, take your trim and fill Filter Screen 1/2 up to 3/4 of the way full, then insert Tumbler Lid.

NOTE: Overfilling will lower quality and processing speed.

STEP 6: RUNNING MACHINE:

Rotate the Trimmer into a horizontal position and turn machine ON. Run materials for up to 10 minutes.

NOTE: If you wish to separate the different Kief qualities, run for 5 minutes, remove first batch of Kief. Then run for another 5 minutes.

STEP 7: REMOVE KIEF FILTER SCREEN:

- Carefully remove Kief Filter Screen.
- Brush excess kief off the inside ledges which hold Trim Tray in place.
- Carefully remove Trim Tray and brush Kief remaining on filter, into the Trim Tray.

NOTE: If you wish to separate the different Kief qualities, run for 5 minutes, remove first batch of Kief. Then run for another 5 minutes.

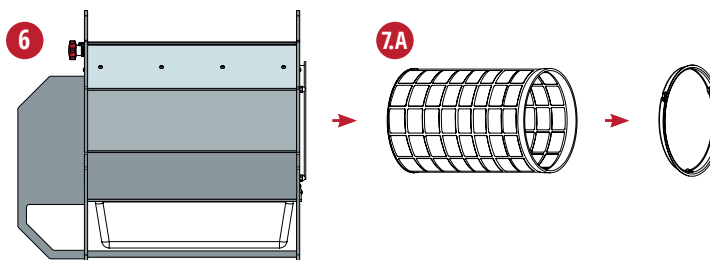
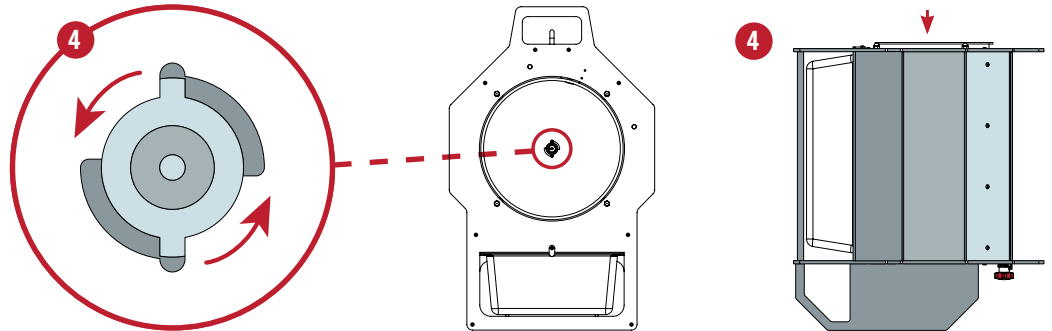

ALWAYS HAVE TRIMMER IN A HORIZONTAL POSITION WHEN RUNNING

CLEANING

HAND CLEAN WITH SOAP AND HOT WATER WHEN YOU NOTICE OUTPUT DIMINISHING

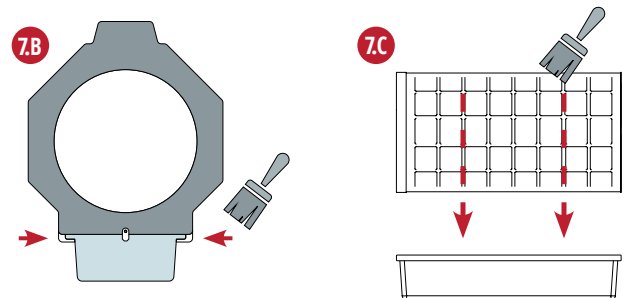

IDEAL RATIOS FOR DRY ICE KIEF FILTERING

NOTICE:

- Dry ice must be in pellet form or finely crushed.
- Large chunks of Dry Ice will damage the filter screen.
- Allow product to get really cold. Approx. 5-10 minutes.

TRIM	70%	TRIM	80%
DRY ICE	30%	DRY ICE	20%

TRIMMER SAFETY**IMPORTANT SAFETY INFORMATION**

We cannot warn you of every conceivable hazard that can arise in performing maintenance. Only you can decide whether or not you should perform a given task. Failure to properly follow maintenance instructions and precautions can cause you to be seriously hurt or killed. Always follow the procedures and precautions in this owner's manual. Centurion Pro trimmers are designed to trim excess plant material from a variety of herbal material. Other uses could result in injury to the operator or damage to the trimmer and other property. Injuries and property damage from trimmers can be prevented by following all instructions in this manual and on the trimmer. The most common hazards are discussed below, along with the best way to protect yourself and others.

Safety Precautions

Make sure all motors are off and power cords are unplugged before you begin any maintenance or repairs.
Read the instructions before you begin, and make sure you have the tools and skills required.

AVOID ROTATING TUMBLER

The DBT Model 2 Tumbler can cause serious injury, cuts and even amputate fingers or hands. Keep hands, arms, and body away from the Tumbler whenever the Tumbler is in motion. Keep hair, clothing, and jewelry away from the Tumbler. If you need to work around the trimmer to clear or clean plant material for any reason, always shut off the electric motor and disconnect the trimmer's power cord from the AC outlet. Use a wooden stick to remove any obstruction or debris. Never put your hand into the Tumbler while the machine is running; serious personal injury could result.

AVOID BLADE SHEET

The DBT Model 2's Blade Sheet can cause serious cuts and even amputate fingers and hands. Keep Trim Trays and Tumbler Lids in place at all times while machine is operating. If you need to work around the trimmer to clear or clean plant material for any reason, always shut off the electric motors and disconnect the trimmer's power cord from the AC outlet.

CLEAR OPERATION AREA

Before operating the trimmer, carefully inspect the surrounding area and remove all hazards that could cause you to trip, slip, or fall into the trimmer. Anything which can be grabbed by the rotating Tumbler is a potential hazard to you and others. Look for hazards and remove them from the work area. Tie back loose clothing and long, loose hair. Remove any and all jewelry.

KEEP GUARDS AND SHIELDS IN PLACE

Guards, Shields, Trim Trays and Tumbler Lids are designed to protect you from touching moving components. For your safety and the safety of others, keep all shields in place when the trimmer is running.

TURN MOTOR OFF WHEN NOT OPERATING THE TRIMMER

If you need to leave or step away from the trimmer for any reason, always make sure to turn the motor off.

OPERATE ON FLAT SURFACE

Do not operate on slopes. To avoid overturning, only operate the trimmer on flat surfaces. Control the trimmer carefully when transporting it across uneven ground or slopes. Do not push the trimmer down or across steep slopes: the trimmer could overturn, causing damage to the machine or injury to the operator and/or bystanders.

OPERATOR RESPONSIBILITY

Know how to stop the trimmer quickly in case of emergency. Understand the use of all trimmer controls. Never permit anyone to operate the trimmer without proper instruction. Do not let children operate the trimmer.

**SAFE OPERATING PRECAUTIONS**

- Before operating the trimmer for the first time, please review both the BEFORE YOU START section and the TRIMMER SAFETY section.
- Even if you have operated other trimmers, to take time to become familiar with how the Centurion Pro works.
- Never operate Centurion Pro machines while under the influence of drugs, alcohol or prescriptions, including over-the-counter cold/flu/allergy medications.
- Protective clothing and eye and/or hearing protection should be worn during operation.
- For your safety, do not operate while wearing loose fitting clothing, jewelry, etc..
- Rotating machinery parts can entangle loose clothing, long hair or dangling jewelry resulting in serious injury or death.
- Long hair should be secured in a manner that keeps it away from mechanical parts.

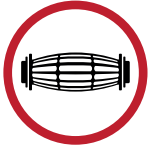

TUMBLER DOES NOT ROTATE UNDER MANUAL FORCE

- 1) Tumbler and Blade sheet are excessively dirty. Clean Tumbler and Blade Sheet; excessive plant material builds up on these surfaces and causes excess friction.
- 2) Tension on Blade Sheet is too tight. Reduce tension on Blade Sheet by releasing the pawl and rotating the tension knob in a counter clockwise direction until the Tumbler can easily be rotated under manual force and the Blade Sheet is in contact with the Tumbler.



ELECTRIC MOTORS WILL NOT START OR HAVE LOW POWER

- 1) No electric power from the outlet. Plug trimmer into a functional electrical outlet.
- 2) Outlet is overloaded. Check that breaker is not overloaded and has not tripped. If tripped, switch plug to a different circuit.
- 3) Extension cord is faulty. Check extension cord is rated appropriately for the distance and current (Pg 4). Undersized extension cords may cause an under-voltage, over-current condition which could damage or destroy the drive motor and void the motor warranty.
- 4) Overcurrent circuit has been exceeded. Determine cause of excessive circuit resistance which may include: overloaded outlet, faulty extension cord, bad outlet, underrated generator, excessively dirty machine, incorrectly tensioned Blade Sheet or obstruction between Tumbler and another part of machine. Once source of resistance has been identified and resolved, reset circuit by pressing small button on control panel for 3 seconds then operate machine normally.



THE CIRCUIT BREAKER KEEPS TRIPPING.

- 1) This is caused by a cord that is too long or undersized. Your cord must be no more than 25ft long and the same gauge of thickness as the main cord.
- 2) Also, ensure the machine is not sharing a circuit with other devices and the correct size breaker is present. Circuit sharing can significantly decrease the power being supplied to the devices therefore causing the breaker to trip.
- 3) Test your electrical current to make sure it is producing consistent power. We recommend having a certified electrician set up the proper power supply. This will ensure your power source is supplying the correct electricity. If you have not done this, have a certified electrician come and test your electrical current to ensure it complies with the electrical requirements.



MY TUMBLER IS NOT SPINNING.

- 1) If its not spinning, check for obstructions between Tumbler and Blade Sheet.
- 2) Ensure that the Tumbler is fully on the drive shaft with the drive pins engaging on the Tumbler plate.



THE PRODUCT IS NOT COMING OUT TRIMMED.

- 1) Tumbler and/or Blade Sheet are excessively dirty. Clean Tumbler and Blade Sheet.
- 2) Make sure that the Blade Sheet is tightened onto the Tumbler.
- 3) Check plant to make sure that moisture content is between 8-10% and that the leaves are snappy and dry, not bendy and pliable.



MY SIDE DRIVE IS HOT.

- 1) Your machine may be overworking due to a voltage drop in your power supply. This can happen if you're using an extension cord that is too long or undersized. You can only use an extension cord with a maximum length of 25ft.
- 2) Use a voltage tester to test your electrical current to ensure you have the correct voltage. We recommend having a certified electrician come in and make sure your power supply is consistent.
- 3) Having a motor on for an extended period can be the reason for overheating. Allow the motor to cool down by turning the machine off for an hour, every 5 hours of use.



MACHINE MAKES A LOUD SCRAPING OR CLICKING SOUND.

- 1) Tumbler and/or Blade Sheet are excessively dirty. Clean Tumbler and Blade Sheet.
- 2) Tumbler and/or Blade Sheet are damaged and need to be replaced.



**LEARN
HOW NOW**

HOW EASY IS IT TO CLEAN?

Please see the detailed cleaning instructions throughout this manual. Remove Tumbler and Blade Sheet and cover with a thick coat of cooking oil (olive, vegetable, etc.). Let sit for 3-12 hours. Using warm/hot water, concentrated dish soap and a non-metallic dish scrubber, clean the Tumbler and other machine components by hand. Alternatively you can pressure wash with hot water, at up to 1500 psi on fan spray setting. After pressure washing, run machine for 15 minute to allow components to dry. We recommend to clean your after every day of use, but it depends on your strain. We know the importance of down time during a harvest so we wanted to make this process as easy as possible.

ARE YOUR MACHINES BUILT TO AN INDUSTRIAL STANDARD?

We do not compromise quality for cost savings. All CenturionPro Solutions machines are composed of the highest quality materials available in North America and each machine is put through a comprehensive quality control inspection. We only use brand name components in the build out of our machines which enables us to have the comfort in giving you a 3 year trimmer warranty. With proper maintenance these machines will last you well over a decade.

HOW MUCH PRODUCT SHOULD BE IN THE TUMBLER AT ONE TIME?

The Tumbler should be 40-60% full when trimming.

WHAT IS THE MAINTENANCE LIKE?

We have several video tutorials on our website with how to fully service your machine. These step by step DIY videos make it very easy to do everything necessary to maintain your machine. All parts can be ordered through any hydroponic store nationwide.

WHAT IS THE OPTIMAL ROOM TEMPERATURE TO TRIM?

Use your CenturionPro machine in 50-60 °F (10- 15 °C) room to get the best performance. Cooler temperatures prevent excessive sticking to machine components.

WHY IS MY PRODUCT STICKING TO THE INSIDE OF THE TUMBLER?

If you find that product is sticking to the inside of the Tumbler, first clean the Tumbler. When you reassemble it, make sure the top brush bristles are poking through 1/4" into the Tumbler.

RETURN/REFUND POLICY

Once the machinery/parts are opened and/or used they are no longer eligible for refund or exchange. Customers can only return if written notice of return has been provided to CenturionPro Solutions within 7 days of receiving their machine and the machine or any component of which have not been used. There will be a 20% restocking fee and the customer will be responsible for all shipping costs. Returns must be packaged same as it arrived and CenturionPro is not liable for any shipping damage incurred on return. If damage occurs in transit on return, CenturionPro will refuse the return and customer will need to process a claim with their shipping provider. Any missing or damaged items must be reported to CenturionPro within 14 business days of receiving the shipment.

ADDITIONAL ASSISTANCE

You are about to enjoy the experience of CenturionPro Solution’s automated trimming machine. For critical information on assembly, cleaning, care, maintenance and how to operate your machine correctly, please review this manual and check out our video tutorials, which are posted on our website for your ease and convenience.

Go to www.cprosolutions.com/video-tutorials for our video tutorials.

These tutorials provide how-to assistance on the following aspects of machine maintenance:		
• Straightening the Tumbler/Drum	• Complete Unit Assembly	• Trimmer Cleaning and Maintenance
• Replacing The Motor	• Blade Sheet Removal and Cleaning	• DBT Harvest Workflow
**If for some reason you can't find an answer to your question online or in your manual, please do not hesitate to contact us.		

WITNESS THE RISE

RELIABLE • INDUSTRIAL • SIMPLE • EFFICIENT





**LEARN
HOW NOW**



CENTURIONPRO

ELITE TRIMMING TECHNOLOGIES

 cprosolutions.com

 1 855 535 0558

 sales@cprosolutions.com

FOLLOW US ON:

